

# General Catalogue



Quality made in



D946E193

# Index

Page

Contactor, Motor-Starters

Circuit Breakers

Manual Motor-Starters

Switches

AC-Main Switches

DC-Switch Disconnect

Push Buttons

Representatives, Suppliers



## General

Approvals	4
Technical Information	5
Mounting Information	9
	10



## Micro Contactors

	11
Micro Contactors	12
Micro Contactor Relays	14
Micro Reversing Contactors	18
Technical Information	20
Dimensions	24



## Mini Contactors

	25
Mini Contactors	26
Interface Contactors	26
Mini Reversing Contactors	32
Technical Information	33
Dimensions	36



## Contactor Relays

	39
Contactor Relays	40
Technical Information	40
Dimensions	44



## Contactors

	45
Contactors Overview	46
Contactors, 3-pole	48
Contactors, 4-pole	50
Capacitor Switching Contactors	51
Accessories	52
Technical Information	62
Dimensions	82

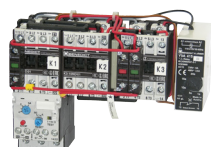

## Starters

	91
Star-Delta Starters	92
Reversing Contactors	96
Pole Changing Starters	98
Technical Information	100
Dimensions	107



## D.O.L. Starters

	111
D.O.L. Starters	112
Enclosures	113
Accessories	113
Technical Information	115
Dimensions	116



## Overload Relays

	119
Thermal Overload Relays	121
Accessories	123
Technical Information	125
Dimensions	129



## Modular Contactors

	133
Contactors	134
Accessories	135
Technical Information	138
Dimensions	140



## Contactors for DC-Switching Contactors RAST 5

	141
	145

## General

### Test Authorities, Registration Mark, Approvals

Low voltage switchgear from Benedict GmbH is built and tested to national and international specifications. All devices suit all important specifications without any test obligation, like VDE, BS and also relative to IEC Recommendations and to European Standards like IEC 947 and EN 60947. It is for this reason of our Low voltage switchgear is used all over the world. In order to provide special versions, limitations to the max. voltages, currents and power ratings or special markings are sometimes necessary.

### Quality Control System

Since November 1991 Benedict GmbH has been certified according to the quality control system **ÖNORM EN ISO 29001**. The target of the ISO-certification is, to grant the customer the quality of the performance of his supplier, who is audited in accordance with this standard.

### CE-Marking



The manufacturer has to sign his products with the CE-Marking. With the CE-Marking the manufacturer confirms the accordance with the different EEC Directives. The CE-Marking is absolutely necessary to sell the products in the EEC.

Below you find the EEC Directives concerning our products.

Low Voltage Directive 2006/95/EC

EMC Directive 2004/108/EC

RoHS + WEEE 2002/95/EC + "002/96/EC

Country	North America	Russia	China
State deputy or private examination (state admitted)	UL Canada, USA	EAC	CCC
Label marking of examination boards	Listed Component		
Duty of approvals	all switchgear	all switchgear	all switchgear

### Explanations for choice and supply of low voltage switchgear in Canada and USA

#### Marking of auxiliary contacts

At several devices in UL-data are two voltages for auxiliary contacts mentioned (e. g.: 600 volts at same potential, 150 volts at different potentials). That means, if the voltage is higher than 150 volts, the control voltage applied to input terminals must be at the same potential.

Low voltage switchgear for auxiliary circuits (e. g. contactor relays, control units, auxiliary contacts in general) usually approved for "Heavy Duty" or "Standard Duty" UL and besides these marked with the admissible max. voltage or with short codes (see table).

Marking of auxiliary contacts according to CSA and UL	Max. rated values per pole			Cont. Current A	Contact Rating Code Designation
	Voltage V	Current Make A	Break A		
Heavy Duty (HD or HVY DTY)	AC 120	60	6	10	A150
	AC 240	30	3	10	A300
	AC 480	15	1,5	10	A600
	AC 600	12	1,2	10	A600
	DC 125	2,2	2,2	10	N150
	DC 250	1,1	1,1	10	N300
	DC 600	0,4	0,4	10	N600
Standard Duty (SD or STD DTY)	AC 120	30	3	5	B150
	AC 240	15	1,5	5	B300
	AC 480	7,5	0,75	5	B600
	AC 600	6	0,6	5	B600
	DC 125	1,1	1,1	5	P150
	DC 250	0,55	0,55	5	P300
	DC 600	0,2	0,2	5	P600
-	AC 120	15	1,5	2,5	C150
	AC 240	7,5	0,75	2,5	C300
	AC 480	3,75	0,375	2,5	C600
	AC 600	3	0,3	2,5	C600
	DC 125	0,55	0,55	2,5	Q150
	DC 250	0,27	0,27	2,5	Q300
	DC 600	0,1	0,1	2,5	Q600
-	AC 120	3,6	0,6	1	D150
	AC 240	1,8	0,3	1	D300
	DC 125	0,22	0,22	1	R150
	DC 250	0,11	0,11	1	R300
-	AC 120	1,8	0,3	0,5	E150

#### Discernment at UL-Standards

##### Recognized Component Industrial Control Equipment

UL issues yellow "Guide cards" with Guide- and File-No.

Devices have permission to be marked with on the label



##### Listed Industrial Control Equipment

UL issues white "Guide cards" with Guide- and File-No.

Devices have to be marked with the "UL-Listing Mark"



Devices as components approved for "factory wiring": devices for employment in control panels, when they are selected, mounted and wired according to the charging conditions by skilled worker.

Devices approved for "field wiring",







- a) devices for employment in control panels, when they are mounted and wired by skilled worker.
- b) devices for retail in USA

Valid UL-Standards:  
UL 508 "Standard for Industrial Control Equipment" (partly limited)







Valid UL-Standards:  
UL 508 "Standard for Industrial Control Equipment" (unlimited)

Are devices approved as "Listed Equipment" the approval is also valid for using as "Recognized Component" .

# Approvals

Country	North America		Switzerland	Europe	Russia EAC	China	CENELEC CB-Certificates
Type	UL 		SEV 				
<b>Micro Contactor Relays, Micro Contactors K0, Micro Reversing Contactors and Accessories</b>							
K0-04D..	o	-	-	o	-	-	-
K0-05D..	o	-	-	o	-	o	-
K0W05D..	o	-	-	o	-	o	-
<b>Mini Contactor Relays, Mini Contactors, Mini Reversing Contactors K1 and Accessories</b>							
K1-07D..(=)	o	-	-	o	o	-	o
K1-07L..(=)	-	o	-	o	o	-	o
K1-07F..(=)	-	o	-	o	o	-	-
K1-09D..(=)	o	-	-	o	o	o	o
K1-09L..(=)	-	o	-	o	o	o	o
K1-09F..(=)	-	o	-	o	o	o	-
K1-12D..(=)	o	-	-	o	o	o	-
K1W09D01(=)	o	-	-	o	o	o	-
K1W12D01(=)	o	-	-	o	o	o	-
K1W09L01(=)	-	o	-	o	o	o	-
HK..., HKM..	o	-	-	o	o	-	o
RC-K1	o	-	-	o	o	-	-
<b>Contactor Relays, Contactors Series K3</b>							
K3-07ND..(=)	o	-	-	o	o	-	-
K3-10N..(=)	o	-	o	o	o	o	o
K3-14N..(=)	o	-	o	o	o	o	o
K3-18N..(=)	o	-	o	o	o	o	o
K3-22N..(=)	o	-	o	o	o	o	o
K3-24A..(=)	o	-	o	o	o	o	o
K3-32A..(=)	o	-	o	o	o	o	o
K3-40A..(=)	o	-	o	o	o	o	o
K3-50A..(=)	o	-	o	o	o	o	o
K3-62A..(=)	o	-	o	o	o	o	o
K3-74A..(=)	o	-	o	o	o	o	o
K3-90A..(=)	o	-	-	o	o	o	-
K3-115A..(=)	o	-	-	o	o	o	-
K3-151A..(=)	o	-	-	o	o	-	-
K3-176A..(=)	o	-	-	o	o	-	-
K3-210A..(=)	x	-	-	o	o	-	-
K3-260A..(=)	x	-	-	o	o	-	-
K3-316A..(=)	x	-	-	o	o	-	-
K3-450A..(=)	o	-	-	o	o	-	-
K3-550A..(=)	o	-	-	o	o	-	-
K3-700A..(=)	o	-	-	o	o	-	-
K3-860A..(=)	o	-	-	o	o	-	-
K3-1000A..(=)	-	-	-	o	o	-	-
K3-1200A..(=)	o	-	-	o	o	-	-
<b>Contactor Relays, Contactors DC operated Series KG3</b>							
KG3-07..	o	-	-	o	o	-	o
KG3-10..., -14..	o	-	-	o	o	-	o
KG3-18..., -22..	o	-	-	o	o	-	o
KG3-24..., -32..	o	-	-	o	o	-	o
KG3-40..	o	-	-	o	o	-	o
<b>Capacitor Contactors Series K3</b>							
K3-18K..	o	-	-	o	o	o	o
K3-24K..	o	-	-	o	o	o	o
K3-32K..	o	-	-	o	o	o	o
K3-50K..	o	-	-	o	o	o	o
K3-62K..	o	-	-	o	o	o	o
K3-74K..	o	-	-	o	o	o	o
K3-90K..	o	-	-	o	o	o	-
K3-115K..	o	-	-	o	o	o	-
<b>Aux. Contacts</b>							
HN..., HTN..	o	-	-	o	o	o	o
HA..	o	-	-	o	o	-	o
HB..	o	-	-	o	o	o	o
K2-DK, K2-SK	o	-	-	o	o	-	-
HKA..., HKT..	o	-	-	o	o	-	-
HKF22	-	-	-	o	o	-	-
o approved in standard version      x pending      - not provided to be tested							

# Approvals







Country	North America		Switzerland	Europe	Russia EAC	China	CENELEC CB-Certificates
Typ	UL		SEV				
							
<b>Accessories</b>							
K2-T.E, -A	-	-	-	o	o	-	-
K2-TP	o	-	-	o	o	-	-
K2-L	o	-	-	o	o	-	-
K2-IN.	o	-	-	o	o	-	-
K2-UN.	o	-	-	o	o	-	-
K2-IM	-	-	-	o	o	-	-
K2-E	o	-	-	o	o	-	-
VG-K2	-	-	-	o	o	-	-
RC-K3	o	-	-	o	o	-	-
<b>Reversing Contactors Series K3NWU</b>							
K3NWU-10	o	-	-	o	o	-	-
K3NWU-14	o	-	-	o	o	-	-
K3NWU-18	o	-	-	o	o	-	-
K3NWU-22	o	-	-	o	o	-	-
K3WU-24	o	-	-	o	o	-	-
K3WU-32	o	-	-	o	o	-	-
K3WU-40	o	-	-	o	o	-	-
<b>D.O.L Starters</b>							
P1..	o	-	-	o	o	-	-
<b>Thermal Overload Relays</b>							
U3/32	o	-	-	o	o	-	o
U3/42	o	-	-	o	o	-	o
U3/74	o	-	-	o	o	-	o
U12/16E	o	-	-	o	o	-	o
U12/16A	-	-	-	o	o	-	o
U12/16EM	-	-	-	o	o	-	o
U12/16EQ	-	-	-	o	o	-	o
U32	o	-	-	o	o	-	o
U60	o	-	-	o	o	-	o
U85	o	-	-	o	o	-	o
U180	x	-	-	o	o	-	-
U320	x	-	-	o	o	-	-
U800	-	-	-	o	o	-	-
<b>Modular Contactors</b>							
R20	o	-	o	o	o	-	o
R25	o	-	o	o	o	-	o
R40	o	-	o	o	o	-	o
R63	o	-	o	o	o	-	o
R40, R63 2-polig	-	-	-	o	o	-	o
RH11	o	-	-	o	o	-	o
<b>Push Buttons</b>							
B(C,K,S)3/4/5D	o	-	-	o	o	-	o
<b>Contactors Relays and Contactors Series K3 (RAST 5)</b>							
K3-10/14/18/22NR	o	-	-	o	o	o	o
<b>Contactors for DC-Loads</b>							
K3DC-20 bis 80	o	-	-	o	o	-	o
K3DC-100	-	-	-	o	o	-	o
K3PV-30 bis 60	-	-	-	o	o	-	o
K3PV-80	o	-	-	o	o	-	o
K3PV-100	-	-	-	o	o	-	o
K3PV-150 bis 450	o	-	-	o	o	-	o
<b>Main Contactors Series K3</b>							
K3-10/14/18/22NBD	-	-	-	o	o	-	o

o approved in standard version

x pending

- not provided to be tested

# Approvals

Country	North America		Switzerland	Europe	Russia EAC	China	CENELEC CB-Certificates
Typ	UL		SEV	CE	EAC	CCC	
							
<b>Motor Protection Circuit Breakers Series M4-..</b>							
M4-32T	o	-	-	o	o	-	-
M4-32R	o	-	-	o	o	-	-
M4-63R	o	-	-	o	o	-	-
M4-100R	o	-	-	o	o	-	-
<b>Zubehör</b>							
M4 HQ	o	-	-	o	o	-	-
M4 HS	o	-	-	o	o	-	-
M4 MA	o	-	-	o	o	-	-
M4 M	o	-	-	o	o	-	-
M4 U	o	-	-	o	o	-	-
M4 A	o	-	-	o	o	-	-
<b>Motor Protection Circuit Breakers Series MU25A-..</b>							
MU25A	o	-	-	o	-	-	-
<b>Accessories</b>							
MU25A-PS	o	-	-	o	-	-	-
MU25A-PV	o	-	-	o	-	-	-
MU25A-A	o	-	-	o	-	-	-
MU25A-U	o	-	-	o	-	-	-
<b>Mini DC-Isolators</b>							
LSM16/25	o	o	-	-	o	-	-
<b>DC-Switch Disconnectors, 2, 2+2, 4 pole</b>							
LS16/20/25/32	o	-	-	o	o	o	o
LS40/55	o	-	-	o	o	o	o
<b>DC-Switch Disconnectors, 3+2, 4+2, 6, 8 pole</b>							
LS16/20/25/32	o	o	-	o	o	o	-
LS40/55	o	o	-	o	o	o	-
<b>AC-Main Switches</b>							
LTS20/25/32/40	o	-	-	o	o	-	o
LTS63/80	o	-	-	o	o	-	o
LTS85/100/125	o	-	-	o	o	-	o
<b>AC-Cam Switches</b>							
M4H	o	-	-	o	o	-	o
M10	o	-	-	o	o	-	o
M10H(D)	o	-	-	o	o	-	o
M20	o	-	-	o	o	-	o
N33F	o	-	-	o	o	-	o
N40	o	-	-	o	o	-	o
N60	o	-	-	o	o	-	o
N61	o	-	-	o	o	-	o
N80	o	-	-	o	o	-	o
N100	o	-	-	o	o	-	o
N200	o	-	-	o	o	-	o
L400	o	-	-	o	o	-	o

o approved in standard version

x pending

- not provided to be tested

**cUL<sup>us</sup> - and cRU<sup>us</sup> - Guide- and File-No.**

These data are important for UL-inspectors.  
Devices

Devices	Guide-No.				File-No.
	cUL <sup>us</sup>		cRU <sup>us</sup>		
	Canada	USA	Canada	USA	
Contactors	NLDX7	NLDX	NLDX8	NLDX2	E41502
Revering Contactors	NLDX7	NLDX	-	-	E41502
Contactors Relays, Accessories	NKCR7	NKCR	NKCR8	NKCR2	E66273
Thermal Overload Relays	NKCR7	NKCR	-	-	E66273
Cam Switches	NLRV7	NLRV	-	-	E129916
Circuit Breakers as Manual Motor Controller	NLRV7	NLRV	-	-	E129916
Circuit Breakers as Combination Motor Controller	NKJH7	NKJH	-	-	E197641
Bus Bar Assemblies	NLRV7	NLRV	-	-	E129916
Accessories for Circuit Breakers	NKCR7	NKCR	-	-	E66273

## Technical Information

### Degree of protection acc. to IEC 60947-1

Protection ratings are prefixed by the internationally agreed letters IP followed by two digits.

1<sup>st</sup> digit: Pertains to solid objects  
2<sup>nd</sup> digit: Pertains to water.

1 <sup>st</sup> digit	Short description	Definition
1	Protected against solid objects greater than 50 mm	Excludes solid objects exceeding 50 mm in diameter and protects against contact with live and moving parts by a large body surface such as a hand (but not against deliberate access).
2L	Protected against solid objects greater than 12,5 mm and against contact by standard test finger	Excludes solid objects exceeding 12,5 mm in diameter and protects against contact with live and moving parts by a standard test finger or similar objects not exceeding 80 mm in length.
3	Protected against solid objects	Excludes solid objects exceeding 2,5 mm in diameter or thickness, greater than 2,5mm
4	Protected against solid objects greater than 1 mm	Excludes solid objects exceeding 1 mm in diameter or thickness.
5	Dust protected	Prevents ingress of dust in quantities and locations that would interfere with the intended operation of the equipment.
6	Dust tight	Prevents ingress of dust.

### Terminal markings acc. to EN50011

Auxiliary contacts of AC contactors and contacts of contactor relays and thermal overload relays are particularly marked. The terminal markings of normally-open contacts are printed as positive figures, they of normally-closed contacts as negative figures.

This gives a clear indication of the function of the contacts.

The figure below illustrates the determination of terminal markings for contactors with auxiliary contact blocks.

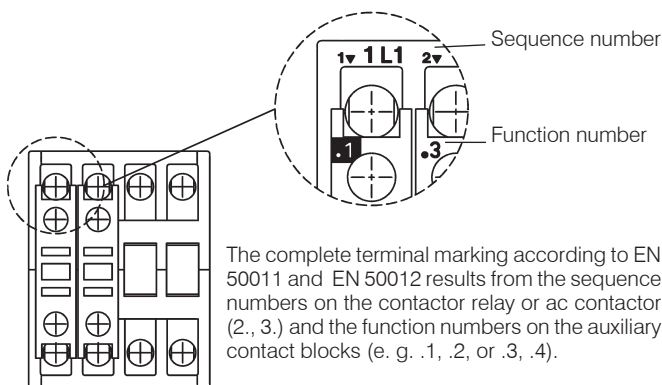

2 <sup>nd</sup> digit	Short description	Definition
1	Protected against dripping water	Dripping water (vertically falling drops) shall have no harmful effect.
2	Protected against dripping water when tilted up to 15°	Vertically dripping water shall have no harmful effect when the enclosure is tilted at any angle up to 15° from its normal position.
3	Protected against spraying water	Water falling as a spray at an angle up to 60° from the vertical shall have no harmful effect.
4	Protected against splashing water	Water splashed against the enclosure from any direction shall have no harmful effect.
5	Protected against water jets	Water protected by a nozzle against the enclosure from any direction shall have no harmful effect.
6	Protected against heavy seas	Water from heavy seas or water projected in powerful jets shall not enter the enclosure in harmful quantities.
7	Protected against the effects of immersion	Ingress of water in a harmful quantity shall not be possible when the enclosure is immersed in water under standard conditions of pressure and time.
8	Protected against submersion	No ingress of water.

### Resistance to climatic conditions acc. to IEC60068

Open-type devices are climate-resistant in the constant climate according to IEC60068-2-78 (this is a climate with an ambient temperature of 40°C and an atmospheric humidity of 90 to 95%).

Enclosed devices are climate-resistant in an alternating climate according to IEC 68-2-30 (this is a moist alternating climate with a 24-hour cycle between climates with an ambient temperature of 25°C, and an atmospheric humidity of 95 to 100% and an ambient temperature of 40°C, and an atmospheric humidity of 90 to 96% in the presence of condensation during rises in temperature).

Data are valid up to an altitude of 2000m above sea level.

### Short circuit protection

Back up fuses should be used to protect contactors and starters against short circuits. For starters the device with the smaller admissible fuse at the main and at the control circuit (contactor or thermal overload) determines the fuse size.

After a short circuit devices have to be checked for correct operation. Disconnect power before proceeding with any work on the equipment!



# Technical Information

## Mounting positions of contactors

K0-.. / K1-..

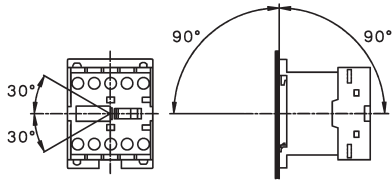

K2-..A00-40, K(G)3-07 to K3-115, R..

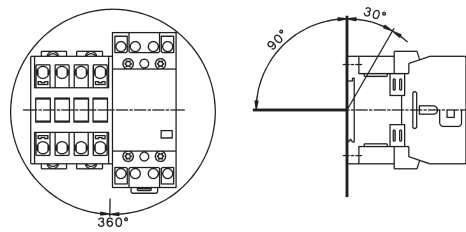



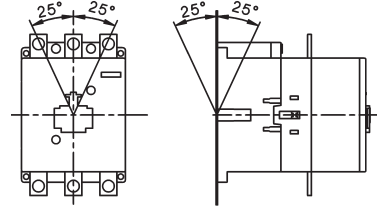



K3-151.. to K3-1200..



## Terminal screws

Devices Type	Kind of connection			Screw driver	Tightening torque	
	Screw with washer	Screw with clamp box	Screw w. nut		Nm	lb. inch
<b>Micro Contactors</b> , all conductors K0-..	M2,5	-	-	Pz1	0,6 - 0,8	5 - 7
<b>Mini Contactors</b> , all conductors K1-..	M3,5	-	-	Pz2	0,8 - 1,4	7 - 12
<b>Contactors Relays</b> , all conductors K(G)3-07..	M3,5	-	-	Pz2	0,8 - 1,4	7 - 12
<b>Contactors</b> Main conductor						
K(G)3-10.. bis K3-22..	M3,5	-	-	Pz2	0,8 - 1,4	7 - 12
K(G)3-24.. bis K3-40..	-	M5	-	Pz2	2,5 - 3	22 - 26
K3-50.. bis K3-74..	-	M6	-	Pz3	3,5 - 4,5	31 - 40
K2-23, -30, -37A00-40 K2-45, -60A00-40	M4 -	- M6	- -	Pz2 Pz3	1,2 - 1,8 3,5 - 4,5	11 - 16 31 - 40
K3-90, K3-115	-	-	M8	4mm hex socket	4 - 6,5	35 - 57
K3-116.. bis K3-176.. K3-210.. bis K3-316.. K3-450.. bis K3-700.. K3-860.. K3-1000.., K3-1200..	- - - - -	- - - - -	M8 M10 M12 M14 M12		17 35 60 75 60	150 315 540 675 540
Auxiliary conductor K(G)3-10 bis K3-22	M3,5	-	-	Pz2	0,8 - 1,4	7 - 12
Coil conductor K(G)3-10 bis K3-1200	M3,5	-	-	Pz2	0,8 - 1,4	7 - 12
<b>Accessories</b> HK, HKM HA, HN, K2-..., HB..	M3,5 M3,5	- -	- -	Pz2 Pz2	0,8 - 1,4 0,8 - 1,4	7 - 12 7 - 12
<b>Thermal Overload Relays</b> Main conductor						
U12/16	M4	-	-	Pz2	1,2 - 1,8	11 - 16
U3/32 U3/42 U3/74	M3,5 M5 -	- - M6	- - -	Pz2 Pz2 Pz3	0,8 - 1,4 2,5 - 3 3,5 - 4,5	7 - 12 22 - 26 31 - 40
UAT21 UAT22 UAT23	- - -	M4 M4 M5	- - -	Size 3, 4 Size 3, 4 Size 3, 4, 5	1,2 - 1,8 1,2 - 1,8 2,5 - 3	11 - 16 11 - 16 22 - 26
Auxiliary conductor All devices	M3,5	-	-	Pz2	0,8 - 1,4	7 - 12
<b>Contactors for Distribution Boards</b> Conductors						
R20, R25 R40, R63 K1R	- - M3,5	M3,5 M5 -	- - -	Pz1 Pz2 Pz2	0,8 - 1,4 2,5 - 3 0,8 - 1,4	7 - 12 22 - 26 7 - 12
Coil conductor R20, R25 R40, R63 K1R RH11	- - M3,5 -	M3 M3 - M3	- - - -	Pz1 Pz1 Pz2 Pz1	0,6 - 1,2 0,6 - 1,2 0,8 - 1,4 0,6 - 1,2	5 - 11 5 - 11 7 - 12 5 - 11

	<p>Micro Contactor Relays</p>	<p>12</p>
	<p>Micro Contactors</p>	<p>14</p>
	<p>Micro Contactors With Solder Pins</p> <p>Coil voltages</p>	<p>16</p> <p>16</p>
	<p>Micro Reversing Contactor</p>	<p>18</p>
	<p>Technical Data</p>	<p>20</p>
	<p>Dimensions</p>	<p>24</p>

# Micro Contactor Relays 4-pole

AC Operated

**Ratings Therm.**      **Contacts 2)**      **Type**      **Coil voltage 1)**  
 Distinc.      Additional      **24**      24V 50/60Hz  
 Number      Contact      **230**      220-240V 50Hz/60Hz

**AC15**      Rated Current       **230V**      400V      I<sub>th</sub>      acc. to      Blocks      ↓      Pack      Weight  
**A**      A      A      NO      NC      EN50011      Type      pcs.      kg/pc.

## 4-pole, with Screw Terminals



Type	3	1,5	5	4	-	40E	-	K0-04D40 ...	10	0,07
	3	1,5	5	3	1	31E	-	K0-04D31 ...	10	0,07
	3	1,5	5	2	2	22E	-	K0-04D22 ...	10	0,07

**K0-04D40**

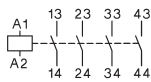

**K0-04D31**

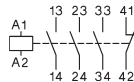

**K0-04D22**

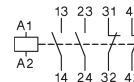

1) Other coil voltages on request.  
 2) Contacts suitable for electronic circuits, according to EN947-5-4 for rated voltage 24V DC (test ratings 17V DC, 5mA). Mirror contacts acc. IEC60947-4-1 Annex F.

# Micro Contactor Relays 4-pole

DC Operated

Ratings Therm.	Contacts <sup>2)</sup>	Distinc. Number	Additional Contact	Type	Coil voltage <sup>1)</sup>	Pack pcs.	Weight kg/pc.
<b>AC15</b>	Rated Current				<b>= 24</b>		
<b>230V</b> <b>A</b>	400V A	$I_{th}$ A	NO NC	acc. to EN50011	Blocks Type		



## 4-pole, with Screw Terminals

<b>3</b>	1,5	5	4	-	40E	-	<b>K0-04D40= ...</b>	10	0,09
<b>3</b>	1,5	5	3	1	31E	-	<b>K0-04D31= ...</b>	10	0,09
<b>3</b>	1,5	5	2	2	22E	-	<b>K0-04D22= ...</b>	10	0,09

**K0-04D40**

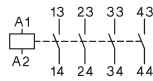

**K0-04D31**

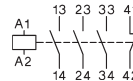

**K0-04D22**

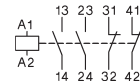

1) Other coil voltages on request.

2) Contacts suitable for electronic circuits, according to EN947-5-4 for rated voltage 24V DC (test ratings 17V DC, 5mA). Mirror contacts acc. IEC60947-4-1 Annex F.

# Micro Contactors

# AC Operated

Power Ratings	Rated Current	Aux. Contacts <sup>2)</sup>		Type	Coil voltage <sup>1)</sup>	Pack pcs.	Weight kg/pc.
		Built-in	Additional				
AC2, AC3 <b>380V</b> <b>400V</b> <b>415V</b> <b>kW</b>	660V 690V A	AC1	NO NC	<b>24</b> <b>230</b>	24V 50/60Hz 220-240V 50Hz/60Hz		
				↓			



### 3-pole, with Screw Terminals

2,2	-	12	1	-	-	<b>K0-05D10 ...</b>	10	0,07
-----	---	----	---	---	---	---------------------	----	------

2,2	-	12	-	1	-	<b>K0-05D01 ...</b>	10	0,07
-----	---	----	---	---	---	---------------------	----	------

### 4-pole, With Screw Terminals

2,2	-	12	-	-	-	<b>K0-05D00-40 ...</b>	10	0,07
-----	---	----	---	---	---	------------------------	----	------

**K0-05D10**

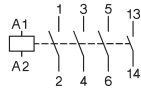

**K0-05D01**

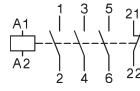

**K0-05D00-40**

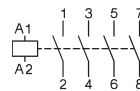

1) Other coil voltages see page 14.

2) Contacts suitable for electronic circuits, according to EN947-5-4 for rated voltage 24V DC (test ratings 17V DC, 5mA). Mirror contacts acc. IEC60947-4-1 Annex F.

# Micro Contactors

DC Operated



Power Ratings	Rated Current	Aux. Contacts <sup>2)</sup>		Type	Coil voltage <sup>1)</sup> = 24 24V= DC	Pack pcs.	Weight kg/pc.
		Built-in	Additional				
AC2, AC3	AC1						
<b>380V</b>							
<b>400V</b>	660V						
<b>415V</b>	690V	440V					
<b>kW</b>	<b>kW</b>	<b>A</b>	NO NC	Blocks Type			

## 3-pole, with Screw Terminals

2,2	-	12	1	-	-	<b>K0-05D10= ...</b>	10	0,09
-----	---	----	---	---	---	----------------------	----	------

2,2	-	12	-	1	-	<b>K0-05D01= ...</b>	10	0,09
-----	---	----	---	---	---	----------------------	----	------

## 4-pole, With Screw Terminals

2,2	-	12	-	-	-	<b>K0-05D00-40= ...</b>	10	0,09
-----	---	----	---	---	---	-------------------------	----	------

**K0-05D10**

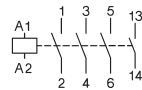

**K0-05D01**

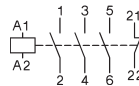

**K0-05D00-40**

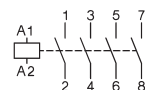

# Snap-On Adapter

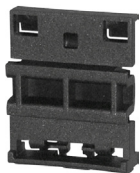

For Type	Specification	Type	Pack pcs..	Weight kg/pc.
K0	Snap on Adapter for K0	P1039	10	0,0061

for snap-on mounting of contactor K0 on 35mm DIN-rail acc. DIN EN 50022

1) Other coil voltages see page 14.  
 2) Contacts suitable for electronic circuits, according to EN947-5-4 for rated voltage 24V DC (test ratings 17V DC, 5mA). Mirror contacts acc. IEC60947-4-1 Annex F.

# Micro Contactors

# AC Operated

Power Ratings	Rated Current	Aux. Contacts <sup>2)</sup>		Type	Coil voltage <sup>1)</sup>	Pack pcs.	Weight kg/pc.
		Built in	Additional				
AC2, AC3	AC1				24V 50/60Hz		
<b>380V</b>					220-240V 50Hz/60Hz		
<b>400V</b>	660V						
<b>415V</b>	690V	440V					
<b>kW</b>	<b>kW</b>	<b>A</b>	NO NC	Type			



### 3-pole, with Solder Pins Ø1,15 for Printed Circuit Applications

2,2	-	9	1	-	-	<b>K0-05L10</b> ...	10	0,07
-----	---	---	---	---	---	---------------------	----	------

2,2	-	9	-	1	-	<b>K0-05L01</b> ...	10	0,07
-----	---	---	---	---	---	---------------------	----	------

### 4-pole, with Solder Pins Ø1,15 for Printed Circuit Applications

2,2	-	9	-	-	-	<b>K0-05L00-40</b> ...	10	0,07
-----	---	---	---	---	---	------------------------	----	------

**K0-05L10**

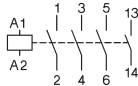

**K0-05L01**

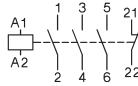

**K0-05L00-40**

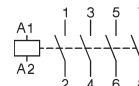

## Coil voltages for AC operated contactors

Suffix to contactor type e.g. K0-05D10 24	Voltage Marking at the coil for		Rated Control Voltage U <sub>s</sub> range for 50Hz for 60Hz			
	50Hz	60Hz	min.	max.	min.	max.
12	12	12	11	12	12	12
<b>24</b>	<b>24</b>	<b>24</b>	<b>22</b>	<b>24</b>	<b>24</b>	<b>24</b>
42	42	42	38,5	42	42	42
48	48	48	48	50	48	52
90	100	100	90	100	100	105
95	95-100	105-110	95	100	105	110
100	100	110-115	100	105	110	115
105	105-110	115-120	105	110	115	120
110	110-115	120-125	110	115	120	125
180	200	200	185	200	200	210

Suffix to contactor type e.g. K0-05D10 230	Voltage Marking at the coil for		Rated Control Voltage U <sub>s</sub> range for 50Hz for 60Hz			
	50Hz	60Hz	min.	max.	min.	max.
200	200	200-220	195	205	200	220
210	205-215	220-230	205	215	220	230
220	210-220	220-240	210	220	220	240
<b>230</b>	<b>220-230</b>	<b>230-250</b>	<b>220</b>	<b>230</b>	<b>230</b>	<b>250</b>
240	230-240		230	240	250	260

**Standard voltages in bold type letters**  
**Operating range of magnet-coils: 0,85 x U<sub>s</sub>**  
**(min. value of rated control voltage)**  
**up to 1,1 x U<sub>s</sub>**  
**(max. value of rated control voltage)**

Coil not exchangeable

1) Other coil voltages see page 14.

2) Contacts suitable for electronic circuits, according to EN947-5-4 for rated voltage 24V DC (test ratings 17V DC, 5mA). Mirror contacts acc. IEC60947-4-1 Annex F.

# Micro Contactors

DC Operated

Power Ratings	Rated Current	Aux. Contacts <sup>2)</sup>		Type	Coil voltage <sup>1)</sup> = 24 24V= DC	Pack pcs.	Weight kg/pc.
		Built in	Additional				
AC2, AC3 <b>380V</b> <b>400V</b> <b>415V</b> <b>kW</b>	660V 690V kW	AC1 440V A					
			NO NC	Type	↓		



### 3-pole, with Solder Pins Ø1,15 for Printed Circuit Applications

2,2	-	9	1	-	-	<b>K0-05L10 ...</b>	10	0,07
-----	---	---	---	---	---	---------------------	----	------

2,2	-	9	-	1	-	<b>K0-05L01 ...</b>	10	0,07
-----	---	---	---	---	---	---------------------	----	------

### 4-pole, with Solder Pins Ø1,15 for Printed Circuit Applications

2,2	-	9	-	-	-	<b>K0-05L00-40 ...</b>	10	0,07
-----	---	---	---	---	---	------------------------	----	------

**K0-05L10**

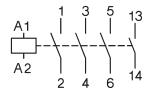

**K0-05L01**

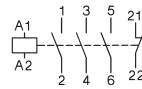

**K0-05L00-40**

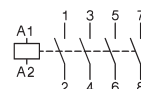



1) Other coil voltages see page 14.  
 2) Contacts suitable for electronic circuits, according to EN947-5-4 for rated voltage 24V DC (test ratings 17V DC, 5mA). Mirror contacts acc. IEC60947-4-1 Annex F.



# Micro Reversing Contactors, Mechanical Interlocked

AC Operated

Power Ratings	Rated Current	Aux. Contacts <sup>2)</sup>		Type	Coil voltage <sup>1)</sup> 24V 50/60Hz 220-240V 50Hz/60Hz	Pack pcs.	Weight kg/pc.
		Built-in	Additional on left hand side Contactor				
AC2, AC3	AC1						
<b>380V</b>							
<b>400V</b>	660V						
<b>415V</b>	690V	440V		K1 Type			
<b>kW</b>	<b>kW</b>	<b>A</b>		K2 Type			

## 3-pole, with Screw Terminals



2,2	-	12	-	2	-	-	<b>K0W05D01MC ...</b>	1	0,14
-----	---	----	---	---	---	---	-----------------------	---	------

2,2	-	12	2	-	-	-	<b>K0W05D10MC ...</b>	1	0,14
-----	---	----	---	---	---	---	-----------------------	---	------

## 4-pole, with Screw Terminals



2,2	-	12	-	-	-	-	<b>K0W05D00-40MC ...</b>	1	0,14
-----	---	----	---	---	---	---	--------------------------	---	------

## 3-pole, with Solder Pins Ø1,15 for Printed Circuit Applications

2,2	-	xxx <sup>3)</sup>	-	2	-	-	<b>K0W05L01MC ...</b>	1	0,14
-----	---	-------------------	---	---	---	---	-----------------------	---	------

2,2	-	xxx <sup>3)</sup>	2	-	-	-	<b>K0W05L10MC ...</b>	1	0,14
-----	---	-------------------	---	---	---	---	-----------------------	---	------

**K0W05D01MC**

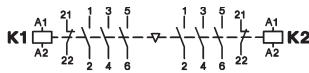

**K0W05D10MC**

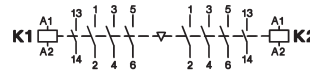

**K0W05D00-40MC**

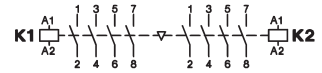

# Reversing Starter Connector



For Reversing Starter Types, incl. Coil Connector

Type	Pack pcs.	Weight kg/pc.
<b>K0W05D..MC</b>	<b>K0W-VB</b>	1 0,01

1) Other coil voltages see page 14.

2) Contacts suitable for electronic circuits, according to EN947-5-4 for rated voltage 24V DC (test ratings 17V DC, 5mA). Mirror contacts acc. IEC60947-4-1 Annex F.

3) Data on request.

# Micro Reversing Contactors, Mechanical Interlocked

DC Operated

Power Ratings	Rated Current	Aux. Contacts <sup>2)</sup>		Type	Coil voltage <sup>1)</sup> = 24 24V= DC	Pack pcs.	Weight kg/pc.
		Built-in	Additional				
AC2, AC3	AC1		on left hand side Contactor	on right hand side Contactor			
<b>380V</b>							
<b>400V</b>	660V						
<b>415V</b>	690V	440V					
<b>kW</b>	<b>kW</b>	<b>A</b>	NO NC	K1 Type	K2 Type		

## 3-pole, with Screw Terminals



2,2	-	12	-	2	-	-	<b>K0W05D01MC ...</b>	1	0,14
-----	---	----	---	---	---	---	-----------------------	---	------

2,2	-	12	2	-	-	-	<b>K0W05D10MC ...</b>	1	0,14
-----	---	----	---	---	---	---	-----------------------	---	------

## 4-pole, with Screw Terminals



2,2	-	12	-	-	-	-	<b>K0W05D00-40MC ...</b>	1	0,14
-----	---	----	---	---	---	---	--------------------------	---	------

## 3-pole, with Solder Pins Ø1,15 for Printed Circuit Applications

2,2	-	xxx <sup>3)</sup>	-	2	-	-	<b>K0W05L01MC ...</b>	1	0,14
-----	---	-------------------	---	---	---	---	-----------------------	---	------

2,2	-	xxx <sup>3)</sup>	2	-	-	-	<b>K0W05L10MC ...</b>	1	0,14
-----	---	-------------------	---	---	---	---	-----------------------	---	------

**K0W05D01MC**

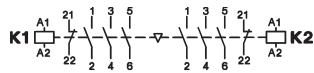

**K0W05D10MC**

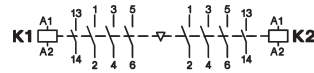

**K0W05D00-40MC**

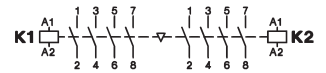

1) Other coil voltages see page 14.  
 2) Contacts suitable for electronic circuits, according to EN947-5-4 for rated voltage 24V DC (test ratings 17V DC, 5mA). Mirror contacts acc. IEC60947-4-1 Annex F.  
 3) Data on request.

# Micro Contactors

## Data according to IEC 60947-4-1, VDE 0660, EN 60947-4-1

Main Contacts	Type	K0-05D..	K0-05L..
<b>Rated insulation voltage <math>U_i</math></b>	V AC	440 <sup>1)</sup>	440 <sup>1)</sup>
<b>Making capacity <math>I_{eff}</math></b> at $U_e = 440V$ AC	A	65	65
<b>Breaking capacity <math>I_{eff}</math></b> $\cos\phi = 0,65$ 400V AC	A	50	50
<b>Utilization category AC1</b>			
<b>Switching of resistive load</b>			
Rated operational current $I_e (=I_{th})$ at 40°C, open	<b>A</b>	<b>12</b>	<b>9</b>
Rated operational power of three-phase resistive loads 50-60Hz, $\cos\phi = 1$	230V kW 240V kW 400V kW 415V kW 440V kW	4,7 4,8 8,3 8,6 9,0	3,5 3,7 3,3 6,4 6,8
Rated operational current $I_e (=I_{th})$ at 60°C, enclosed	A	8	6
Rated operational power of three-phase resistive loads 50-60Hz, $\cos\phi = 1$	230V kW 240V kW 400V kW 415V kW 440V kW	3,1 3,3 5,5 5,7 6,0	2,3 2,4 4,1 4,3 4,5
Minimum cross-section of conductor at load with $I_e (=I_{th})$	mm <sup>2</sup>	1,5	-
<b>Utilization category AC2 and AC3</b>			
<b>Switching of three-phase motors</b>			
Rated operational current $I_e$ open and enclosed	220V A 230V A 240V A	6,2 6,2 5,6	6,2 6,2 5,6
	<b>380-400V A</b> 415-440V A	<b>5</b> 5	<b>5</b> 5
Rated operational power of three-phase motors 50-60Hz	220-240V kW <b>380-440V kW</b>	1,5 <b>2,2</b>	1,5 2,2
<b>Utilization category AC4</b>			
<b>Switching of squirrel cage motors, inching</b>			
Rated operational current $I_e$ open and enclosed	220V A 230V A 240V A	4,9 4,9 4,1	4,9 4,9 4,1
	<b>380-400V A</b> 415-440V A	<b>3,5</b> 3,5	<b>3,5</b> 3,5
Rated operational power of three-phase motors 50-60Hz	220-240V kW <b>380-440V kW</b>	1,1 <b>1,5</b>	1,1 1,5
<b>Utilization category AC5a</b>			
<b>Switching of gas discharge lamps</b>			
Rated operational current $I_e$ per pole at 220/230V			
Fluorescent lamps, uncompensated and serial compensated	A	6	6
parallel compensated dual-connection	A A	0,5 9	0,5 9
Metal halide lamps <sup>2)</sup> , uncompensated	A	6	6
parallel compensated	A	0,5	0,5
Mercury-vapour lamps <sup>3)</sup> , uncompensated	A	9	9
parallel compensated	A	0,5	0,5
Mixed light lamps <sup>4)</sup>	A	9	9
<b>LED-Lamps</b>			
consider the inrush current of the lamp ballast and $\cos\phi$ of the lamp	max. lamps per pole ( $I_{nLED} \leq I_{th}$ ) =	$\frac{\text{inrush current of contactor}}{\text{inrush current of lamp/EVG}}$	
max inrush current of contactor	A	91	91
<b>Utilization category AC5b</b>			
<b>Switching of incandescent lamps<sup>5)</sup></b>			
Rated operational current $I_e$ per pole at 220/230V	A	3	3

1) Suitable for: earthed-neutral systems, overvoltage category I to III, pollution degree 3 (standard-industry):  $U_{imp} = 4kV$ .  
Data for other conditions on request.

2) Metal halide lamps and sodium-vapour lamps (high- and low-pressure lamps)

3) High-pressure lamps

4) Blended lamps, containing a mercury high-pressure unit and a tungsten helix in a fluorescent glass bulb (daylight lamps)

5) Current inrush approx. 16 x  $I_e$

# Micro Contactors

## Data according to IEC 60947-4-1, VDE 0660, EN 60947-4-1

Main Contacts			Type	K0-05D..	K0-05L..
<b>Utilization category DC1</b>					
<b>Switching of resistive load</b>	1 pole	24V	A	12	9
Time constant L/R ≤1ms		60V	A	12	9
Rated operational current I <sub>e</sub>		110V	A	2	2
		180V	A	0,6	0,6
		220V	A	0,4	0,4
	3 poles in series	24V	A	12	9
		60V	A	12	9
		110V	A	12	9
		180V	A	12	9
		220V	A	8	8
<b>Utilization category DC3 and DC5</b>					
<b>Switching of shunt motors and series motors</b>	1 pole	24V	A	12	9
Time constant L/R ≤15ms		60V	A	-	-
Rated operational current I <sub>e</sub>		110V	A	-	-
		220V	A	-	-
	3 Pole in Serie	24V	A	12	9
		60V	A	12	9
		110V	A	6	6
		180V	A	4	4
		220V	A	1	1
<b>Maximum ambient temperature</b>					
Operation with thermal overload relay	open	°C		-40 to +60 (+90) <sup>1)</sup>	
	enclosed	°C		-40 to +40	
	open	°C		-25 to +60	
	enclosed	°C		-25 to +40	
Storage		°C		-50 to +90	
<b>Short circuit protection</b>					
for contactors without thermal overload relay					
Coordination-type "1" according to IEC 947-4-1					
Contact welding without hazard of persons max. fuse size	gL (gG)	A		32	32
Coordination-type "2" according to IEC 947-4-1					
Light contact welding accepted max. fuse size	gL (gG)	A		-	-
Contact welding not accepted max. fuse size	gL (gG)	A		-	-
For contactors with thermal overload relay the device with the smaller admissible backup fuse (contactor or thermal overload relay) determines the fuse size.					
<b>Cable cross-sections</b>					
for contactors					
main connector	solid or stranded	mm <sup>2</sup>		0,5 - 1,5	Solder Connector
	flexible	mm <sup>2</sup>		0,5 - 1,5	Ø 1,15
	flexible with multicore cable end	mm <sup>2</sup>		0,5 - 1,5	
Cables per clamp				2	-
	solid or stranded	AWG		20 - 14	
<b>Frequency of operation z</b>					
contactors without thermal overload relay					
	without load	1/h		10000	10000
	AC3, I <sub>e</sub>	1/h		600	600
	AC4, I <sub>e</sub>	1/h		120	120
	DC3, I <sub>e</sub>	1/h		600	600
<b>Mechanical life</b>					
	AC operated	S x10 <sup>6</sup>		3	3
	DC operated	S x10 <sup>6</sup>		4	4
<b>Short time current</b>					
	10s-current	A		50	50
<b>Power loss per pole</b>					
	at I <sub>e</sub> /AC3 400V	W		0,2	0,2
<b>Resistance to shock according to IEC 68-2-27</b>					
Shock time 20ms sine-wave					
AC operated	NO	g		2,5	2,5
	NC	g		2,5	2,5

1) With reduced control voltage range 0,9 up to 1,0 x U<sub>s</sub> and with reduced rated current I<sub>e</sub>/AC1 according to I<sub>e</sub>/AC3.

# Micro Contactors

## Data according to IEC 60947-5-1, VDE 0660, EN 60947-5-1

Auxiliary Contacts			Type	K0-04D.. K0-05D..	K0-04L.. K0-05L..
<b>Rated insulation voltage</b>	<b>U<sub>i</sub></b>	VAC		440 <sup>1)</sup>	440 <sup>1)</sup>
<b>Thermal rated current I<sub>th</sub></b> to 440V					
Ambient temperature	40°C	A		5	5
	60°C	A		3	3
<b>Verlustleistung</b> pro Pol	bei I <sub>th</sub>	W		0,25	0,25
<b>Utilization category AC15</b>					
Rated operational current I <sub>e</sub>	220-240V	A		3	3
	380-415V	A		1,5	1,5
	440V	A		1	1
<b>Utilization category DC13</b>					
Rated operational current I <sub>e</sub>	24V	A		2	2
	60V	A		1,6	1,6
	110V	A		0,3	0,3
	180V	A		0,2	0,2
	220V	A		0,05	0,05
<b>Maximum ambient temperature</b>					
Operation	open	°C		-40 to +60 (+90) <sup>2)</sup>	
	enclosed	°C		-40 to +40	
Storage		°C		-40 to +90	
<b>Short circuit protection</b>					
short-circuit current 1kA, contact welding not accepted max. fuse size			gL (gG) A	10	10
For contactors with thermal overload relay the device with the smaller admissible control fuse (contactor or thermal overload relay) determines the fuse size.					
<b>Power consumption of coils</b>					
AC operated	inrush	VA		9	9
	sealed	VA		4	4
		W		1,8	1,8
DC operated	inrush	W		2,5	2,5
	sealed	W		2,5	2,5
<b>Operation range of coils</b>					
in multiples of control voltage U <sub>s</sub>		AC		0,85 - 1,1	0,85 - 1,1
		DC		0,8 - 1,1	0,8 - 1,1
<b>Switching time</b> at control voltage U <sub>s</sub> ±10% <sup>3) 4)</sup>					
AC operated	make time	ms		13 - 18	13 - 18
	release time	ms		5 - 10	5 - 10
	arc duration	ms		10 - 15	10 - 15
DC operated	make time	ms		10 - 40	10 - 40
	release time	ms		2 - 10	2 - 10
	arc duration	ms		10 - 15	10 - 15
<b>Cablecross-section</b>					
all connectors	solid	mm <sup>2</sup>		0,5 - 1,5	Solder Connector
	flexible	mm <sup>2</sup>		0,5 - 1,5	Ø 1,15
	flexible with multicore cable end	mm <sup>2</sup>		0,5 - 1,5	
Clamps per pole				2	-
	solid or stranded	AWG		20 - 14	-

1) Suitable at 690V for: earthed-neutral systems, overvoltage category I to III, pollution degree 3 (standard-industry); U<sub>imp</sub> = 4kV.  
Data for other conditions on request.

2) With reduced control voltage range 0,9 up to 1,0 x U<sub>s</sub> and with reduced thermal rated current I<sub>th</sub> to I<sub>e</sub>/AC15.

3) Summary switching time = release time + arc duration.

4) Release time of NC make time of NO increase when suppressor units for voltage peak protection are used (Varistor, RC-units, Diode units).

5) Data on request.

# Micro Contactors for North America

## Data according to UL508

Main Contacts (cULus)		Type	K0-05D.. K0W05D01..	K0-04D..	K0-05L..	K0-04L..
Rated operational current "General Use"		A	12	5	9	5
Rated operational power of three motors at 60Hz (3ph)	110-120V	hp	1/2	-	1/2	-
	200-208V	hp	1	-	1	-
	220-240V	hp	1	-	1	-
	277V	hp	1 1/2	-	1 1/2	-
Rated operational power of AC motors at 60Hz (1ph)	110-120V	hp	1/6	-	1/6	-
	200-208V	hp	1/2	-	1/2	-
	220-240V	hp	3/4	-	3/4	-
Fuse / Short-circuit current		A/kA	30/5	-	30/5	-
Rated voltage		VAC	480	480	480	480
<b>Auxiliary Contacts (cULus)</b>						
	heavy pilot duty	AC	B300	B300	B300	B300
	standard pilot duty	DC	R300	R300	R300	R300

### Motor Rating P<sub>n</sub> = AC4

440/ 380/ 220/  
460V 400V 230V  
kW kW kW

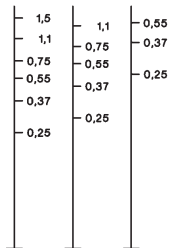

### Motor Rating P<sub>n</sub> = AC3

440/ 380/ 220/  
460V 400V 230V  
kW kW kW

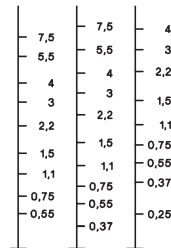

### Breaking Current I<sub>a</sub> (= I<sub>e</sub> = AC1) A

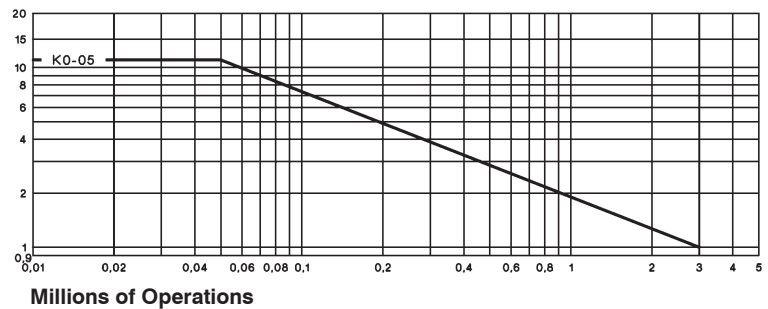

# Micro Contactors

## Dimensions

AC or DC operated  
with screw terminals

K0-04D.. (=)  
K0-05D.. (=)

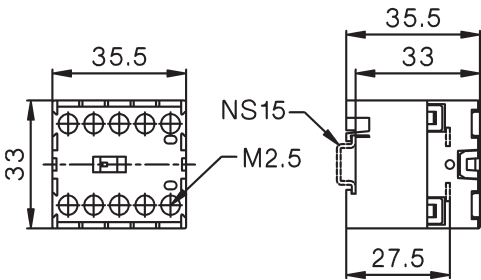

Snap-On Adapter P1039

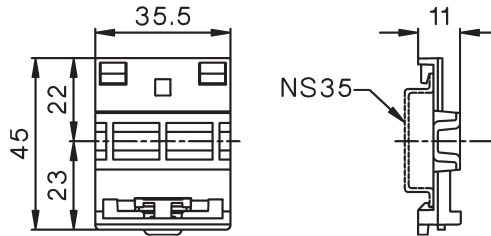

Reversing Contactors  
with screw terminals

K0W05D..MC

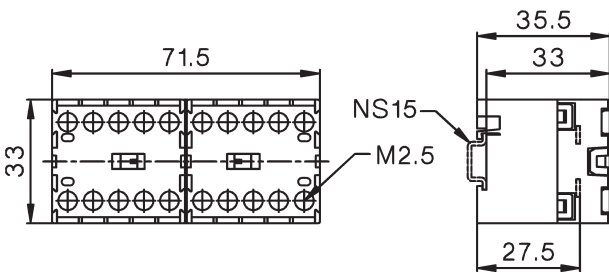

K0-..D.. with Snap-On Adapter P1039

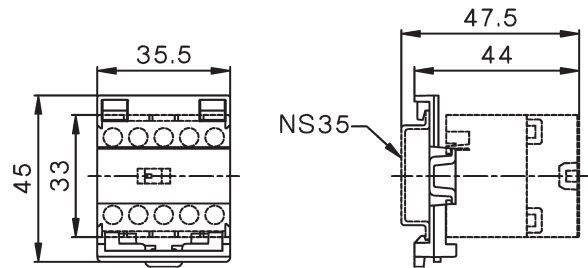

AC or DC operated  
with solder connections



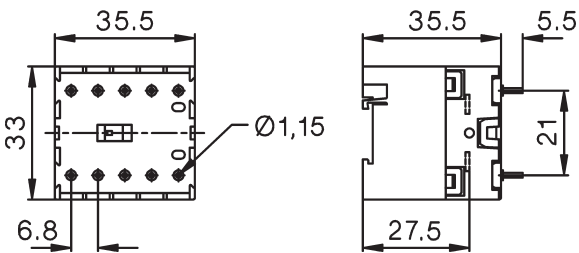



K0-04L.. (=)  
K0-05L.. (=)

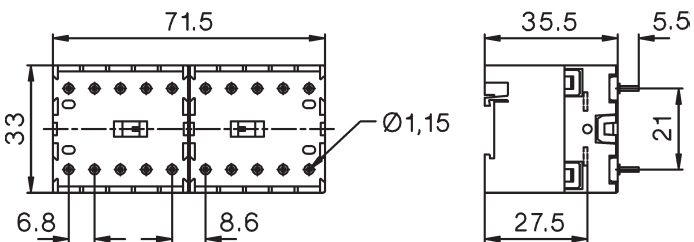

Reversing Contactors  
with solder connections

K0W05L..MC

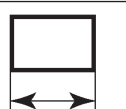

	<p>Mini Contactor Relays 4-pole Auxiliary Contact Blocks</p>	<p>26</p>
	<p>Interface Contactor Relays</p>	<p>27</p>
	<p>Mini Contactors Auxiliary Contact Blocks</p>	<p>28</p>
	<p>Mini Contactors With Fast On Tab Connectors</p>	<p>30</p>
	<p>Mini Contactors With Solder Pins</p>	<p>30</p>
	<p>Coil voltages</p>	<p>30</p>
	<p>Mini Reversing Contactors Auxiliary Contact Blocks</p>	<p>32</p>
	<p>Technical Data</p>	<p>33</p>
	<p>Dimensions</p>	<p>38</p>



# Mini Contactor Relays 4-pole

AC Operated

Ratings	Therm. Distinc. Number	Contacts <sup>2)</sup> Additional Contact	Type	Coil voltage <sup>1)</sup>
<b>AC15</b>				24V 50/60Hz
<b>230V</b>				220-230V 50Hz
<b>A</b>				24V 50/60Hz w. protection <sup>3)</sup>
				220-230V 50Hz w. protection <sup>3)</sup>
				24V 50/60Hz 24V= DC
				220-240V 50/60Hz 220V= DC

## 4-pole, With Screw Terminals



3	2	10	4	-	40E	1 HK..	K1-07D40 ...	10	0,16
3	2	10	3	1	31E	1 HK..	K1-07D31 ...	10	0,16
3	2	10	2	2	22E	1 HK..	K1-07D22 ...	10	0,16

# Auxiliary Contact Blocks For Contactor Relays



Ratings	Thermal Rated Current	Contacts <sup>2)</sup> NO NC	Type	Pack pcs.	Weight kg/pc.		
<b>AC15</b>							
<b>230V</b>							
<b>A</b>							
3	2	10	1	1	HK11	10	0,04
3	2	10	-	2	HK02	10	0,04
3	2	10	2	-	HK20	10	0,04
3	2	10	4	-	HK40	10	0,04
3	2	10	2	2	HK22	10	0,04
3	2	10	-	4	HK04	10	0,04

Aux. Contact Blocks

HK11

HK02

HK20

HK40

HK22

HK04

Wiring Diagrams

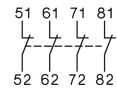
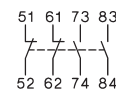
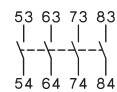



Distinc. Number according to EN50011 for Contactor Relay with Auxiliary Contact Block

K1-07D40	<b>51E</b>	<b>42E</b>	<b>60E</b>	<b>80E</b>	<b>62E</b>	<b>44E</b>
K1-07D31	42Y	33Y	51Y	71Y	53Y	35Y
K1-07D22	33Y	24Y	42Y	62Y	44Y	26Y

Preferable combinations with distinctive letter "..E" according to DIN EN 50011

- 1) Other coil voltages see page 30
- 2) Contacts suitable for electronic circuits, according to EN947-5-4 for rated voltage 24V DC (test ratings 17V DC, 5mA) Mirror contacts acc. IEC60947-4-1 Annex F.
- 3) with built-in coil suppressor (varistor)

# DC Solenoid Operated

Type	Coil voltage <sup>1)</sup>		Contacts <sup>2)</sup>		Additional Contact Blocks	Pack pcs.	Weight kg/pc.	Wiring Diagrams
	24	24VS	NO	NC				
	24V= DC	24V= DC with protection <sup>2)</sup>			Distinc. Number acc. to EN50011			

## 4-pole, With Screw Terminals, Coil 2,5W



<b>K1-07D40= ...</b>	4	-	40E	1 HK..	10	0,19	
----------------------	---	---	-----	--------	----	------	---

<b>K1-07D31= ...</b>	3	1	31E	1 HK..	10	0,19	
----------------------	---	---	-----	--------	----	------	---

<b>K1-07D22= ...</b>	2	2	22E	1 HK..	10	0,19	
----------------------	---	---	-----	--------	----	------	---

## 4-pole, With Screw Terminals, Coil 1,5W, 19 to 30V DC with suppressor <sup>3)</sup>



<b>K1-07D40= 24VR</b>	4	-	-	-	10	0,20	
-----------------------	---	---	---	---	----	------	---

<b>K1-07D31= 24VR</b>	3	1	-	-	10	0,20	
-----------------------	---	---	---	---	----	------	--

<b>K1-07D22= 24VR</b>	2	2	-	-	10	0,20	
-----------------------	---	---	---	---	----	------	---

1) Other coil voltages on request  
 2) Contacts suitable for electronic circuits, according to EN947-5-4 for rated voltage 24V DC (test ratings 17V DC, 5mA) Mirror contacts acc. IEC60947-4-1 Annex F.  
 3) with integrated coil suppressor (Transient Voltage Suppressor Diode)

# Mini Contactors

# AC Operated

Power Ratings	Rated Current	Aux. Contacts <sup>2)</sup>		Type	Coil voltage <sup>1)</sup>	Pack pcs.	Weight kg/pc.
		Built-in	Additional				
AC2, AC3	AC1						
<b>380V</b>					<b>24</b> 24V 50/60Hz		
<b>400V</b> 660V					<b>230</b> 220-230V 50Hz		
<b>415V</b> 690V	690V				<b>24VS</b> 24V 50/60Hz w. protection <sup>3)</sup>		
<b>kW</b> kW	A				<b>230VS</b> 220-230V 50Hz w. protection <sup>3)</sup>		
					<b>24VM</b> 24V 50/60Hz 24V= DC		
					<b>230VM</b> 220-240V 50/60Hz 220V= DC		



## 3-pole, With Screw Terminals

Rated Current	Rated Voltage	Rated Power	Built-in	Additional	Type	Pack pcs.	Weight kg/pc.
4	4	20	1	-	1 HKM..	<b>K1-09D10 ...</b>	10 0,16
5,5	5,5	20	1	-	1 HKM..	<b>K1-12D10 ...</b>	10 0,16

Rated Current	Rated Voltage	Rated Power	Built-in	Additional	Type	Pack pcs.	Weight kg/pc.
4	4	20	-	1	1HK..	<b>K1-09D01 ...</b>	10 0,16
5,5	5,5	20	-	1	1HK..	<b>K1-12D01 ...</b>	10 0,16

## 4-pole, With Screw Terminals

Rated Current	Rated Voltage	Rated Power	Built-in	Additional	Type	Pack pcs.	Weight kg/pc.
4	4	20	-	-	1HK..	<b>K1-09D00-40 ...</b>	10 0,16
5,5	5,5	20	-	-	1HK..	<b>K1-12D00-40 ...</b>	10 0,16

# Auxiliary Contact Blocks for Contactors K1-..

Ratings	Thermal Rated Current	Contacts <sup>2)</sup>	Type	Pack pcs.	Weight kg/pc.
<b>AC15</b>					
<b>230V</b>	400V				
<b>A</b>	A	A	NO NC		
<b>3</b>	2	10	1 1	<b>HKM11</b>	10 0,04
<b>3</b>	2	10	- 2	<b>HKM02</b>	10 0,04
<b>3</b>	2	10	2 2	<b>HKM22</b>	10 0,04

Aux. Contact Blocks

HKM11

HKM02

HKM22

Wiring Diagrams

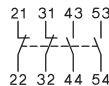

Contactors with Auxiliary Contact Block

Contacts according to EN50012

K1-..D10	21	12	32	-	-	-	-
----------	----	----	----	---	---	---	---

Contacts according to DIN EN50005

K1-..D01	-	-	-	12	03	41	23
K1-..D00-40	-	-	-	11	02	40	22

Prefer combinations according to EN50012

# Suppressor Units for Contactors K1-..



Voltage Range V		Type	Pack pcs.	Weight kg/pc.
12 - 48V AC/DC	1600nF / 22 Ohm	<b>RC-K1 24</b>	10	0,01
48 - 127V AC/DC	680nF / 270 Ohm	<b>RC-K1 110</b>	10	0,01
110 - 250V AC/DC	220nF / 2200 Ohm	<b>RC-K1 230</b>	10	0,01

1) Other coil voltages see page 30

2) Contacts suitable for electronic circuits, according to EN947-5-4 for rated voltage 24V DC (test ratings 17V DC, 5mA) Mirror contacts acc. IEC60947-4-1 Annex F.



3) with built-in coil suppressor (varistor)

# DC Solenoid Operated

## Type

Coil voltage <sup>1)</sup>  
**24** 24V= DC  
**24VS** 24V= DC with protection <sup>3)</sup>



Aux. Contacts <sup>2)</sup>  
 Built in Additional  
   
 NO NC

Additional Overload Relay  
 see page 114  
 Type

Pack pcs. Weight kg/pc.

Wiring Diagrams



### 3-pole, With Screw Terminals, Coil 2,5W

<b>K1-09D10= ...</b>	1	-	1 HKM..	U12/16..K1	10	0,19
<b>K1-12D10= ...</b>	1	-	1 HKM..	U12/16..K1	10	0,19

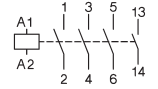

<b>K1-09D01= ...</b>	-	1	1 HK..	U12/16..K1	10	0,19
<b>K1-12D01= ...</b>	-	1	1 HK..	U12/16..K1	10	0,19

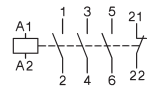

### 4-pole, With Screw Terminals, Coil 2,5W

<b>K1-09D00-40= ...</b>	-	-	-	U12/16..K1	10	0,19
<b>K1-12D00-40= ...</b>	-	-	-	U12/16..K1	10	0,19

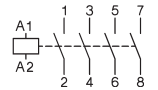

### 3-pole, With Screw Terminals, Coil 1,5W, 19 to 30V DC with suppressor <sup>3)</sup>

<b>K1-09D10=24VR</b>	1	-	-	U12/16..K1	10	0,20
----------------------	---	---	---	------------	----	------

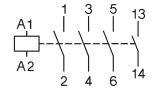

<b>K1-09D01= 24VR -</b>	-	1	-	U12/16..K1	10	0,20
-------------------------	---	---	---	------------	----	------

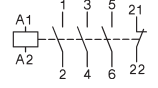

1) Other coil voltages on request  
 2) Contacts suitable for electronic circuits, according to EN947-5-4 for rated voltage 24V DC (test ratings 17V DC, 5mA) Mirror contacts acc. IEC60947-4-1 Annex F.  
 3) with integrated coil suppressor (Transient Voltage Suppressor Diode)

# Mini Contactors

# AC Operated

Power Ratings	Rated Current	Aux. Contacts <sup>2)</sup>		Type	Coil voltage <sup>1)</sup>
		Built in	Additional		
AC2, AC3	AC1				24V 50/60Hz
<b>380V</b>					220-230V 50Hz
<b>400V</b>	660V				24V 50/60Hz w. protection <sup>2)</sup>
<b>415V</b>	690V	690V			220-230V 50Hz w. protection <sup>2)</sup>
<b>kW</b>	<b>kW</b>	<b>A</b>			24V 50/60Hz 24V DC
			NO NC	Type	230VM 220-240V 50/60Hz 220V DC
					Pack Weight pcs. kg/pc.

### 3-pole, with Fast On Tab Connectors 1 x 6,3mm or 2 x 2,8mm



4	4	16	1	-	1 HKM..	<b>K1-09F10</b> ...	10	0,16
4	4	16	-	1	1 HK..	<b>K1-09F01</b> ...	10	0,16

### 3-pole, with Solder Pins Ø1,15 for Printed Circuit Applications



4	4	16	1	-	-	<b>K1-09L10</b> ...	10	0,16
4	4	16	-	1	-	<b>K1-09L01</b> ...	10	0,16

### 4-pole, with Solder Pins Ø1,15 for Printed Circuit Applications

4	4	16	-	-	-	<b>K1-09L00-40</b> ...	10	0,16
---	---	----	---	---	---	------------------------	----	------

## Coil voltages for AC operated contactors

Suffix to contactor type e.g. K1-09D10 24	Voltage Marking at the coil for		Rated Control Voltage U <sub>s</sub> range for 50Hz for 60Hz			
	50Hz	60Hz	min.	max.	min.	max.
12	12	12	11	12	12	12
<b>24</b>	<b>24</b>	<b>24</b>	<b>22</b>	<b>24</b>	<b>24</b>	<b>24</b>
42	42	42	38,5	42	42	42
48	48	48	48	50	48	52
90	100	100	90	100	100	105
95	95-100	105-110	95	100	105	110
100	100	110-115	100	105	110	115
105	105-110	115-120	105	110	115	120
110	110-115	120-125	110	115	120	125
180	200	200	185	200	200	210

Suffix to contactor type e.g. K1-09D10 230	Voltage Marking at the coil for		Rated Control Voltage U <sub>s</sub> range for 50Hz for 60Hz			
	50Hz	60Hz	min.	max.	min.	max.
200	200	200-220	195	205	200	220
210	205-215	220-230	205	215	220	230
220	210-220	220-240	210	220	220	240
<b>230</b>	<b>220-230</b>	<b>230-250</b>	<b>220</b>	<b>230</b>	<b>230</b>	<b>250</b>
240	230-240	240-260	230	240	240	260
400	380-400	400-440	380	400	400	440
500	475-500	520-545	475	500	520	545
550	525-550	600	525	550	570	600

**Standard voltages in bold type letters**  
**Operating range of magnet-coils: 0,85 x U<sub>s</sub> (min. value of rated control voltage) up to 1,1 x U<sub>s</sub> (max. value of rated control voltage)**

Coil not exchangeable

1) Other coil voltages see page 28

2) Contacts suitable for electronic circuits, according to EN947-5-4 for rated voltage 24V DC (test ratings 17V DC, 5mA) Mirror contacts acc. IEC60947-4-1 Annex F.

3) with built-in coil suppressor (varistor)

# DC Solenoid Operated

## Type

Coil voltage <sup>1)</sup>	Aux. Contacts <sup>2)</sup>	Additional	Pack	Weight
<b>24</b> 24V= DC	Built	Overload	pcs.	kg/pc.
<b>24VS</b> 24V= DC with protection <sup>3)</sup>	in	Relay see pages 115, 117		
↓	NO NC	Type		



### 3-pole, with Fast On Tab Connectors 1 x 6,3mm or 2 x 2,8mm

<b>K1-09F10= . . .</b>	1	-	1 HKM.. <sup>4)</sup>	10	0,19
------------------------	---	---	-----------------------	----	------

Wiring Diagrams

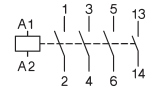

<b>K1-09F01= . . .</b>	-	1	1 HK.. <sup>4)</sup>	10	0,19
------------------------	---	---	----------------------	----	------

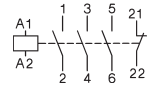

### 3-pole, with Solder Pins Ø1,15 for Printed Circuit Applications



<b>K1-09L10= . . .</b>	1	-	-	10	0,19
------------------------	---	---	---	----	------

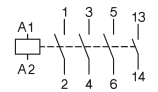

<b>K1-09L01= . . .</b>	-	1	-	10	0,19
------------------------	---	---	---	----	------

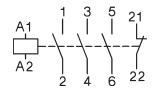

### 4-pole, with Solder Pins Ø1,15 for Printed Circuit Applications

<b>K1-09L00-40= . . .</b>	-	-	-	10	0,19
---------------------------	---	---	---	----	------

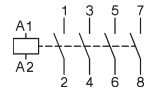

1) Other coil voltages on request  
 2) Contacts suitable for electronic circuits, according to EN947-5-4 for rated voltage 24V DC (test ratings 17V DC, 5mA) Mirror contacts acc. IEC60947-4-1 Annex F.  
 3) with integrated coil suppressor (Transient Voltage Suppressor Diode)  
 4) U12/16E K3 with U12SMK3 for single mounting

# Mini Reversing Contactors, Mechanical Interlocked

AC Operated

Power Ratings	Rated Current	AC1	Aux. Contacts <sup>2)</sup>		Type	Coil voltage <sup>1)</sup>	Pack pcs.	Weight kg/pc.
			Built-in	Additional on left hand side Contactor				
AC2, AC3						24V 50/60Hz		
<b>380V</b>						220-230V 50Hz		
<b>400V</b>	660V					24V 50/60Hz w. protection <sup>3)</sup>		
<b>415V</b>	690V	690V				220-230V 50Hz w. prot. <sup>3)</sup>		
<b>kW</b>	<b>kW</b>	<b>A</b>				24V 50/60Hz 24V DC		
			NO NC	Type		220-240V 50/60Hz 220V DC		

## 3-pole, with Screw Terminals



<b>4</b>	4	20	-	2	HKM11V	HKM11X	<b>K1W09D01MC ...</b>	1	0,32
<b>5,5</b>	5,5	20	-	2	HKM11V	HKM11X	<b>K1W12D01MC ...</b>	1	0,32
<b>4</b>	4	20	2	-	HKM..		<b>K1W09D10MC ...</b>	1	0,32
<b>5,5</b>	5,5	20	2	-	HKM..		<b>K1W12D10MC ...</b>	1	0,32

## 4-pole, with Screw Terminals

<b>4</b>	4	20	-	-	HKM..		<b>K1W09D00-40MC ..</b>	1	0,32
<b>5,5</b>	5,5	20	-	-	HKM..		<b>K1W12D00-40MC ..</b>	1	0,32

## 3-pole, with Solder Pins Ø1,15 for Printed Circuit Applications

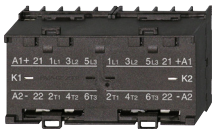

<b>4</b>	4	16	-	2	-	-	<b>K1W09L01MC ...</b>	1	0,32
<b>4</b>	4	16	2	-	-	-	<b>K1W09L10MC ...</b>	1	0,32

# Auxiliary Contact Blocks for Mini Reversing Contactors K1-..

Ratings	AC15	400V	Thermal Rated Current	Contacts <sup>2)</sup>		Type	Pack pcs.	Weight kg/pc.
				NO	NC			
<b>3</b>	2		10	1	1	<b>HKM11V</b>	10	0,04
<b>3</b>	2		10	1	1	<b>HKM11X</b>	10	0,04



Aux. Contact Blocks

HKM11V      HKM11X

Wiring Diagrams



# Reversing Starter Connector



For Reversing Starter Types, incl. Coil Connector

Type	Pack pcs.	Weight kg/pc.
<b>K1W09D..MC, K1W12D..MC</b>	<b>1</b>	<b>0,01</b>

1) Other coil voltages see page 30  
 2) Contacts suitable for electronic circuits, according to EN947-5-4 for rated voltage 24V DC (test ratings 17V DC, 5mA) Mirror contacts acc. IEC60947-4-1 Annex F.  
 3) with built-in coil suppressor (varistor)

# DC Solenoid Operated

## Type

**24** Coil voltage <sup>1)</sup>  
**24VS** 24V= DC  
 ↓ 24V= DC with protection <sup>2)</sup>

Additional  
 Overload  
 Relay  
 see  
 page114  
 Type

Pack pcs. Weight kg/pc.

Wiring Diagrams

### 3-pole, with Screw Terminals



K1W09D01MC= ...	U12/16..K1	1	0,32
K1W12D01MC= ...	U12/16..K1	1	0,32

K1W09D10MC= ...	U12/16..K1	1	0,32
K1W12D10MC= ...	U12/16..K1	1	0,32

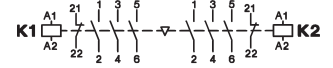

### 4-pole, with Screw Terminals

K1W09D00-40MC= ..	U12/16..K1	1	0,32
K1W12D00-40MC= ..	U12/16..K1	1	0,32

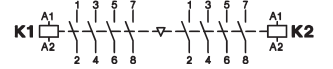

### 3-pole, with Solder Pins Ø1,15 for Printed Circuits Applications



K1W09L01MC= ...	-	1	0,32
-----------------	---	---	------

K1W09L10MC= ...	-	1	0,32
-----------------	---	---	------

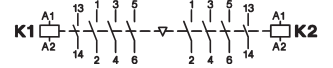
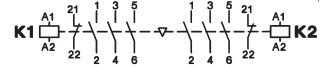

1) Other coil voltages on request  
 2) with integrated coil suppressor (Transient Voltage Suppressor Diode)



# Mini Contactors

Data according to IEC 947-4-1, VDE 0660, EN 60947-4-1

Main Contacts	Type	K1-09D..	K1-09F..	K1-09L..	K1-12D..
<b>Rated insulation voltage <math>U_i</math></b>	V AC	690 <sup>1)</sup>	690 <sup>1)</sup>	690 <sup>2)</sup>	690 <sup>1)</sup>
<b>Making capacity <math>I_{eff}</math></b>	at $U_e = 690V$ AC	A	165	165	165
<b>Breaking capacity <math>I_{eff}</math></b>	400V AC	A	100	100	100
$\cos\varphi = 0,65$	500V AC	A	90	90	90
	690V AC	A	80	80	80
<b>Utilization category AC1</b>					
<b>Switching of resistive load</b>					
Rated operational current $I_e (=I_{th})$ at 40°C, open	<b>A</b>	<b>20</b>	<b>16</b>	<b>16</b>	<b>20</b>
Rated operational power of three-phase resistive loads					
50-60Hz, $\cos\varphi = 1$	230V kW	7,9	6	6	7,9
	240V kW	8,3	6,5	6,5	8,3
	400V kW	13,8	11	11	13,8
	415V kW	14,3	11,5	11,5	14,3
Rated operational current $I_e (=I_{the})$ at 60°C, enclosed	A	16	12	12	16
Rated operational power of three-phase resistive loads					
50-60Hz, $\cos\varphi = 1$	230V kW	6,3	4,5	4,5	6,3
	240V kW	6,7	5	5	6,7
	400V kW	11	8	8	11
	415V kW	11,5	8,5	8,5	11,5
Minimum cross-section of conductor at load with $I_e (=I_{th})$	mm <sup>2</sup>	2,5	2,5	-	2,5
<b>Utilization category AC2 and AC3</b>					
<b>Switching of three-phase motors</b>					
Rated operational current $I_e$					
open and enclosed	220V A	12	12	12	15
	230V A	11,5	11,5	11,5	14,5
	240V A	11	11	11	14
	<b>380-400V A</b>	<b>9</b>	<b>9</b>	<b>9</b>	<b>12</b>
	415-440V A	8	8	8	11
	500V A	7	7	7	9
	660-690V A	5	5	5	6,5
Rated operational power of three-phase motors					
50-60Hz	220-240V kW	3	3	3	4
	<b>380-440V kW</b>	<b>4</b>	<b>4</b>	<b>4</b>	<b>5,5</b>
	500-690V kW	4	4	4	5,5
<b>Utilization category AC4</b>					
<b>Switching of squirrel cage motors, inching</b>					
Rated operational current $I_e$					
open and enclosed	220V A	12	12	12	15
	230V A	11,5	11,5	11,5	14,5
	240V A	11	11	11	14
	<b>380-400V A</b>	<b>9</b>	<b>9</b>	<b>9</b>	<b>12</b>
	415-440V A	8	8	8	11
	500V A	7	7	7	9
	660-690V A	5	5	5	6,5
Rated operational power of three-phase motors					
50-60Hz	220-240V kW	3	3	3	4
	<b>380-440V kW</b>	<b>4</b>	<b>4</b>	<b>4</b>	<b>5,5</b>
	500-690V kW	4	4	4	5,5
<b>Utilization category AC5a</b>					
<b>Switching of gas discharge lamps</b>					
Rated operational current $I_e$					
per pole at 220/230V					
Fluorescent lamps,					
uncompensated and serial compensated	A	10	10	10	10
parallel compensated	A	2	2	2	2
dual-connection	A	16	16	16	16
Metal halide lamps <sup>3)</sup> ,					
uncompensated	A	10	10	10	10
parallel compensated	A	2	2	2	2
Mercury-vapour lamps <sup>4)</sup> ,					
uncompensated	A	16	16	16	16
parallel compensated	A	2	2	2	2
Mixed light lamps <sup>5)</sup>	A	16	61	16	16
<b>LED-Lamps</b>					
consider the inrush current of the lamp ballast					
and $\cos\varphi$ of the lamp	max. lamps per pole ( $I_{rLED} \leq I_{th}$ )	=	inrush current of contactor		
			inrush current of lamp/EVG		
max inrush current of contactor	A	233	233	233	233

## Utilization category AC5b Switching of incandescent lamps <sup>6)</sup>

Rated operational current  $I_e$

1) Suitable at 690V for: earthed-neutral systems, overvoltage category I to IV, pollution degree 3 (standard-industry);  $U_{imp} = 8kV$ . Data for other conditions on request.

2) Suitable at 690V for pollution degree 2,  $U_{imp} = 6kV$ .

Pollution degree 3  $U_i = 690V$  non-tracking of the printed circuit CTI  $\geq 600$

Pollution degree 3  $U_i = 500V$  non-tracking of the printed circuit CTI  $\geq 400$

Pollution degree 3  $U_i = 400V$  non-tracking of the printed circuit CTI  $\geq 100$

3) Metal halide lamps and sodium-vapour lamps (high- and low-pressure lamps)

4) High-pressure lamps

5) Blended lamps, containing a mercury high-pressure unit and a tungsten helix in a fluorescent glass bulb (daylight lamps)

6) Current inrush approx.  $16 \times I_e$

# Mini Contactors

## Data according to IEC 947-4-1, VDE 0660, EN 60947-4-1

Main Contacts	Type	K1-09D..	K1-09F..	K1-09L..	K1-12D..	
<b>Utilization category DC1</b>						
<b>Switching of resistive load</b>	1 pole 24V	A	20	16	16	20
Time constant L/R ≤15ms	60V	A	20	16	16	20
Rated operational current I <sub>e</sub>	110V	A	5	5	5	5
	220V	A	0,6	0,6	0,6	0,6
3 poles in series	24V	A	20	20	20	20
	60V	A	20	20	20	20
	110V	A	20	20	20	20
	220V	A	16	16	16	16
<b>Utilization category DC3 and DC5</b>						
<b>Switching of shunt motors and series motors</b>	1 pole 24V	A	20	16	16	20
Time constant L/R ≤15ms	60V	A	5	5	5	5
Rated operational current I <sub>e</sub>	110V	A	1	1	1	1
	220V	A	0,15	0,15	0,15	0,15
3 poles in series	24V	A	20	16	16	20
	60V	A	20	16	16	20
	110V	A	20	16	16	20
	220V	A	2	2	2	2
<b>Maximum ambient temperature</b>						
Operation	open	°C	-40 to +60 (+90) <sup>1)</sup>			
	enclosed	°C	-40 to +40			
with thermal overload relay	open	°C	-25 to +60			
	enclosed	°C	-25 to +40			
Storage		°C	-50 to +90			
<b>Short circuit protection</b>						
for contactors without thermal overload relay						
Coordination-type "1" according to IEC 947-4-1						
Contact welding without hazard of persons max. fuse size	gL (gG)	A	40	40	40	40
Coordination-type "2" according to IEC 947-4-1						
Light contact welding accepted max. fuse size	gL (gG)	A	25	25	25	25
Contact welding not accepted max. fuse size	gL (gG)	A	10	10	10	10
For contactors with thermal overload relay the device with the smaller admissible backup fuse (contactor or thermal overload relay) determines the fuse size.						
<b>Cable cross-sections</b>						
for contactors without thermal overload relay						
main connector	solid or stranded	mm <sup>2</sup>	0,5 - 2,5	Fast on	Solder connector	0,5 - 2,5
		mm <sup>2</sup>	0,5 - 2,5	1x 6,3 x 0,8	Ø 1,15	0,5 - 2,5
Cables per clamp	flexible with multicore cable end	mm <sup>2</sup>	0,5 - 1,5	or	-	0,5 - 1,5
			2	2x 2,8 x 0,8		2
	solid or stranded	AWG	18 - 14			18 - 14
<b>Frequency of operations z</b>						
Contactors without thermal overload relay						
	without load	1/h	10000	10000	10000	10000
	AC3, I <sub>e</sub>	1/h	600	600	600	700
	AC4, I <sub>e</sub>	1/h	120	120	120	150
	DC3, I <sub>e</sub>	1/h	600	600	600	700
<b>Mechanical life</b>						
AC operated	S x	10 <sup>6</sup>	5	5	5	5
DC operated	S x	10 <sup>6</sup>	15	15	15	15
<b>Short time current</b>						
	10s-current	A	96	96	96	120
<b>Power loss per pole</b>						
	at I <sub>e</sub> /AC3 400V	W	0,15	0,15	0,15	0,25
<b>Resistance to shock according to IEC 68-2-27</b>						
Shock time 20ms sine-wave						
AC operated	NO	g	5	5	5	5
	NC	g	5	5	5	5
DC operated	NO	g	8	8	8	8
	NC	g	6	6	6	6

1) With reduced control voltage range 0,9 up to 1,0 x U<sub>s</sub> and with reduced rated current I<sub>e</sub>/AC1 according to I<sub>e</sub>/AC3

# Mini Contactors

## Data according to IEC 947-5-1, VDE 0660, EN 60947-5-1

Auxiliary Contacts			Type	K1-07D.. K1-09D.. K1-12D..	K1-07D..=(VM) K1-09D..=(VM) K1-12D..=(VM)	K1-07D..= 24VR K1-09D..= 24VR	K1-09F..=(VM)	K1-07L..=(VM) K1-09L..=(VM)	HK..
<b>Rated insulation voltage <math>U_i</math></b>			V AC	690 <sup>1)</sup>	690 <sup>1)</sup>	690 <sup>1)</sup>	690 <sup>1)</sup>	690 <sup>2)</sup>	690 <sup>1)</sup>
<b>Thermal rated current <math>I_{th}</math> to 690V</b>									
Ambient temperature			40°C A	10	10	10	10	10	10
			60°C A	6	6	6	6	6	6
<b>Power loss per pole</b>			at $I_{th}$ W	0,5	0,5	0,5	0,5	0,5	0,5
<b>Utilization category AC15</b>									
Rated operational current $I_e$			220-240V A	3	3	3	3	3	3
			380-415V A	2	2	2	2	2	2
			440V A	1,6	1,6	1,6	1,6	1,6	1,6
			500V A	1,2	1,2	1,2	1,2	1,2	1,2
			660-690V A	0,6	0,6	0,6	0,6	0,6	0,6
<b>Utilization category DC13</b>									
Rated operational current $I_e$			60V A	2	2	2	2	2	2
			110V A	0,4	0,4	0,4	0,4	0,4	0,4
			220V A	0,1	0,1	0,1	0,1	0,1	0,1
<b>Maximum ambient temperature</b>									
Operation			open °C	-40 to +60 (+90) <sup>3)</sup>					
			enclosed °C	-40 to +40					
Storage			°C	-40 to +90					
<b>Short circuit protection</b>									
short-circuit current 1kA, contact welding not accepted max. fuse size			gL (gG) A	20	20	20	20	20	20
For contactors with thermal overload relay the device with the smaller admissible control fuse (contactor or thermal overload relay) determines the fuse size.									
<b>Power consumption of coils</b>									
AC operated			inrush VA	25	-	-	25	25	-
			sealed VA	4 - 5	-	-	4 - 5	4 - 5	-
			W	1,2	-	-	1,2	1,2	-
DC operated			inrush W	-	2,5	1,5	2,5	2,5	-
and ...VM (AC/DC)			sealed W	-	2,5	1,5	2,5	2,5	-
<b>Operation range of coils</b>									
in multiples of control voltage $U_s$				0,85 - 1,1	0,8 - 1,1	19 - 30V DC	0,85 - 1,1	0,85 - 1,1	-
<b>Switching time at control voltage <math>U_s \pm 10\%</math> <sup>4) 5)</sup></b>									
AC operated			make time ms	15 - 19	-	-	15 - 19	15 - 19	-
			release time ms	8 - 25	-	-	8 - 25	8 - 25	-
			arc duration ms	10 - 15	-	-	10 - 15	10 - 15	-
DC operated			make time ms	-	15 - 50	15 - 50	15 - 50	15 - 50	-
			release time ms	-	8 - 25	8 - 25	8 - 25	8 - 25	-
			arc duration ms	-	10 - 15	10 - 15	10 - 15	10 - 15	-
<b>Cable cross-section</b>									
all connectors			solid mm <sup>2</sup>	0,5 - 2,5	0,5 - 2,5	0,5 - 2,5	Fast on	Solder connector	0,5 - 2,5
			flexible mm <sup>2</sup>	0,5 - 2,5	0,5 - 2,5	0,5 - 2,5	1x 6,3 x 0,8	Ø 1,15	0,5 - 2,5
			flexible with multicore cable end mm <sup>2</sup>	0,5 - 1,5	0,5 - 1,5	0,5 - 1,5	or		0,5 - 1,5
							2x 2,8 x 0,8		
Clamps per pole				2	2	2	-	-	2
			solid or stranded AWG	18 - 14	18 - 14	18 - 14			18 - 14

1) Suitable at 690V for: earthed-neutral systems, overvoltage category I to IV, pollution degree 3 (standard-industry):  $U_{imp} = 8kV$ .  
Data for other conditions on request.

2) Suitable at 690V for pollution degree 2,  $U_{imp} = 6kV$ .  
Pollution degree 3  $U_i = 690V$  non-tracking of the printed circuit CTI  $\geq 600$   
Pollution degree 3  $U_i = 500V$  non-tracking of the printed circuit CTI  $\geq 400$   
Pollution degree 3  $U_i = 400V$  non-tracking of the printed circuit CTI  $\geq 100$

3) With reduced control voltage range 0,9 up to  $1,0 \times U_s$  and with reduced thermal rated current  $I_{th}$  to  $I_e/AC15$

4) Summary switching time = release time + arc duration

5) Release time of NC make time of NO increase when suppressor units for voltage peak protection are used (Varistor, RC-units, Diode units).

# Mini Contactors for North America

## Data according to UL508

Main Contacts (cULus)		Type	K1-09D.. K1W09D01	K1-09F..	K1-09L..	K1-07D..	K1-12D.. K1W12D01	HK..
Rated operational current "General Use"		A	15	15	20	10	20	10
Rated operational power of three-phase motors at 60Hz (3ph)	110-120V	hp	1½	1½	1½	-	2	-
	200-208V	hp	3	3	3	-	3	-
	220-240V	hp	3	3	3	-	3	-
	440-480V	hp	5	5	5	-	7½	-
	550-600V	hp	7½	7½	7½	-	10	-
Rated operational power of AC motors at 60Hz (1ph)	110-120V	hp	½	½	½	-	¾	-
	200-208V	hp	1	1	1	-	1½	-
	220-240V	hp	1½	1½	1½	-	2	-
Fuse / Short-circuit current		A/kA	30/5	30/5	30/5	-	30/5	-
Rated voltage		V AC	600	600	600 <sup>1)</sup>	600	600	600
<b>Auxiliary Contacts (cULus)</b>		heavy pilot duty standard pilot duty	AC DC	A600 Q600	A600 Q600	A600 Q600	A600 Q600	A600 Q600

### Motor Rating P<sub>n</sub> = AC4

660/690V	500V	380/400V	220/230V
kW	kW	kW	kW
110	75	55	30
90	55	45	22
75	45	37	18,5
55	37	30	15
45	30	22	11
37	22	18,5	7,5
30	18,5	15	5,5
22	15	11	4
18,5	11	7,5	3
15	7,5	5,5	2,2
11	5,5	4	1,5
7,5	4	3	1,1
5,5	3	2,2	0,75
4	2,2	1,5	0,55
3	1,5	1,1	0,37
2,2	1,1	0,75	0,25
1,5	0,75	0,55	
1,1	0,55	0,37	
0,75	0,37	0,25	
0,55	0,25		
0,37			
0,25			

### Motor Rating P<sub>n</sub> = AC3

660/690V	500V	380/400V	220/230V
kW	kW	kW	kW
600	400	315	200
600	315	250	160
400	250	200	132
315	200	160	110
250	160	132	90
200	132	110	75
160	110	90	55
132	90	75	45
110	75	55	37
90	55	45	30
75	45	37	22
55	37	30	18,5
45	30	22	15
37	22	18,5	11
30	18,5	15	7,5
22	15	11	5,5
18,5	11	7,5	4
15	7,5	5,5	3
11	5,5	4	2,2
7,5	4	3	1,5
5,5	3	2,2	1,1
4	2,2	1,5	0,75
3	1,5	1,1	0,55
2,2	1,1	0,75	0,37
1,5	0,75	0,55	0,25
1,1	0,55	0,37	
0,75	0,37	0,25	
0,55	0,25		
0,37			
0,25			

### Breaking Current I<sub>a</sub> (= I<sub>e</sub> = AC1) A

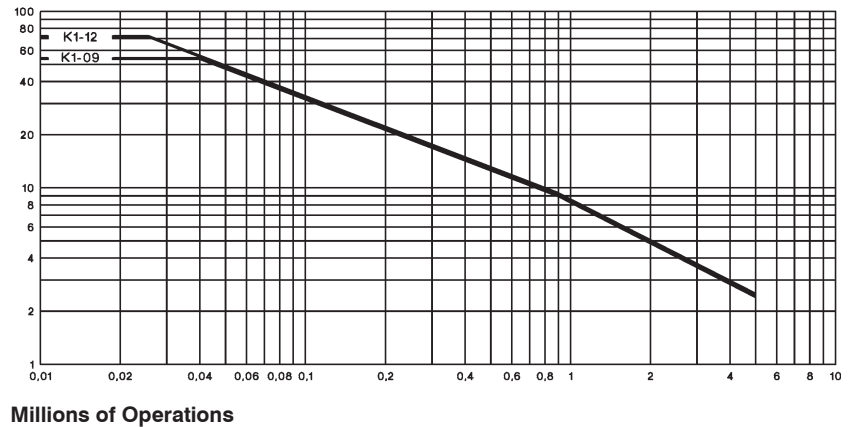

1) Pollution degree	CTI - PWB	U <sub>i</sub>
2	≥ 100	600V
3	≥ 400	480V
3	100 - 400	240V

Contactors, Motor-Starters  
 Circuit Breakers  
 Manual Motor-Starters  
 Switches  
 AC-Main Switches  
 DC-Switch Disconnectors  
 Push Buttons  
 Representatives, Suppliers

# Mini Contactors

## Dimensions

**AC and DC operated**  
with screw terminals

**K1-07D..**  
**K1-09D..**  
**K1-12D..**

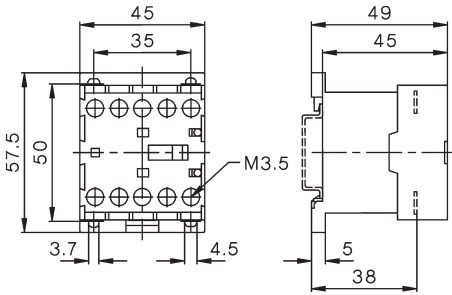

with fast on terminals

**K1-07F..**  
**K1-09F..**

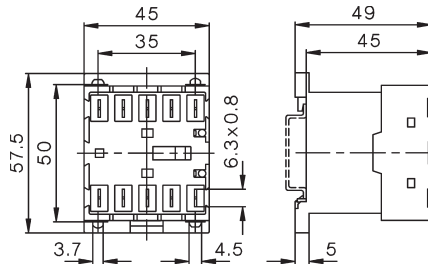

**AC and DC operated**  
with solder connections

**K1-07L..**  
**K1-09L..**

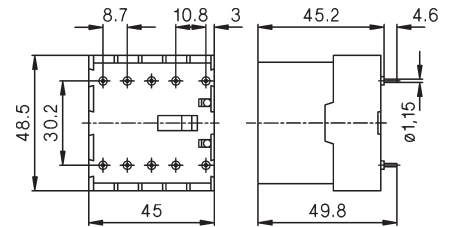

## Auxiliary Contact Blocks

**HK..**

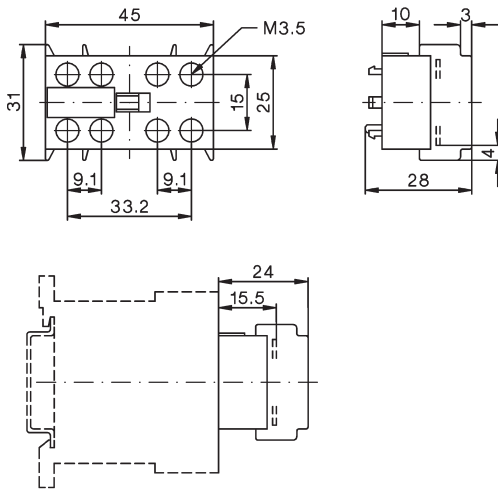

## Suppressor Units

**RC-K1**

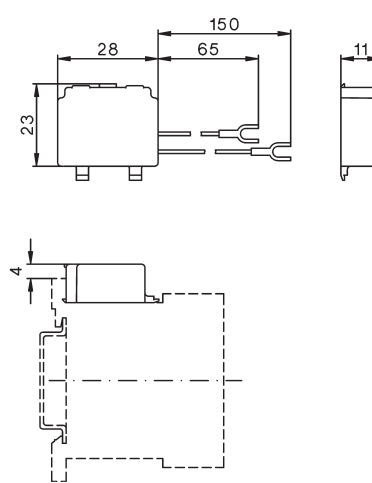

## Reversing Contactors

**K1W09D..MC**  
**K1W12D..MC**

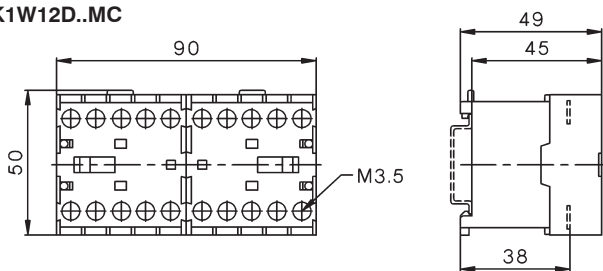

## Reversing Contactors

**K1W09L..MC**

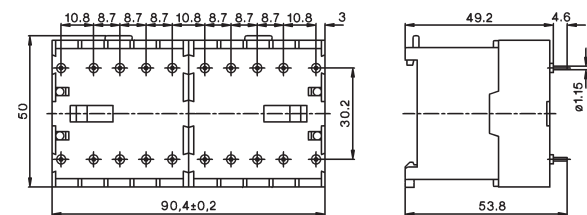

**K1-09 + U12/16.. K1**  
**K1-12**

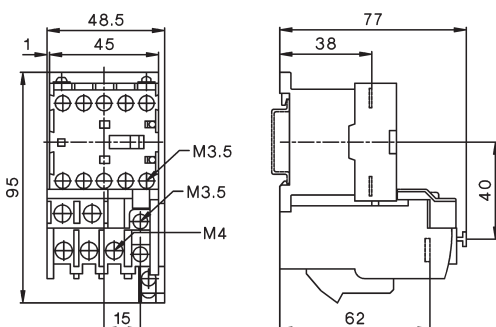

**K1W09D..MC + U12/16E K1**  
**K1W09D..MC + U12/16E K1**

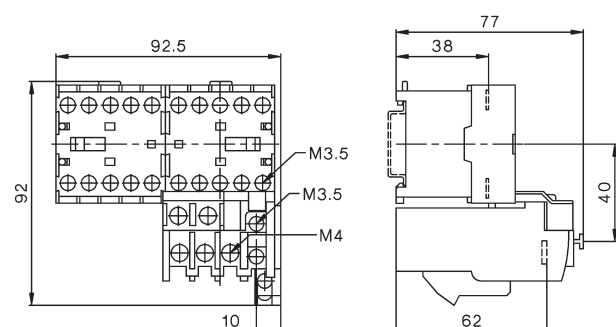



Contactor Relays 4-pole, AC Operated

40



Auxiliary Contact Blocks 1-pole

40



Contactor Relays 4-pole, DC Operated

41



Technical Data

42

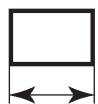

Dimensions

44

## Contactor Relays

AC Operated

Ratings		Contacts				Type	Coil voltage <sup>1)</sup>				
AC15	Therm. Rated Current	Built-in	Distinc. Number acc. to	Additional Contact Blocks		24	110	230	400		
230V	400V					24V 50/60Hz	110V 50Hz	110-120V 60Hz	220-240V 50Hz	230-264V 60Hz	400-440V 60Hz
A	A	$I_{th}$	NO NC	EN50011	Type						Pack Weight pcs. kg/pc.



### 4-pole, contacts suitable for electronic circuits according to EN947-5-4<sup>2)</sup>

4	2	10	4	-	40E	max. 4	K3-07ND40 ...	1	0,22
4	2	10	3	1	31E	HN..	K3-07ND31 ...	1	0,22
4	2	10	2	2	22E		K3-07ND22 ...	1	0,22
4	2	10	-	4	04E		K3-07ND04 ...	1	0,22

## Auxiliary Contact Blocks <sup>3)</sup>

Ratings		Thermal Rated Current		Contacts <sup>2)</sup>				Type	Pack pcs.	Weight kg/pc.
AC15	230V	400V	A	NO	NC	EM	LB			
A	A	A	A							



### 1-pole, contacts suitable for electronic circuits according to EN947-5-4<sup>2)</sup>

3	2	10	1	-	-	-	HN10	10	0,02
3	2	10	-	1	-	-	HN01	10	0,02
3	2	10	-	-	1	-	HN10U	10	0,02
3	2	10	-	-	-	1	HN01U	10	0,02

### 1-pole, for high switching capacity

6	3	25	1	-	-	-	HA10	10	0,03
6	3	25	-	1	-	-	HA01	10	0,03

Accessories see page 52 - 55

1) Other coil voltages see page 57

2) Contacts suitable for electronic circuits, according to EN947-5-4 for rated voltage 24V DC (test ratings 17V DC, 5mA) Mirror contacts acc. IEC60947-4-1 Annex F.

3) Technical Data see page 62

## DC Operated

Type	Coil voltage <sup>1)</sup>		Contacts			Pack pcs.	Weight kg/pc.	Wiring Diagrams
			Built-in	Distinc. Number acc. to	Additional Contact Blocks			
	<b>24</b>	24V DC						
	<b>48</b>	48V DC						
	<b>110</b>	110V DC						
	<b>220</b>	220V DC						
	↓		NO	NC	EN50011	Type		



### 3W Coil power, for high switching capacity <sup>3)</sup>

<b>KG3-07A40</b> ...	4	-	40E	max. 4	1	0,53	A40, D40
<b>KG3-07A31</b> ...	3	1	31E	HN..	1	0,53	A31, D31
<b>KG3-07A22</b> ...	2	2	22E	oder	1	0,53	A22, D22
<b>KG3-07A04</b> ...	-	4	04E	HA..	1	0,53	A04, D04

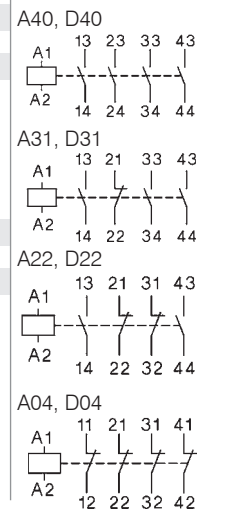

### 3W Coil power, for electronic circuits <sup>2)3)</sup>

<b>KG3-07D40</b> ...	4	-	40E	max. 4	1	0,53	A40, D40
<b>KG3-07D31</b> ...	3	1	31E	HN..	1	0,53	A31, D31
<b>KG3-07D22</b> ...	2	2	22E		1	0,53	A22, D22
<b>KG3-07D04</b> ...	-	4	04E		1	0,53	A04, D04

### with double winding coil, for electronic circuits <sup>2)</sup>

<b>K3-07ND40=</b> ...	4	-	40E	max. 3	1	0,25	ND40=
<b>K3-07ND31=</b> ...	3	1	31E	HN..	1	0,25	ND31=
<b>K3-07ND22=</b> ...	2	2	22E		1	0,25	ND22=
<b>K3-07ND04=</b> ...		-4	04E		1	0,25	ND04=

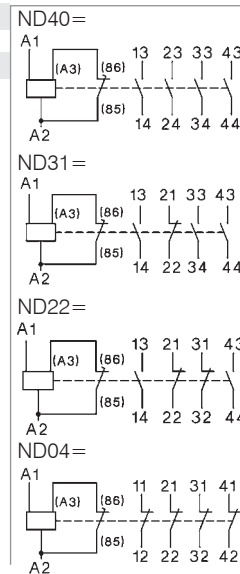

- 1) Other coil voltages on request
- 2) Contacts suitable for electronic circuits, according to EN947-5-4 for rated voltage 24V DC (test ratings 17V DC, 5mA) Mirror contacts acc. IEC60947-4-1 Annex F.
- 3) with integrated coil suppressor (Transient Voltage Suppressor Diode)



# Contactors Relays

## Data according to IEC 947-5-1, VDE 0660, EN 60947-5-1

			Type	K3-07ND	K3-07ND=	KG3-07A	KG3-07D
<b>Rated insulation voltage <math>U_i^{1)}</math></b>			V AC	690	690	690	690
<b>Thermal rated current <math>I_{th}</math> to 690V</b>							
Ambient temperature			40°C A	10	10	20	10
			60°C A	6	6	16	6
<b>Frequency of operations z</b>			1/h	10000	10000	10000	10000
<b>Mechanical life</b>			S x 10 <sup>6</sup>	10	10	10	50
<b>Utilization category AC15</b>							
Rated operational current $I_e$			220-240V A	4	4	12	4
			380-415V A	2	2	4	2
			440V A	1,6	1,6	4	1,6
			500V A	1,2	1,2	3	1,2
			660-690V A	0,6	0,6	1	0,6
<b>Utilization category DC13</b>							
Rated operational current $I_e$			24-60V A	3,5	3,5	8	3,5
per pole			110V A	0,5	0,5	1	0,5
			220V A	0,1	0,1	0,1	0,1
<b>Power consumption of coils</b>							
AC operated			inrush VA	30 - 45	-	-	-
			sealed VA	7 - 10	-	-	-
			W	2,6 - 3	-	-	-
DC operated			inrush W	-	75	3	3
			sealed W	-	2	3	3
<b>Operation range of coils</b>							
in multiples of control voltage $U_s$				0,85 - 1,1	0,8 - 1,1	0,8 - 1,1	0,8 - 1,1
<b>Switching time</b> at control voltage $U_s \pm 10\%$							
make time			ms	8 - 16	8 - 16	65 - 85	65 - 85
release time			ms	5 - 13	5 - 13	20 - 30 <sup>3)</sup>	20 - 30 <sup>3)</sup>
<b>Maximum ambient temperature</b>							
Operation			open °C	-40 to +60 (+90) <sup>2)</sup>			
			enclosed °C	-40 to +40			
Storage			°C	-40 to +90			
<b>Short circuit protection</b>							
short-circuit current 1kA, contact welding not accepted							
max. fuse size			gL (gG) A	20	20	25	20
<b>Cable cross-section</b>							
Connector			solid mm <sup>2</sup>	0,75 - 6			
			flexible mm <sup>2</sup>	1 - 4			
			flexible with multicore cable end mm <sup>2</sup>	0,75 - 4			
Magnet coil			solid mm <sup>2</sup>	0,75 - 2,5			
			flexible mm <sup>2</sup>	0,75 - 2,5			
			flexible with multicore cable end mm <sup>2</sup>	0,5 - 1,5			
Clamps per pole				2			
Connector			solid AWG	18 - 10			
			flexible AWG	18 - 10			
Clamps per pole				2			
Magnet coil			solid AWG	14 - 12			
			flexible AWG	18 - 12			
Clamps per pole				2			

## Data according to UL508

Rated operational current "General Use"			A	10	10	20	10
Rated operational voltage			max. V AC	600	600	600	600
<b>Auxiliary Contacts</b>			heavy pilot duty	A600	A600	A600	A600

1) Suitable at 690V for: earthed-neutral systems, overvoltage category I to IV, pollution degree 3 (standard-industry):  $U_{imp} = 8kV$ .  
Data for other conditions on request.

2) With reduced control voltage range 0,9 up to 1,0 x  $U_s$  and with reduced thermal rated current  $I_{th}$  according to  $I_e/AC15$

3) with built-in coil suppressor

# Contactor Relays

## Position of Terminals

AC operated

**K3-07ND22**

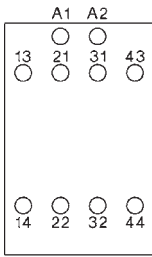

**K3-07ND31**

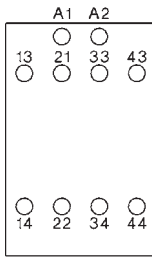

**K3-07ND40**

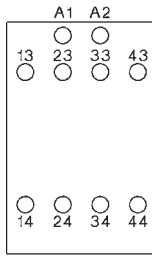

**K3-07ND04**

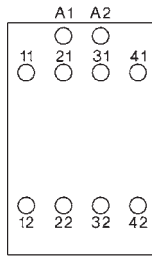

DC operated with double wound coil

**K3-07ND22=**

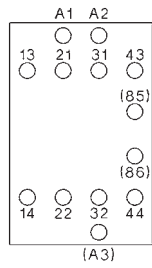

**K3-07ND31=**

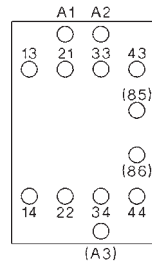

**K3-07ND40=**

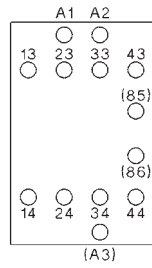

**K3-07ND04=**

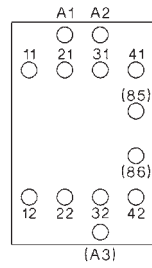

DC solenoid operated

**KG3-07A22**  
**KG3-07D22**

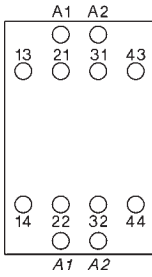

**KG3-07A31**  
**KG3-07D31**

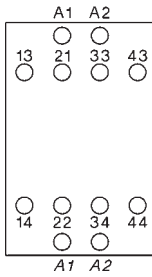

**KG3-07A40**  
**KG3-07D40**

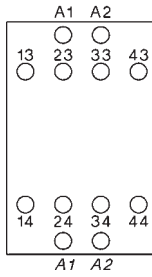

**KG3-07A04**  
**KG3-07D04**

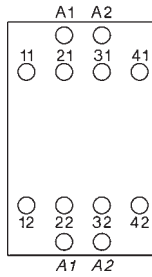

# Contactors Relays

## Dimensions

AC operated

K3-07ND..

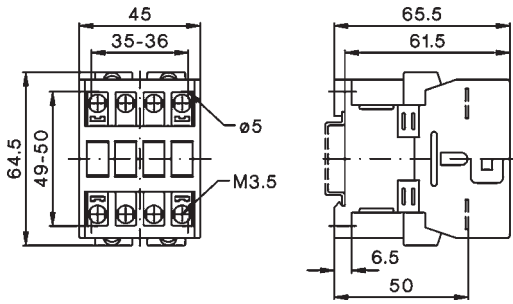

DC solenoid operated

KG3-07..

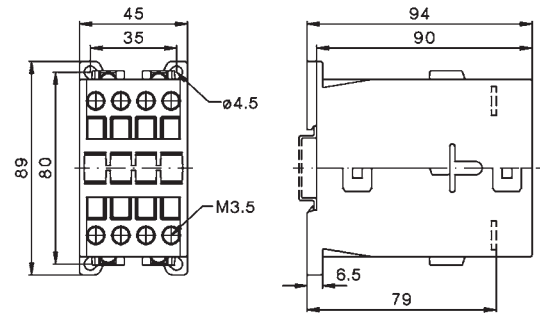

DC operated with double winding coil

K3-07ND.. =

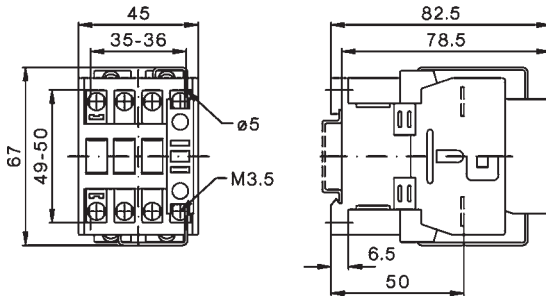





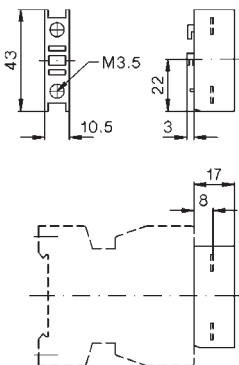



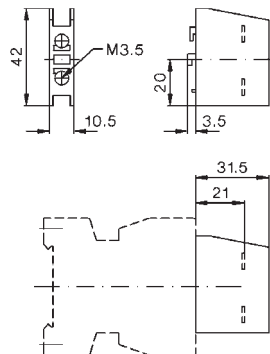







Auxiliary contact blocks

HN10, HN01

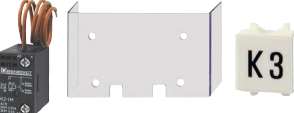

HA10, HA01



	Contactor overview	46
	Contactors 3-pole, AC Operated	48
	Contactors 3-pole, DC Operated	49
	Contactors 4-pole	50
	Capacitor Switching Contactors	51
	Auxiliary Contact Blocks Snap-on Momentary Contacts Additional Fourth Poles for Contactors	52
	Pneumatic Timers Electronic Timers On-delay Electronic Timers Off-delay	53
	Mechanical Interlocks Latches Additional Terminals, Parallel Connectors	54
	Indicator Units Fuse Holders Suppressor Units	55
	Interface Terminal Covers Mounting Parts	56
	Control Voltages	57
	Spare Coils AC-operated Feeder Groups	58
	Spare Coils DC-operated Spare Contacts	59
	Technical Data	62
	Dimensions	82

# Contactors 3-pole

- Up to 1200A AC3
- Up to 1350A AC1
- DIN-rail mounting up to AC3 115A
- International Approvals
- Data according to IEC 947 / EN 60947



Ratings		10A	14A	18A	22A	24A	32A	40A	50A	62A	74A	90A	115A
AC3 400V	Motor	4kW	5,5kW	7,5kW	11kW	11kW	15kW	18,5kW	22kW	30kW	37kW	45kW	55kW
	380-400V 660-690V	5,5kW	7,5kW	10kW	10kW	15kW	18,5kW	18,5kW	30kW	37kW	45kW	55kW	55kW
AC1 690V at 40°C		25A	25A	32A	32A	50A	65A	80A	110A	120A	130A	160A	200A
Type	K3-	10ND10	14ND10	18ND10	22ND10	24A00	32A00	40A00	50A00	62A00	74A00	90A00	115A00
Auxiliary contacts		1NO	1NO	1NO	1NO	-	-	-	-	-	-	-	-
Type	K3-	10ND01	14ND01	18ND01	22ND01								
Auxiliary contacts		1NC	1NC	1NC	1NC								
Cable cross-section													
Solid	mm <sup>2</sup>		0,75 - 6				1,5 - 25			4 - 50		10 - 120	
Flexible	mm <sup>2</sup>		1 - 4				2,5 - 16			10 - 35		10 - 95	
Auxiliary contact													
I <sub>th</sub> 40°C	A		10				-			-		-	
AC15 230V	A		3				-			-		-	
400V	A		2				-			-		-	
Power consumption													
Inrush VA			33 - 45				90 - 115			140 - 165		280	
of coils hold VA			7 - 10				9 - 13			13 - 18		5	
Operation range of coils			0,85 - 1,1				0,85 - 1,1			0,85 - 1,1		0,85 - 1,1	
Mounting		35mm DIN-rail or base										2x DIN-rail or base	
Additional aux. contact blocks													
Front mounting contacts	Type	HN10 1NO f. low level switching	HN01 1NC f. low level switching	HA10 1NO 25A I <sub>th</sub>	HA01 1NC 25A I <sub>th</sub>	max. 4 HN.. or 4 HA..		max. 7 HN.. or 7 HA..					
Additional aux. contact blocks													
Side mounting contacts	Type	-	-	-	-	HB11 1NO+1NC f. low level switching	HB02 2NC f. low level switching	max. 2 HB..					
Overload Relay (thermal)													
Single phase protection													
Temperature compensation		U3/32		U3/42		U3/74		U85					
Trip and alarm contacts		U12/16..K3		U3/42		U3/74		U85					
Type		U3/32		U3/42		U3/74		U85					
Number of Setting Ranges from		16 0,12 - 30A	16 0,12 - 32A	4 10 - 42A	5 20 - 74A	2 60 - 120A							
Busbar sets		-	-	-	-	-							

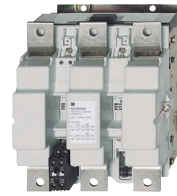

Contactor, Motor-Starter

Circuit Breakers

Manual Motor-Starters







Switches

AC-Main Switches

DC-Switch Disconnect









Push Buttons

Representatives, Suppliers

<b>150A</b>	<b>175A</b>	<b>210A</b>	<b>260A</b>	<b>315A</b>	<b>450A</b>	<b>550A</b>	<b>700A</b>	<b>860A</b>	<b>1000A</b>	<b>1200A</b>		
<b>75kW</b> 90kW	<b>90kW</b> 110kW	<b>110kW</b> 160kW	<b>132kW</b> 210kW	<b>160kW</b> 250kW	<b>250kW</b> 375kW	<b>300kW</b> 475kW	<b>400kW</b> 630kW	<b>500kW</b> 700kW	<b>580kW</b> 850kW	<b>680kW</b> 1000kW		
250A	300A	350A	450A	600A	700A	800A	1000A	1100A	1200A	1350A		
<b>151A00</b>	<b>176A00</b>	<b>210A00</b>	<b>260A00</b>	<b>316A00</b>	<b>450A22</b>	<b>550A22</b>	<b>700A22</b>	<b>860A22</b>	<b>1000A12</b>	<b>1200A12</b>		
-	-	-	-	-	2NO+2NC	2NO+2NC	2NO+2NC	2NO+2NC	1NO+2NC	1NO+2NC		
2 x 16-120 2 x 16-120		busbar 30x6	busbar 30x6	busbar 30x6	busbar 30x5	busbar 40x6	busbar 50x8	busbar 50x8	busbar 50x10	busbar 50x10		
- - -		-	-	-		10 3 2			10 3 2			
350 5 0,85 - 1,1	350 5	360 5	360 5 0,85 - 1,1	360 5	800-950 9-11	800-950 9-11	1350-1600 21-25 0,85 - 1,1	1350-1600 21-25	2400 70 0,85-1,1	2400 70		
base												
	<b>HKT11 HKT22</b> 1NO+1NC 2NO+2NC max. 1 pc.					<b>HKF22</b> 2NO+2NC max. 1 pc.			<b>HKB11</b> 1NO+1NC max. 2 pcs.			
	<b>HKA11</b> 1NO+1NC max. 2 pcs.				-	-	-	-	-	-		
	<b>U180</b>  1 120 - 180A  integrated					<b>U320</b>  2 144 - 320A  integrated					<b>U800</b>  3 240 - 800A  SU840/550   SU840/860	

# Contactors 3-pole

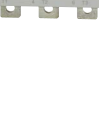
## AC Operated

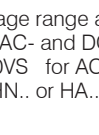
Ratings		Rated Current	Aux. Contacts		Type	Coil voltage <sup>1)</sup>	Pack pcs.	Weight kg/pc.
AC2, AC3			Built-in	Additional see page 52				
380V								
400V	660V	AC1			Typ	24		
415V	690V	690V				110		
kW	kW	A	NO	NC	Typ	230		
						400		
								
<b>4</b>	5,5	25	1	-	max. 4		1	0,23
<b>4</b>	5,5	25	-	1	HN.. or HA..		1	0,23
<b>5,5</b>	7,5	25	1	-			1	0,23
<b>5,5</b>	7,5	25	-	1			1	0,23
<b>7,5</b>	10	32	1	-			1	0,23
<b>7,5</b>	10	32	-	1			1	0,23
<b>11</b>	10	32	1	-			1	0,23
<b>11</b>	10	32	-	1			1	0,23
								
<b>11</b>	15	50	-	-	max. 4		1	0,48
<b>15</b>	18,5	65	-	-	HN.. or HA..		1	0,48
<b>18,5</b>	18,5	80	-	-	HA.. and 2HB..		1	0,48
								
<b>22</b>	30	110	-	-	max. 4 (3) <sup>4)</sup>		1	0,85
<b>30</b>	37	120	-	-	HN.. or HA..		1	0,85
<b>37</b>	45	130	-	-	HA.. and 2HB..		1	0,85
								
<b>45</b>	55	160	-	-	max. 7		1	2,2
<b>55</b>	55	200	-	-	HN.. or HA.. and 2HB..		1	2,2
								
<b>75</b>	110	250	-	-	1 HKT..		1	4
<b>90</b>	132	300	-	-	and 2 HKA11		1	4
								
<b>110</b>	160	350	-	-			1	7,2
<b>132</b>	210	450	-	-			1	7,2
<b>160</b>	250	600	-	-			1	7,2
								
<b>250</b>	375	700	2	2	1 HKF22		1	13
<b>300</b>	475	800	2	2			1	13,5
								
<b>400</b>	630	1000	2	2			1	26,5
<b>500</b>	700	1100	2	2			1	27,6
								
<b>580</b>	850	1200	1	2	2 HKB11		1	49
<b>680</b>	1000	1350	1	2			1	53







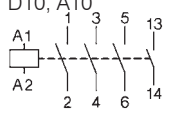
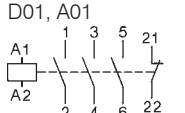

1) Coil voltage range and other coil voltages see page 57

2) Type for AC- and DC-operating: e.g.: 230: 220-240V 50/60Hz and 220V DC (with integrated coil suppressor)

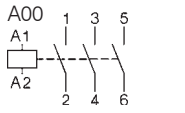
3) Type 230VS for AC-operating 220-240V 50Hz (with integrated coil suppressor)

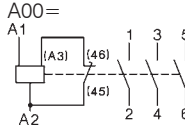
4) max. 3 HN.. or HA.. for DC-operated Contactors.

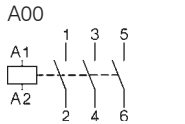
# DC Operated

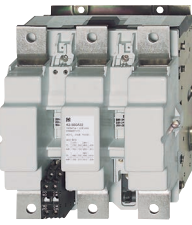
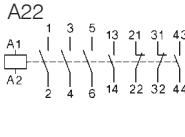
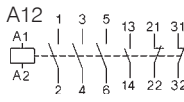
Type	Coil voltage <sup>1)</sup>		Coil power	Additional Overload Relay see page 114	Wiring Diagram	Pack pcs.	Weight kg/pc.
	24	48					
	24	48	inrush/hold				
	110	110					
	220	110					
	↓						
	<b>KG3-10A10</b> ... <sup>5)</sup>		3/3	U3/32	D10, A10	1	0,53
	<b>KG3-10A01</b> ... <sup>5)</sup>		3/3	U12/16E U12/16EQ		1	0,53
	<b>KG3-14A10</b> ... <sup>5)</sup>		3/3	UAT21	D01, A01	1	0,53
	<b>KG3-14A01</b> ... <sup>5)</sup>		3/3			1	0,53
	<b>KG3-18A10</b> ... <sup>5)</sup>		3/3			1	0,53
	<b>KG3-18A01</b> ... <sup>5)</sup>		3/3			1	0,53
	<b>KG3-22A10</b> ... <sup>5)</sup>		3/3			1	0,53
	<b>KG3-22A01</b> ... <sup>5)</sup>		3/3			1	0,53
	<b>KG3-24A00</b> ... <sup>5)</sup>		4/4	U3/32	A00	1	0,57
	<b>KG3-32A00</b> ... <sup>5)</sup>		4/4	U3/42		1	0,57
	<b>KG3-40A00</b> ... <sup>5)</sup>		4/4	UAT..		1	0,57
	<b>K3-50A00=</b> ...		200/6	U3/74	A00=	1	0,9
	<b>K3-62A00=</b> ...		200/6			1	0,9
	<b>K3-74A00=</b> ...		200/6			1	0,9
	<b>K3-90A00</b> ... <sup>2)</sup>		280/5	U85	A00	1	2,2
	<b>K3-115A00</b> ... <sup>2)</sup>		280/5			1	2,3
	<b>K3-151A00</b> ... <sup>2)</sup>		350/5	U180		1	4
	<b>K3-176A00</b> ... <sup>2)</sup>		350/5			1	4
	<b>K3-210A00</b> ... <sup>2)</sup>		360/5	U320		1	7,2
	<b>K3-260A00</b> ... <sup>2)</sup>		360/5			1	7,2
	<b>K3-316A00</b> ... <sup>2)</sup>		360/5			1	7,2
	<b>K3-450A22</b> ... <sup>2)</sup>		800/10	U800	A22	1	13
	<b>K3-550A22</b> ... <sup>2)</sup>		800/10	+SU840/550		1	13,5
	<b>K3-700A22</b> ... <sup>2)</sup>		1500/20	U800		1	26,5
	<b>K3-860A22</b> ... <sup>2)</sup>		1500/20	+SU840/860		1	27,6
	<b>K3-1000A12=</b> ...		2100/60		A12	1	49
	<b>K3-1200A12=</b> ...		2100/60			1	53

1) Other coil voltages on request

2) Type for AC- and DC-operating: e.g.: 24: 24V 50/60Hz and 24V DC (with integrated coil suppressor)

5) with integrated coil suppressor



## Contactors 3-pole

DC Operated with double winding coil



Ratings		Rated Current	Aux. Contacts		Type	Coil voltage <sup>1)</sup>	Pack pcs.	Weight kg/pc.
AC2	AC3		Built-in	Additional see page 52				
<b>380V</b>		AC1				<b>24</b> 24V= DC		
<b>400V</b>	660V	690V	NO	NC	Type	<b>48</b> 48V= DC		
<b>415V</b>	690V					<b>110</b> 110V= DC		
<b>kW</b>	<b>kW</b>	<b>A</b>				<b>220</b> 220V= DC		
<b>4</b>	5,5	25	1	-	max. 3	<b>K3-10ND10= ...</b>	1	0,25
<b>4</b>	5,5	25	-	1	HN..	<b>K3-10ND01= ...</b>	1	0,25
<b>5,5</b>	7,5	25	1	-	HA..	<b>K3-14ND10= ...</b>	1	0,25
<b>5,5</b>	7,5	25	-	1		<b>K3-14ND01= ...</b>	1	0,25
<b>7,5</b>	10	32	1	-		<b>K3-18ND10= ...</b>	1	0,25
<b>7,5</b>	10	32	-	1		<b>K3-18ND01= ...</b>	1	0,25
<b>11</b>	10	32	1	-		<b>K3-22ND10= ...</b>	1	0,25
<b>11</b>	10	32	-	1		<b>K3-22ND01= ...</b>	1	0,25
<b>11</b>	15	50	-	-	max. 4	<b>K3-24A00= ...</b>	1	0,55
<b>15</b>	18,5	65	-	-	HN.. or	<b>K3-32A00= ...</b>	1	0,55
<b>18,5</b>	18,5	80	-	-	HA.. + 2HB..	<b>K3-40A00= ...</b>	1	0,55

Wiring Diagram

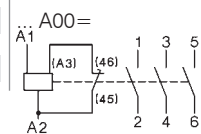
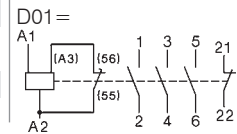
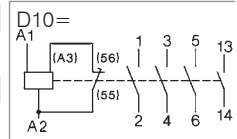

## Contactors 4-pole

AC or DC Operated



Ratings		Rated Current	Aux. Contacts		Type	Coil voltage <sup>2)</sup>	Pack pcs.	Weight kg/pc.
AC2	AC1		Built-in	Additional see page 52				
<b>380V</b>		AC1				<b>24</b> 24V 50/60Hz		
<b>400V</b>		690V	NO	NC	Type	<b>110</b> 110V 50/60Hz		
<b>415V</b>	<b>400V</b>					<b>230</b> 220-240V 50Hz		
<b>kW</b>	<b>kW</b>	<b>A</b>				<b>400</b> 380-415V 50Hz		
<b>4</b>	<b>17,5</b>	25	-	-	max. 4 <sup>3)</sup>	<b>= 24</b> 24V= DC <sup>3)</sup>		
<b>4</b>	<b>17,5</b>	25	-	-	HN.. or	<b>K3-10NA00-40 ...<sup>3)</sup></b>	1	0,23
<b>4</b>	<b>17,5</b>	25	-	-	HA..	<b>K3-10NA00-22 ...<sup>3)</sup></b>	1	0,23
						<b>K3-10NA00-04 ...<sup>3)</sup></b>	1	0,23
<b>5,5</b>	<b>17,5</b>	25	-	-		<b>K3-14NA00-40 ...<sup>3)</sup></b>	1	0,23
<b>5,5</b>	<b>17,5</b>	25	-	-		<b>K3-14NA00-22 ...<sup>3)</sup></b>	1	0,23
<b>5,5</b>	<b>17,5</b>	25	-	-		<b>K3-14NA00-04 ...<sup>3)</sup></b>	1	0,23
<b>7,5</b>	<b>22</b>	32	-	-		<b>K3-18NA00-40 ...<sup>3)</sup></b>	1	0,23
<b>7,5</b>	<b>22</b>	32	-	-		<b>K3-18NA00-22 ...<sup>3)</sup></b>	1	0,23
<b>7,5</b>	<b>22</b>	32	-	-		<b>K3-18NA00-04 ...<sup>3)</sup></b>	1	0,23
<b>11</b>	<b>22</b>	32	-	-		<b>K3-22NA00-40 ...<sup>3)</sup></b>	1	0,23
<b>11</b>	<b>31</b>	45	-	-	max. 4	<b>K2-23A00-40 ...<sup>3)</sup></b>	1	0,65
<b>15</b>	<b>34,5</b>	50	-	-	HN..	<b>K2-30A00-40 ...<sup>3)</sup></b>	1	0,65
<b>18,5</b>	<b>34,5</b>	50	-	-	or HA..	<b>K2-37A00-40 ...<sup>3)</sup></b>	1	0,65
<b>22</b>	<b>55</b>	80	-	-	max. 6	<b>K2-45A00-40 ...<sup>3)</sup></b>	1	1,1
<b>30</b>	<b>69</b>	100	-	-	HN.. or HA..	<b>K2-60A00-40 ...<sup>3)</sup></b>	1	1,1
<b>15</b>	<b>43</b>	63	-	-	1HKT..	<b>K3-41A00-04 ...<sup>3)</sup></b>	1	1,4
<b>15</b>	<b>43</b>	63	-	-	+ 2xHKA11	<b>K3-41A00-22 ...<sup>3)</sup></b>	1	1,4
<b>30</b>	<b>85</b>	125	-	-		<b>K3-96A00-04 ...<sup>4)</sup></b>	1	2,42
<b>30</b>	<b>85</b>	125	-	-		<b>K3-96A00-22 ...<sup>4)</sup></b>	1	2,42
<b>45</b>	<b>94</b>	135	-	-		<b>K3-96A00-40 ...<sup>4)</sup></b>	1	2,42
<b>55</b>	<b>139</b>	200	-	-		<b>K3-116A00-40 ...<sup>4)</sup></b>	1	4,7
<b>75</b>	<b>173</b>	250	-	-		<b>K3-151A00-40 ...<sup>4)</sup></b>	1	4,7
<b>90</b>	<b>208</b>	300	-	-		<b>K3-176A00-40 ...<sup>4)</sup></b>	1	4,7
<b>110</b>	<b>242</b>	350	-	-		<b>K3-210A00-40 ...<sup>4)</sup></b>	1	8
<b>132</b>	<b>310</b>	450	-	-		<b>K3-260A00-40 ...<sup>4)</sup></b>	1	8
<b>160</b>	<b>415</b>	600	-	-		<b>K3-316A00-40 ...<sup>4)</sup></b>	1	8

Wiring Diagram

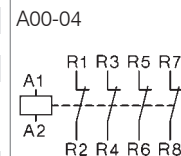
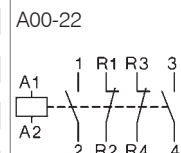
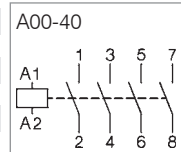

Latch for Contactors 4-pole see page 54

1) Other coil voltages on request

2) Coil voltage range and non-standard coil voltages see page 57

3) DC Operated with double winding coil, max. 3 additional aux. contacts

4) with integrated coil suppressor (AC/DC coil)

# Capacitor Switching Contactors

for use with reactive or non-reactive capacitor banks



### Rated Operational Power at 50/60Hz

Ambient Temperature

50°C		60°C	
<b>380V</b>	415V	660V	380V
<b>400V</b>	440V	690V	400V
<b>kVAr</b>	kVAr	kVAr	kVAr

Aux. Contacts  
Built-in Add.  
NO NC pcs.

### Type

Coil voltage <sup>1)</sup>  
220-240V 50Hz

230

Pack Weight  
pcs. kg/pc.

0-12,5	0-13	0-20	0-12,5	0-13	0-20	1	-	1 <sup>2)</sup>	<b>K3-18NK10</b> ...	1	0,34
0-12,5	0-13	0-20	0-12,5	0-13	0-20	-	1	1 <sup>2)</sup>	<b>K3-18NK01</b> ...	1	0,34
0-12,5	0-13	0-20	0-12,5	0-13	0-20	1	-	1 <sup>2)</sup>	<b>K3-18NBK10</b> ...	1	0,40
0-12,5	0-13	0-20	0-12,5	0-13	0-20	-	1	1 <sup>2)</sup>	<b>K3-18NBK01</b> ...	1	0,40
10-20	10,5-22	17-33	10-20	10,5-22	17-33	-	-	3 <sup>3)</sup>	<b>K3-24K00</b> ...	1	0,62
10-25	10,5-27	17-41	10-25	10,5-27	17-41	-	-	3 <sup>3)</sup>	<b>K3-32K00</b> ...	1	0,62
20-33,3	23-36	36-55	20-33,3	23-36	36-55	-	-	3 <sup>3)</sup>	<b>K3-50K00</b> ...	1	1,0
20-50	23-53	36-82	20-50	23-53	36-82	-	-	3 <sup>3)</sup>	<b>K3-62K00</b> ...	1	1,0
20-75 <sup>4)</sup>	23-75 <sup>4)</sup>	36-120 <sup>4)</sup>	20-60	23-64	36-100	-	-	3 <sup>3)</sup>	<b>K3-74K00</b> ...	1	1,0
33-80	36-82	57-120	33-75	36-77	57-120	-	-	6 <sup>5)</sup>	<b>K3-90K00</b> ... / VS <sup>7)</sup>	1	2,3
33-100 <sup>6)</sup>	36-103 <sup>6)</sup>	57-148 <sup>6)</sup>	33-90 <sup>6)</sup>	36-93 <sup>6)</sup>	57-148 <sup>6)</sup>	-	-	6 <sup>5)</sup>	<b>K3-115K00</b> ... / VS <sup>7)</sup>	1	2,3

**Specification:** Contactors K3-..K are suitable for switching low-inductive and low loss capacitors in capacitor banks (IEC70 and 831, VDE 0560) without and with reactors.

Capacitor switching contactors are fitted with early make contacts and damping resistors, to reduce the value of make current <math><70 \times I\_g</math>.

**Operating Conditions:** Capacitor switching contactors are protected against contact welding for a prospective making current of  $200 \times I_g$ .

## Technical Data acc. to IEC 947-4-1, IEC 947-5-1, EN 60947-4-1, EN 60947-5-1, VDE 0660

Type		K3-18NK	K3-18NBK <sup>8)</sup>	K3-24K	K3-32K	K3-50K	K3-62K	K3-74K	K3-90K	K3-115K
Max. frequency of operations z	1/h	120	120	120	120	120	120	80	80	80
Contact life non reactive cap. banks	S x 10 <sup>3</sup>	250	250	150	150	150	150	120	120	120
	reactive cap. banks S x 10 <sup>3</sup>	400	400	300	300	300	300	200	200	200
<b>Rated operational current I<sub>o</sub></b> <b>AC6b</b>	at 50°C A	<b>0-18</b>	<b>0-18</b>	<b>14-28</b>	<b>14-36</b>	<b>30-48</b>	<b>30-72</b>	<b>30-108</b>	<b>50-115</b>	<b>50-144</b>
	at 60°C A	<b>0-18</b>	<b>0-18</b>	<b>14-28</b>	<b>14-36</b>	<b>30-48</b>	<b>30-72</b>	<b>30-87</b>	<b>50-108</b>	<b>50-130</b>
Rated operational current I <sub>th</sub> AC1	at 50°C A	32	45	45	60	100	110	120	155	190
	at 60°C A	32	40	40	55	90	100	110	145	170
Overload factor acc. to EN 61921: 30% min.	at 50°C %	78	150	60	67	108	53	11	35	32
	at 60°C %	78	122	43	53	88	39	26	34	31
Fuses gL (gG)	from / to A	35 / 63	35 / 63	50 / 80	63 / 100	80 / 160	125 / 160	160/200	160/200	160/250

### Typical Circuit Diagram

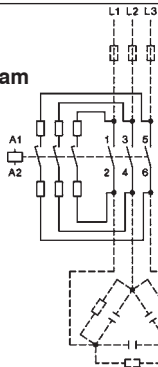

### Wiring Diagram for Quick Discharge Resistors

Make sure that the current of the discharge resistors is not higher than the rated current (AC1) of the auxiliary contacts

### Mounting instructions:

In the area of capacitor switching contactors, difficulty inflammable and self-extinguishing materials shall be used only, because abnormal temperatures within the area of the resistor spirals cannot be excluded.

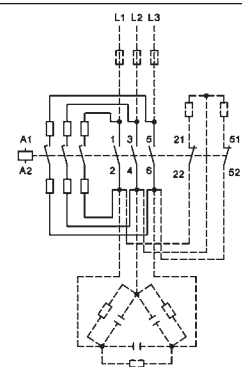

- 1) Coil voltage range and non-standard coil voltages see page 57
- 2) 1 HN.. or HA.. snap-on
- 3) 2HB.. for side mounting and 1 HN.. or HA.. snap-on
- 4) Consider the max. thermal current of the contactor K3-74A: I<sub>th</sub> 130A
- 5) 2 HB.. on the left or right side and 4 HN.. or HA.. snap-on
- 6) Consider the min. cross-section of conductor at max. load
- 7) Type 230 for AC- and DC-operating 220-240V 50/60Hz and 220V DC (with integrated coil suppressor)  
Type 230VS for AC-operating 220-240V 50Hz (with integrated coil suppressor)
- 8) Cable cross sections: 2,5 - 16mm<sup>2</sup>

## Auxiliary Contact Blocks for contactors K(G)3-07.. to K3-115.., type HN.. for low level switching <sup>1)</sup>



Rated Operational Current			Contacts				Type	Pack pcs.	Weight kg/pc.
AC15 230V A	AC15 400V A	AC1 690V A	NO	NC	EM	LB			
3	2	10	1	-	-	-	<b>HN10</b>	10	0,02
3	2	10	-	1	-	-	<b>HN01</b>	10	0,02
3	2	10	-	-	1	-	<b>HN10U</b>	10	0,02
3	2	10	-	-	-	1	<b>HN01U</b>	10	0,02
6	3	25	1	-	-	-	<b>HA10</b>	10	0,03
6	3	25	-	1	-	-	<b>HA01</b>	10	0,03

## Auxiliary Contact Block for contactors K3-24.. to K3-115.., for low level switching <sup>1)</sup>



Rated Operational Current			mounting: 1 HB.. on left side and 1 HB.. on right side	Contacts		Type	Pack pcs.	Weight kg/pc.
AC15 230V A	AC15 400V A	AC1 690V A		NO	NC			
3	2	10		1	1	<b>HB11</b>	10	0,02
3	2	10		-	2	<b>HB02</b>	10	0,02

## Auxiliary Contact Blocks for contactors K3-116.. to K3-1200.., for low level switching <sup>1)</sup>



Rated Operational Current			For contactors	Contacts		Type	Pack pcs.	Weight kg/pc.
AC15 230V A	AC15 400V A	AC1 690V A		NO	NC			
3	2	10	K3-116 to K3-316 top	1	1	<b>HKT11</b>	1	0,04
3	2	10	K3-116 to K3-316 top	2	2	<b>HKT22</b>	1	0,05
3	2	10	K3-116 to K3-316 outside	1	1	<b>HKA11</b>	1	0,05
6	3	16	K3-200 to K3-860 <sup>2)</sup>	2 <sup>2)</sup>	2	<b>HKF22</b>	1	0,12
6	3	16	K3-1000, K3-1200 inside	1	1	<b>HKB11</b>	1	0,17

## Snap-on Momentary Contacts for K(G)3-07.. to K3-115.. for low level switching <sup>1)</sup>



Rated Operational Current			Specification	Contacts		Type	Pack pcs.	Weight kg/pc.
AC15 230V A	AC15 400V A	AC1 690V A		NO	NC			
3	2	10	manual operated	1	-	<b>HTN10</b>	10	0,02
3	2	10	manual operated	-	1	<b>HTN01</b>	10	0,02

## Terminal Blocks for contactors K(G)3-07.. to K3-115.. and K2-..



Specification	Thermal Current I <sub>th</sub> A	Type	Pack pcs.	Weight kg/pc.
2 terminals interconnected	26	<b>K2-DK</b>	10	0,02
2 terminals insulated	26	<b>K2-SK</b>	10	0,02

1) Contacts suitable for electronic circuits, according to IEC60947-5-4 for rated voltage 24V DC (test ratings 17V DC, 5mA) Mirror contacts acc. IEC60947-4-1 Annex F. Technical data see page 80

2) Contact travel of make contacts adjustable, see page 81

# Electronic Timer

for mounting on DIN-rail, Control voltage 24-240V AC/DC, 1 changeover contact  
 OFF-delay without auxiliary voltage  
 Replace Pneumatic Timer K2-TP. and K2-TA



5 Functions in one device	4 Time ranges in one device s	Rated Current AC1 250V A	Type	Pack pcs.	Weight kg/pc.
ON-delay, OFF-delay, Single shot trailing edge, Single shot leading edge, Single shot leading and trailing edge	0,1 - 1, 1 - 10, 6 - 60 a. 18 - 180	5	<b>K3-T180 240</b>	1	0,085

## Electronic Timer On-delay for contactors K(G)3-07.. to K3-115.. and K2-..

Timer will be connected with the contactor coil, can be snapped onto the contactor and occupies 2 add-on spaces. Contactor switches On-delay.



Operational Voltage V	Time Range s	Rated Current AC15 A	Type	Pack pcs.	Weight kg/pc.
24 - 60V AC/DC	1 - 30	0,75	<b>K2-TE30 60</b>	1	0,08
100 - 250V AC/DC	1 - 30	0,75	<b>K2-TE30 250</b>	1	0,08
24 - 60V AC/DC	10 - 180	0,75	<b>K2-TE180 60</b>	1	0,08
100 - 250V AC/DC	10 - 180	0,75	<b>K2-TE180 250</b>	1	0,08
24 - 60V AC/DC	30 - 600	0,75	<b>K2-TE600 60</b>	1	0,08
100 - 250V AC/DC	30 - 600	0,75	<b>K2-TE600 250</b>	1	0,08

### Wiring Diagram

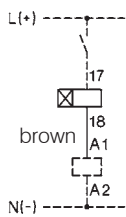

### Timing Chart

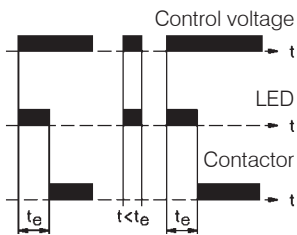

### Operation Range

Time repeat accuracy  
 Recovery time (typical)

$0,8 - 1,1 \times U_s$   
 $\leq 1\%$   
 50ms

**Voltage Drop** after the time delay  $t_e$   
 (Control voltage 24V: use contactor with 20V-coil)  
 Max. inrush current (peak value)

<3V  
 25A <10ms

### Duty Cycle

Ambient temperature  
 Short circuit protection

100%  
 $-40^\circ - +60^\circ\text{C}$   
 2A

## Interface for contactors K3-07.. to K3-74.. and K2-07.. to K2-60..



Input Voltage $U_e$	Power Consumption	Rated Current $I_e$	AC15 250V AC	400V AC	Type	Pack pcs.	Weight kg/pc.
24V DC	0,35W	0,75A	0,5A		<b>K2-IM</b>	1	0,03

Amplifier element for contactor control by programmable controller

## Fuse Holders for contactors K(G)3-07.. to K3-115.. and K2-..



Specifications	Rated Voltage	Type	Pack pcs.	Weight kg/pc.
Fuse holder for fuse 5x20mm (max. 6,3A) Fuses are not included.	250V AC	<b>K2-F</b>	1	0,02

## Rectifier with Fuse Holder for contactors K(G)3-07.. to K3-115.. and K2-..

Specifications	Rated Voltage	Type	Pack pcs.	Weight kg/pc.
with built-in rectifier 1A	250V AC	<b>K2-RF1</b>	1	0,03
with built-in rectifier 3A	250V AC	<b>K2-RF3</b>	1	0,03

## Latch for contactors K(G)3-07.. to K3-74.. and K2-..

with NC aux. contact  
duty cycle 10%, max. 30 sec. AC / max. 20 sec. DC  
power consumption max. 30VA

Type	Coil voltage
<b>24</b>	22-26V 50/60Hz
<b>110</b>	100-120V 50/60Hz
<b>230</b>	210 -250V 50/60Hz
<b>400</b>	360-440V 50/60Hz

For Contactors

For Contactors	Type	Pack pcs.	Weight kg/pc.
K3-07 to K3-22, K2-07 to K2-16	<b>K2-L22 . . .</b>	1	0,08
K3-24 to K3-40, K2-23 to K2-37, KG3-10 to KG3-40	<b>K2-L40 . . .</b>	1	0,08
K3-50 to K3-74, K2-45 to K2-60	<b>K2-L74 . . .</b>	1	0,08

Technical data see page 74

**Latch / Magnetic latch for Contactors K3-151 to K3-1200 on request**

## Indicator Units for contactors K(G)3-07.. to K3-115.. and K2-..



Specifications	Voltage Range	Type	Pack pcs.	Weight kg/pc.
<b>Coil Current Indicator</b> , green (LED)	24 - 660V AC/DC	<b>K2-ING</b>	10	0,02
<b>Coil Current Indicator</b> , red (LED)	24 - 660V AC/DC	<b>K2-INR</b>	10	0,02
To connect in series with the contactor coil. In case of coil interruption the indication goes out. Voltage drop appr. 2 volts				
<b>Voltage Indicator</b> , clear (glow-disc. I.)	220 - 415V AC/DC	<b>K2-UN</b>	10	0,02
<b>Voltage Indicator</b> , red (LED)	24 - 120V AC/DC	<b>K2-UNR</b>	10	0,02
To connect parallel to the contactor coil. In case of applied voltage the indication also lights at coil interruption.				

## Snap-On Adapter



For Type	Specification	Type	Pack pcs.	Weight kg/pc.
K2-DK, K2-SK, K2-TE, K2-TA K2-IM, K2-F, K2-RF K2-IN., K2-UN.	for snap-on mounting of accessories on 35mm DIN-rail acc. DIN EN 50022	<b>K2-SM</b>	10	0,009

## Additional 4<sup>th</sup> Poles for contactors K3-315.. to K3-1200



For Contactors	Thermal Current $I_{th}$ A	Type	Pack pcs.	Weight kg/pc.
K3-315, K3-450, K3-550	<b>325</b>	<b>NP325</b>	1	0,7
K3-315, K3-450, K3-550	<b>500</b>	<b>NP500</b>	1	1,3
K3-450, K3-550	<b>760</b>	<b>NP760</b>	1	1,4
K3-700, K3-860	<b>500</b>	<b>NP501</b>	1	1,3
K3-700, K3-860	<b>1000</b>	<b>NP1000</b>	1	1,6
K3-1000, K3-1200	<b>1000</b>	<b>NP1001</b>	1	1,6

## Mechanical Interlocks



Interlocks contactor with contactor Type	Type	Mounting	Type	Pack pcs.	Weight kg/pc.
K3-07 to K3-40 KG3-07 to KG3-22 KG3-24 to KG3-40 K2-07 to K2-37	K3-07 to K3-40 KG3-07 to KG3-22 KG3-24 to KG3-40 K2-07 to K2-37	horizontal	<b>LG10889</b> <sup>1)</sup>	10	0,006
K3-24 to K3-74 K2-23 to K2-60	K3-50 to K3-74 K2-45 to K2-60	horizontal	<b>LG10890</b> <sup>1)</sup>	1	0,010
K3-90, K3-115	K3-90, K3-115	horizontal	<b>LG11478</b> <sup>1)</sup>	1	0,010
K65 to K110	K65 to K110	horizontal	<b>LG8511</b>	1	0,076
K3-116 to K3-316	K3-116 to K3-316	horizontal	<b>LG11223H</b>	1	0,06
K3-315 to K3-550	K3-315 to K3-550	horizontal	<b>LG10400H</b>	1	0,8
K3-315 to K3-550	K3-315 to K3-550	vertical	<b>LG10400V</b>	1	0,8
K3-450, K3-550	K3-700, K3-860	horizontal	<b>LG10399H</b>	1	1,6
K3-450, K3-550	K3-700, K3-860	vertical	<b>LG10399V</b>	1	0,9
K3-700, K3-860	K3-700, K3-860	horizontal	<b>LG10402H</b>	1	1,5
K3-700, K3-860	K3-700, K3-860	vertical	<b>LG10402V</b>	1	0,9
K3-700, K3-860	K3-1000, K3-1200	horizontal	<b>LG10401H</b>	1	1,9
K3-700, K3-860	K3-1000, K3-1200	vertical	<b>LG10401V</b>	1	1,6
K3-1000, K3-1200	K3-1000, K3-1200	horizontal	<b>LG10403H</b>	1	1,8
K3-1000, K3-1200	K3-1000, K3-1200	vertical	<b>LG10403V</b>	1	1,5

1) clamps for mounting incl.

## Terminal Covers for terminal protection according to DIN 57106, VBG 4

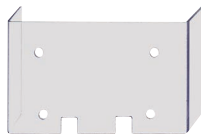

For Contactors	Specification	Type	Pack pcs.	Weight kg/pc.
K65 to K110 (spare part)	for 6 terminals	<b>LG9333</b>	1	0,045
K3-151, K3-176	3-pole for 3 terminals	<b>LG10404</b>	1	0,12
K3-116 to K3-176	4-pole for 4 terminals	<b>LG104044</b>	1	0,14
K3-210, K3-260, K3-316	for 3 terminals	<b>LG11457</b>	1	0,14
K3-200	for 3 terminals	<b>LG10405</b>	1	0,18
K3-315, K3-450	for 3 terminals	<b>LG10406</b>	1	0,28
K3-550	for 3 terminals	<b>LG10407</b>	1	0,34
K3-700	for 3 terminals	<b>LG10408</b>	1	0,39
K3-860	for 3 terminals	<b>LG10409</b>	1	0,49

## Additional Terminals



For Contactors	Cable Cross-sections to clamp mm <sup>2</sup> solid or stranded	flexible	flex. with multi- core cable end	Type	Pack pcs.	Weight kg/pc.
<b>Additional Terminal Single Pole, with fingertouch protection</b>						
K(G)3-10 to K(G)3-22	0,75 - 10	0,75 - 6	0,75 - 6	<b>LG9339N</b>	6	0,009
K2-09 to K2-16						
K3-151 to K3-176		16 - 120	+ 16 - 95	<b>LG11224</b>	1	0,10

1) Inclusively mounting clamps

## Parallel Connectors

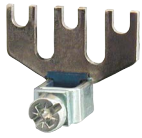

For Contactors	Cable Cross-sections to clamp mm <sup>2</sup> solid or stranded	flexible	flex. with multi- core cable end	Type	Pack pcs.	Weight kg/pc.
----------------	---	----------	-------------------------------------	------	--------------	------------------

### Parallel Connectors, 3 Poles Parallel

Current-carrying capacity: 2,5 x AC1-value of the contactor

K(G)3-10 to K(G)3-22	terminal hole for screw M5			<b>LG9241</b>	50	0,004
K2-09 to K2-16						
K2-23 to K2-37	4 - 35	6 - 25	4 - 25	<b>LG5587</b>	10	0,022

### Parallel Connectors, 4 Poles Parallel

Current-carrying capacity: 3,2 x AC1-value of the contactor

K(G)3-10 to K(G)3-22	terminal hole for screw M5			<b>LG7360</b>	10	0,006
K2-09 to K2-16						

## Suppressor Units



Voltage Range V	Mounting	Type	Pack pcs.	Weight kg/pc.
--------------------	----------	------	--------------	------------------

### RC-units for contactors K3-07 - K3-74

12 - 48V AC/DC	to snap	1600nF / 22 Ohm	<b>RC-K3N 24</b>	10	0,01
48 - 127V AC/DC	on the	680nF / 270 Ohm	<b>RC-K3N 110</b>	10	0,01
110 - 230V AC/DC	contactor	220nF / 2200 Ohm	<b>RC-K3N 230</b>	10	0,01
230 - 415V AC/DC		120nF / 620 Ohm	<b>RC-K3N 400</b>	10	0,01

### RC-units for contactors K3-07 - K3-74 and reversing contactors K3NWU10 - K3WU74

12 - 48V AC/DC	to snap	1600nF / 22 Ohm	<b>RC-K3NW 24</b>	10	0,01
48 - 127V AC/DC	on the	680nF / 270 Ohm	<b>RC-K3NW 110</b>	10	0,01
110 - 230V AC/DC	contactor	220nF / 2200 Ohm	<b>RC-K3NW 230</b>	10	0,01
230 - 415V AC/DC		120nF / 620 Ohm	<b>RC-K3NW 400</b>	10	0,01

## Mounting Parts



Description	For Type	Specification	Type	Pack pcs.	Weight kg/pc.
-------------	----------	---------------	------	--------------	------------------

<b>Clamp, no distance</b>	K3-07 to K3-115 K2-07 to K2-37	To join contactors without distance, 2 pieces required	<b>P426-1</b>	50	0,001
---------------------------	-----------------------------------	--	---------------	----	-------



<b>Clamp, 7mm distance</b>	K3-07 to K3-115 K2-07 to K2-37	To join contactors with 7mm distance, 2 pieces required	<b>P418-1</b>	10	0,002
----------------------------	-----------------------------------	---	---------------	----	-------

<b>Clamp, 12mm distance</b>	K3-07 to K3-115 K2-07 to K2-37	To join contactors with 12mm distance, 2 pieces required	<b>P807-1</b>	10	0,002
-----------------------------	-----------------------------------	--	---------------	----	-------

<b>Clamp asymmetric</b>	K3-07 to K3-40 with K3-50 to K3-74	To join contactors with 12mm distance, 2 pieces required	<b>P785-1</b>	10	0,002
-------------------------	---------------------------------------	--	---------------	----	-------



<b>Retention clamp</b>	K3-10 to K3-74	To close contactors	<b>P725</b>		
------------------------	----------------	---------------------	-------------	--	--

## Marking System for contactors K3-07.. to K3-115.., K2-.. and aux. contact blocks HN and HA



Description	Specification	Type	Pack pcs.	Weight kg/100pc
-------------	---------------	------	--------------	--------------------

<b>Marking Plate</b>	2-section without marking, divisible	<b>P487-1</b>	100	0,025
----------------------	--------------------------------------	---------------	-----	-------

<b>Marking Plate</b>	3-section without marking, divisible	<b>P971-1</b>	100	0,038
----------------------	--------------------------------------	---------------	-----	-------

<b>Marking Plate</b>	4-section without marking, divisible	<b>P245-1</b>	100	0,050
----------------------	--------------------------------------	---------------	-----	-------

<b>Marking Plate</b>	marked, choice of K1...K32	<b>P245-K..</b>	100	0,013
----------------------	----------------------------	-----------------	-----	-------

## Coil voltages for AC operated contactors

### Type-suffix for coil-types K6/.. to K45/... for contactor-types K3-07.. to K3-74

Suffix to contactor type	to coil type	Voltage Marking		Rated Control Voltage U <sub>s</sub>			
		at the coil for 50Hz V	for 60Hz V	range for 50Hz min. max.		for 60Hz min. max.	
6	41.6	6		6	6,6	6,6	7,3
6,6	41.6,6	6,6		6,6	7,3	7,3	8
7,3	41.7,3	7,3		7,3	8	8	9
8	41.8	8		8	9	9	10
9	41.9	9		9	10	10	11
10	41.10	10		10	11	11	12
11	41.11	11	12	11	12	12	13,2
12	41.12	12		12	13,2	13,2	14,5
13,2	41.13	13,2		13,2	14,5	14,5	16
14,5	41.14	14,5		14,5	16	16	18
16	41.16	16		16	18	18	20
18	41.18	18		18	20	20	22
20	41.20	20		20	22	22	24
<b>24</b>	<b>4.24</b>	<b>24</b>	<b>24</b>	<b>22</b>	<b>24</b>	<b>24</b>	<b>27</b>
25	41.25	25		24	27	27	30
27	41.27	27	32	27	30	30	33
32	41.32	32	36	30	33	33	36
33	41.33	36	36	33	36	36	39
36	41.36	36	42	36	39	39	42
40	41.40	42	42	39	42	42	47
<b>42</b>	<b>4.42</b>	<b>42</b>	<b>48</b>	<b>42</b>	<b>47</b>	<b>47</b>	<b>52</b>
48	41.48	48	48	44	48	48	52
55	41.55	55	60	52	58	58	65
60	41.60	60		58	65	65	72
65	41.65	65		65	72	72	80
75	41.75	75		72	80	80	90
85	41.85	85		80	90	90	100
90	41.90	100	100	90	100	100	110
<b>110</b>	<b>4.110</b>	<b>110</b>	<b>110-120</b>	<b>100</b>	<b>110</b>	<b>110</b>	<b>122</b>
115	41.115	115	125	110	122	122	135
127	41.127	127		122	135	135	150
140	41.140	140		135	150	150	165
150	41.150	150		150	165	165	180
165	41.165	165	180-208	165	180	180	208
180	41.180	180-210 <sup>1)</sup>	200-240 <sup>1)</sup>	180	210 <sup>1)</sup>	200	240 <sup>1)</sup>
190R <sup>2)</sup>	41.190	200-240	200-240	200	240	200	240
200	41.200	200-230 <sup>1)</sup>	220-240	200	230 <sup>1)</sup>	220	240
<b>230</b>	<b>4.230</b>	<b>220-240</b>	<b>230-264</b>	<b>220</b>	<b>240</b>	<b>230</b>	<b>264</b>
254	41.254	254	277	240	264	264	290
270	41.270	270		264	290	290	315
300	41.300	300		290	315	315	345
320	41.320	320		315	345	345	380
345	41.345	345-400 <sup>1)</sup>	380-440 <sup>1)</sup>	345	400 <sup>1)</sup>	380	440 <sup>1)</sup>
390R <sup>2)</sup>	41.390	400-480	400-480	400	480	400	480
<b>400</b>	<b>4.400</b>	<b>380-415</b>	<b>400-440</b>	<b>380</b>	<b>415</b>	<b>400</b>	<b>460</b>
415	41.415	415-440	440-480	400	440	440	480
440	41.440	440-480	480-500	440	480	480	530
480	41.480	480-500	530-580	480	530	530	580
500	41.500	500-550	550-600	500	550	550	600
550	41.550	550-600	600	550	600	600	(650)

### Standard voltages in bold type letters.

- 1) Operating range of magnet-coils: 0,85 x U<sub>s</sub> (min. value of rated control voltage) up to 1,05 x U<sub>s</sub> (max. value of rated control voltage).  
2) Reduction of mechanical life to 10% of normal life. It is not admissible as a spare coil in a contactor for different coil voltages.

### Type-suffix for coil-types K85/... and K110/... for contactor-types K85 to K110

Suffix to contactor type	to coil type	Voltage Marking		Rated Control Voltage U <sub>s</sub>			
		at the coil for 50Hz V	for 60Hz V	range for 50Hz min. max.		for 60Hz min. max.	
20	4.20	20	24	20	22	24	26
24	4.24	24		24	27	29	32
42	4.42	42		42	47	50	56
110	4.110	110-120		110	122	132	146
<b>230</b>	<b>4.230</b>	<b>220-240</b>	<b>277</b>	<b>220</b>	<b>240</b>	<b>264</b>	<b>288</b>
400	4.400	380-415	460-480	380	415	455	498

### Type-suffix for coil-types K3-1200/... for contactor-types K3-1000.. to K3-1200..

110	4.110	110-115	-	110	115	110	115
<b>230</b>	<b>4.230</b>	<b>220-230</b>	-	<b>220</b>	<b>230</b>	<b>220</b>	<b>230</b>
<b>400</b>	<b>4.400</b>	<b>380-400</b>	-	<b>380</b>	<b>400</b>	<b>380</b>	<b>400</b>
440	4.440	440	-	440	440	440	440

## Coil voltages for AC and DC operated contactors

### Type-suffix for coil-types K3-115/.. to K3-860/... for contactor-types K3-90.. to K3-860..

Suffix to contactor type	to coil type	Voltage Marking		Rated Control Voltage U <sub>s</sub>			
		at the coil for 50/60Hz V	for DC V	range for 50Hz min. max.		for 60Hz min. max.	
24	4.24	24	24	22	24	22	24
48	4.48	48	48	44	48	44	48
110	4.110	110-120	110	110	120	110	120
<b>230</b>	<b>4.230</b>	<b>220-240</b>	<b>220</b>	<b>220</b>	<b>240</b>	<b>220</b>	<b>240</b>
<b>400</b>	<b>4.400</b>	<b>380-415</b>	-	<b>380</b>	<b>415</b>	<b>380</b>	<b>415</b>

## Coil voltages for AC operated contactors

### Type-suffix for coil-types K3-115/..AC for contactor-types K3-90..AC to K3-115..AC

Suffix to contactor type	to coil type	Voltage Marking		Rated Control Voltage U <sub>s</sub>			
		at the coil for 50Hz V	for 60Hz V	range for 50Hz min. max.		for 60Hz min. max.	
<b>110AC</b>	<b>4.110AC</b>	110-122	132-146	110	122	132	146
<b>230AC</b>	<b>4.230AC</b>	<b>220-240</b>	<b>277</b>	<b>220</b>	<b>240</b>	<b>264</b>	<b>288</b>

Other coil voltages on request

**Operating range of magnet-coils: 0,85 x U<sub>s</sub> (min. value of rated control voltage) up to 1,1 x U<sub>s</sub> (max. value of rated control voltage)**

With reduced control voltage range 0,9 up to 1,0 x U<sub>s</sub> at ambient temperature 60 - 90°C



## Spare Coils for AC operated contactors



		Type	Coil voltage <sup>1)</sup>	Pack pcs.	Weight kg/pc.
For Contactors		<b>4.24</b>	24V 50Hz		
		<b>4.42</b>	42V 50Hz		
		<b>4.110</b>	110V 50Hz		
		<b>41.180</b>	180V 50Hz, 220V 60Hz		
		<b>4.230</b>	220-240V 50Hz		
		<b>4.400</b>	380-415V 50Hz		
		↓			
K3-07N.. up to K3-22N..		<b>K10N/ . . .EUR</b>		1	0,053
K3-07.. up to K3-22..		<b>K3-6/ . . .</b>		10	0,040
K2-07.. up to K2-16..		<b>K6/ . . .</b>		10	0,040
K3-24.. up to K3-40..		<b>K24/ . . .</b>		1	0,085
K2-23.. up to K2-37..		<b>K23/ . . .</b>		1	0,085
K3-50.. up to K3-74.., K2-45.., K2-60..		<b>K45/ . . .</b>		1	0,110
K65.., K85..		<b>K85/ . . .</b>		1	0,215
K110..		<b>K110/ . . .</b>		1	0,220
For Contactors		Type	Coil voltage <sup>1)</sup>	pcs.	kg/pc.
		<b>4.110</b>	110V 50Hz, 110-115V 60Hz		
		<b>4.230</b>	220-230V 50Hz		
		<b>4.400</b>	380-400V 50Hz		
		↓			
K3-150.., K3-175..		<b>K3-175/ . . .</b>		1	0,38
K3-1000.., K3-1200..	without feeder group <sup>2)</sup>	<b>K3-1200/ . . .</b>		1	3,12

## Spare Coils for AC and DC operated contactors



		Type	Coil voltage <sup>1)</sup>	Pack pcs.	Weight kg/pc.
For Contactors		<b>4.24</b>	24V 50/60Hz / 24V DC		
		<b>4.110</b>	110-120V 50/60Hz / 110V DC		
		<b>4.230</b>	220-240V 50/60Hz / 220V DC		
		<b>4.400</b>	380-415V 50/60Hz		
		↓			
K3-90.., K3-115..	with feeder group	<b>K3-115/ . . .</b>		1	0,30
K3-151.., K3-176..	with feeder group	<b>K3-176/ . . .</b>		1	0,68
K3-210.., K3-316..	with feeder group	<b>K3-316/ . . .</b>		1	0,68
K3-450.., K3-550..	without feeder group <sup>2)</sup>	<b>K3-550/ . . .</b>		1	1,63
K3-700.., K3-860..	without feeder group <sup>2)</sup>	<b>K3-860/ . . .</b>		1	2,44

## Spare Feeder Groups for contactors K3-450.. to K3-860..

In case of changing control voltage, change coil and feeder group too

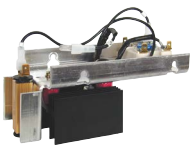

		Type	Coil voltage <sup>1)</sup>	Pack pcs.	Weight kg/pc.
For Contactors		<b>110</b>	110-120V 50/60Hz / 110V DC		
		<b>230</b>	220-240V 50/60Hz / 220V DC		
		<b>400</b>	380-415V 50/60Hz		
		↓			
K3-450.., K3-550..	K3-550/4...	<b>K3-550/FG . . .</b>		1	0,33
K3-700.., K3-860..	K3-860/4..	<b>K3-860/FG . . .</b>		1	0,54

1) Coil voltage range and non-standard coil voltages see page 57

2) In case of changing control voltage, change coil and feeder group too

# Spare Coils for DC operated contactors

Aux. Contact Block  
for double winding coil

Type	Coil voltage <sup>1)</sup>
<b>47.24</b>	24V DC
<b>47.48</b>	48V DC
<b>47.110</b>	110V DC
<b>47.220</b>	220V DC

For Contactors

For Contactors	Aux. Contact Block	Type	Pack pcs.	Weight kg/pc.
K3-07N..= up to K3-22N..=	HN01U	<b>K10N/ ...</b>	1	0,052
K3-07..= up to K3-22..=	HN01U	<b>K3-6/ ...</b>	1	0,042
K2-07..= up to K2-16..=	HN01U	<b>K6/ ...</b>	1	0,042
K3-24..= up to K3-40..=	HN01X	<b>K24/ ...</b>	1	0,090
K2-23..= up to K2-37..=	HN01X	<b>K23/ ...</b>	1	0,090
K3-50..= up to K3-74..=, K2-45..=, K2-60..=	HN01Z	<b>K45/ ...</b>	1	0,115
K65..=, K85..=	-	<b>K85/ ...</b>	1	0,220
K110..=	-	<b>K110/ ...</b>	1	0,225



Type	Coil voltage <sup>1)</sup>
<b>43.110</b>	110V DC
<b>43.220</b>	220V DC

For Contactors

For Contactors	Aux. Contact Block	Type	Pack pcs.	Weight kg/pc.
K3-1000..=, K3-1200..=	without feeder group <sup>2)</sup>	<b>K3-1200/ ...</b>	1	3,12

## Wiring Diagrams for Coil Circuit

AC operated,

**K3-07..**  
up to **K110..**



DC operated  
with double winding coil

**K3-07..=**  
up to **K3-22..=**

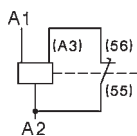

DC operated

**KG3..**

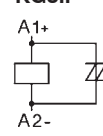

AC and DC operated  
with double winding coil  
**K3-90A00, K3-115A00**  
**K3-151A00, K3-176A00**  
**K3-210A00 to K3-316A00**

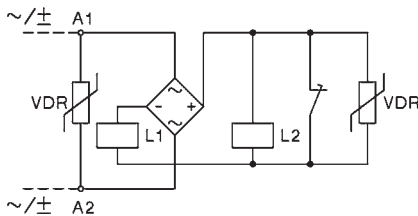

**K3-24..=**  
to  
**K3-74..=**

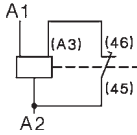

AC and DC operated  
with series resistor  
**K3-200A21**  
**K3-315A21**

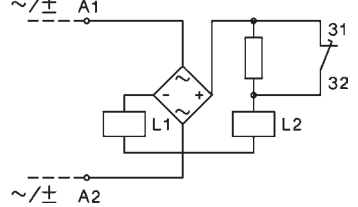

**K85..=**  
**K110..=**

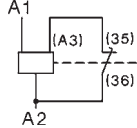

AC and DC operated  
with series resistor  
**K3-450..** up to **K3-860..**

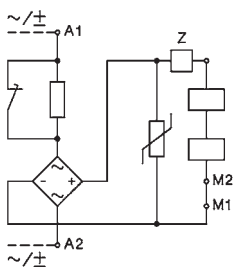

DC operated  
with DC coil  
**K3-1000.., K3-1200..**

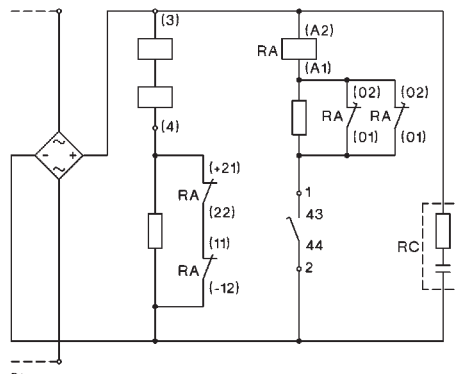

AC operated  
with DC coil  
**K3-1000.., K3-1200..**

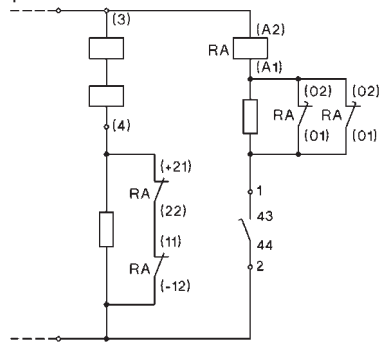

Adjustable dropout operating time for K3-450.. to K3-860..  
150-200ms: Wiring see above (delivery standard)  
500-1000ms: Jumper device "Z"  
approx. 20ms: Special wiring see package folder

Contactors K3-1000.., K3-1200..  
For control voltages up to 125V  
NC contacts 21-22 and 11-12 are connected parallel,  
for higher voltages contacts are connected in series (delivery standard).

1) Other coil voltages on request  
2) In case of changing control voltage, change coil and feeder group too

## Spare Contacts

<b>Main Contacts</b> for Contactors	<b>Type</b>	Pack pcs.	Weight kg/pc.
K85..	<b>EK85/1</b>	3	0,235
K110..	<b>EK110/1</b>	3	0,275
K3-150..	<b>EK3-150/10</b>	1	0,32
K3-151..	<b>EK3-151/10</b>	1	0,16
K3-175..	<b>EK3-175/10</b>	1	0,32
K3-176..	<b>EK3-176/10</b>	1	0,16
K3-200..	<b>EK3-200/10</b>	1	0,18
K3-210..	<b>EK3-210/10</b>	1	0,18
K3-260..	<b>EK3-260/10</b>	1	0,30
K3-315..	<b>EK3-315/10</b>	1	0,34
K3-316..	<b>EK3-316/10</b>	1	0,34
K3-450..	<b>EK3-450/10</b>	1	0,35
K3-550..	<b>EK3-550/10</b>	1	0,35
K3-700..	<b>EK3-700/10</b>	1	0,85
K3-860..	<b>EK3-860/10</b>	1	1,0
K3-1000..	<b>EK3-1000/10</b>	1	1,4
K3-1200..	<b>EK3-1200/10</b>	1	1,4

# Approximate Values for three-phase Motors

## Motor Full Load Currents

Approximate values of motor F.L.C. and minimum "slow blow" respectively "gL" short-circuit fuse

Motor rating	Range acc. to BS for 415V				220-230V Motor fuse size motor start			240V Motor fuse size motor start			380-400V Motor fuse size motor start			415V Motor fuse size motor start			500V Motor fuse size motor start			660-690V Motor fuse size motor start		
	kW	PS~hp	hp	cosφ %	I <sub>n</sub> A	D.O.L. A	YD A	I <sub>n</sub> A	D.O.L. A	YD A	I <sub>n</sub> A	D.O.L. A	YD A	I <sub>n</sub> A	D.O.L. A	YD A	I <sub>n</sub> A	D.O.L. A	YD A	I <sub>n</sub> A	D.O.L. A	YD A
<b>0,06</b>	0,08	-	0,7	59	0,38	1	1	0,35	1	1	<b>0,22</b>	1	1	-	-	-	0,16	1	1	-	-	-
<b>0,09</b>	0,12	-	0,7	60	0,55	2	2	0,5	2	2	<b>0,33</b>	1	1	-	-	-	0,24	1	1	-	-	-
<b>0,12</b>	0,16	-	0,7	61	0,76	2	2	0,68	2	2	<b>0,42</b>	2	2	-	-	-	0,33	1	1	-	-	-
<b>0,18</b>	0,24	-	0,7	61	1,1	2	2	1	2	2	<b>0,64</b>	2	2	-	-	-	0,46	1	1	-	-	-
<b>0,25</b>	0,34	-	0,7	62	1,4	4	2	1,38	4	2	<b>0,88</b>	2	2	-	-	-	0,59	2	2	-	-	-
<b>0,37</b>	0,5	-	0,72	64	2,1	4	4	1,93	4	4	<b>1,22</b>	4	2	-	-	-	0,85	2	2	0,7	2	2
<b>0,55</b>	0,75	-	0,75	69	2,7	4	4	2,3	4	4	<b>1,5</b>	4	2	-	-	-	1,2	4	2	0,9	2	2
<b>0,75</b>	1	1	0,8	74	3,3	6	4	3,1	6	4	<b>2</b>	4	4	2	4	4	1,48	4	2	1,1	2	2
<b>1,1</b>	1,5	1,5	0,83	77	4,9	10	6	4,1	6	6	<b>2,6</b>	4	4	2,5	4	4	2,1	4	4	1,5	4	2
<b>1,5</b>	2	2	0,83	78	6,2	10	10	5,6	10	10	<b>3,5</b>	6	4	3,5	6	4	2,6	4	4	2	4	4
<b>2,2</b>	3	3	0,83	81	8,7	16	10	7,9	16	10	<b>5</b>	10	6	5	10	6	3,8	6	6	2,9	6	4
<b>2,5</b>	3,4	-	0,83	81	9,8	16	16	8,9	16	10	<b>5,7</b>	10	10	-	-	-	4,3	6	6	-	-	-
<b>3</b>	4	4	0,84	81	11,6	20	16	10,6	20	16	<b>6,6</b>	16	10	6,5	16	10	5,1	10	10	3,5	6	4
<b>3,7</b>	5	5	0,84	82	14,2	25	20	13	25	16	<b>8,2</b>	16	10	7,5	16	10	6,2	16	10	-	-	-
<b>4</b>	5,5	-	0,84	82	15,3	25	20	14	25	20	<b>8,5</b>	16	10	-	-	-	6,5	16	10	4,9	10	6
<b>5,5</b>	7,5	7,5	0,85	83	20,6	35	25	18,9	35	25	<b>11,5</b>	20	16	11	20	16	8,9	16	10	6,7	16	10
<b>7,5</b>	10	10	0,86	85	27,4	50	35	24,8	50	35	<b>15,5</b>	25	20	14	25	16	11,9	20	16	9	16	10
<b>8</b>	11	-	0,86	85	28,8	50	35	26,4	50	35	<b>16,7</b>	25	20	21	25	16	12,7	20	16	-	-	-
<b>11</b>	15	15	0,86	87	39,2	63	50	35,3	63	50	<b>22</b>	35	25	21	35	25	16,7	25	20	13	25	16
<b>12,5</b>	17	-	0,86	87	43,8	63	50	40,2	63	50	<b>25</b>	35	25	-	-	-	19	35	25	-	-	-
<b>15</b>	20	20	0,86	87	52,6	80	63	48,2	80	63	<b>30</b>	50	35	28	35	35	22,5	35	25	17,5	25	20
<b>18,5</b>	25	25	0,86	88	64,9	100	80	58,7	100	80	<b>37</b>	63	50	35	50	50	28,5	50	35	21	35	25
<b>20</b>	27	-	0,86	88	69,3	100	80	63,4	100	80	<b>40</b>	63	50	-	-	-	30,6	50	35	-	-	-
<b>22</b>	30	30	0,87	89	75,2	100	80	68	100	80	<b>44</b>	63	50	40	63	50	33	50	35	25	35	35
<b>25</b>	34	-	0,87	89	84,4	125	100	77,2	100	100	<b>50</b>	80	63	-	-	-	38	63	50	-	-	-
<b>30</b>	40	40	0,87	90	101	125	125	92,7	125	100	<b>60</b>	80	63	55	80	63	44	63	50	33	50	35
<b>37</b>	50	50	0,87	90	124	160	160	114	160	125	<b>72</b>	100	80	66	100	80	54	80	63	42	63	50
<b>40</b>	54	-	0,87	90	134	160	160	123	160	160	<b>79</b>	100	100	-	-	-	60	80	63	-	-	-
<b>45</b>	60	60	0,88	91	150	200	160	136	200	160	<b>85</b>	125	100	80	100	100	64,5	100	80	49	63	63
<b>50</b>	70	-	0,88	91	168	200	200	154	200	200	<b>97</b>	125	100	-	-	-	73,7	100	80	-	-	-
<b>55</b>	75	-	0,88	91	181	250	200	166	200	200	<b>105</b>	160	125	-	-	-	79	125	100	60	80	63
<b>59</b>	80	80	0,88	91	194	250	250	178	250	200	<b>112</b>	160	125	105	160	125	85,3	125	100	-	-	-
<b>75</b>	100	100	0,88	91	245	315	250	226	315	250	<b>140</b>	200	160	135	200	160	106	160	125	82	125	100
<b>90</b>	125	125	0,88	92	292	400	315	268	315	315	<b>170</b>	250	200	165	200	200	128	160	160	98	125	125
<b>110</b>	150	150	0,88	92	358	500	400	327	400	400	<b>205</b>	250	250	200	250	250	156	200	200	118	160	125
<b>129</b>	175	175	0,88	92	420	500	500	384	500	400	<b>242</b>	315	250	230	315	250	184	250	200	-	-	-
<b>132</b>	180	-	0,88	92	425	500	500	393	500	500	<b>245</b>	315	250	-	-	-	186	250	200	140	200	160
<b>147</b>	200	200	0,88	93	472	630	630	432	630	500	<b>273</b>	315	315	260	315	315	207	250	250	-	-	-
<b>160</b>	220	-	0,88	93	502	630	630	471	630	630	<b>295</b>	400	315	-	-	-	220	315	250	170	200	200
<b>184</b>	250	250	0,88	93	590	800	630	541	630	630	<b>340</b>	400	400	325	400	400	259	315	315	-	-	-
<b>200</b>	270	-	0,88	93	626	800	800	589	800	630	<b>370</b>	500	400	-	-	-	278	315	315	215	250	250
<b>220</b>	300	300	0,88	93	700	1000	800	647	800	800	<b>408</b>	500	500	385	500	400	310	400	400	-	-	-
<b>250</b>	340	-	0,88	93	803	1000	1000	736	1000	800	<b>460</b>	630	500	-	-	-	353	500	400	268	315	315
<b>257</b>	350	350	0,88	93	826	1000	1000	756	1000	800	<b>475</b>	630	630	450	630	500	363	500	400	-	-	-
<b>295</b>	400	400	0,88	93	948	1250	1000	868	1000	1000	<b>546</b>	800	630	500	630	630	416	500	500	-	-	-
<b>315</b>	430	-	0,88	93	990	1250	1250	927	1250	1000	<b>580</b>	800	630	-	-	-	445	630	500	337	400	400
<b>355</b>	483	-	0,89	95	-	-	-	-	-	-	<b>636</b>	800	800	-	-	-	483	630	630	366	500	400
<b>400</b>	545	-	0,89	96	-	-	-	-	-	-	<b>710</b>	1000	800	-	-	-	538	630	630	410	500	500

The motor F.L.C. be valid for standard internal and surface cooled three-pole motors with 1500 min<sup>-1</sup>. The fuses values be valid for the motor F.L.C. shown in the table and D.O.L.-start: starting current max. 6x motor F.L.C., starting time max. 5s; star-delta-start: starting current max. 2x motor F.L.C., starting time max. 15s

For motors with higher F.L.C., higher starting current and / or longer starting time, larger short-circuit fuses are required. The maximum admissible value is dependent on the switchgear respectively thermal overload relay.

## Approximate values of motor F.L.C. according to CSA and UL

Motor rating hp	Motor F.L.C. at 110-120V			Motor F.L.C. at 220-240V <sup>1)</sup>			Motor F.L.C. at 440-480V			Motor F.L.C. at 550-600V		
	1-phase A	2-phase A	3-phase A	1-phase A	2-phase A	3-phase A	1-phase A	2-phase A	3-phase A	1-phase A	2-phase A	3-phase A
1/2	9,8	4,0	4,4	4,9	2,0	2,2	2,5	1,0	1,1	2,0	0,8	0,9
3/4	13,8	4,8	6,4	6,9	2,4	3,2	3,5	1,2	1,6	2,8	1,0	1,3
1	16,0	6,4	8,4	8,0	3,2	4,2	4,0	1,6	2,1	3,2	1,3	1,7
1-1/2	20,0	9,0	12,0	10,0	4,5	6,0	5,0	2,3	3,0	4,0	1,8	2,4
2	24,0	11,8	13,6	12,0	5,9	6,8	6,0	3,0	3,4	4,8	2,4	2,7
3	34,0	16,6	19,2	17,0	8,3	9,6	8,5	4,2	4,8	6,8	3,3	3,9
5	56,0	26,4	30,4	28,0	13,2	15,2	14,0	6,6	7,6	11,2	5,3	6,1
7-1/2	80,0	38,0	44,0	40,0	19,0	22,0	21,0	9,0	11,0	16,0	8,0	9,0
10	100,0	48,0	56,0	50,0	24,0	28,0	26,0	12,0	14,0	20,0	10,0	11,0
15	135,0	72,0	84,0	68,0	36,0	42,0	34,0	18,0	21,0	27,0	14,0	17,0
20	-	94,0	108,0	88,0	47,0	54,0	44,0	23,0	27,0	35,0	19,0	22,0
25	-	118,0	136,0	110,0	59,0	68,0	55,0	29,0	34,0	44,0	24,0	27,0
30	-	138,0	160,0	136,0	69,0	80,0	68,0	35,0	40,0	54,0	28,0	32,0
40	-	180,0	208,0	176,0	90,0	104,0	88,0	45,0	52,0	70,0	36,0	41,0
50	-	226,0	260,0	216,0	113,0	130,0	108,0	56,0	65,0	86,0	45,0	52,0
60	-	-	-	-	133,0	145,0	-	67,0	77,0	-	53,0	62,0
75	-	-	-	-	166,0	192,0	-	83,0	96,0	-	66,0	77,0
100	-	-	-	-	218,0	248,0	-	10				

# Contactors

## Data according to IEC 947-4-1, EN 60947-4-1, VDE 0660

Main Contacts	Type	K(G)3-10	K(G)3-14	K(G)3-18	K(G)3-22	K(G)3-24	K(G)3-32	K(G)3-40	K3-50	K3-62	K3-74
<b>Rated insulation voltage <math>U_i</math></b> <sup>1)</sup>	V AC	690	690	690	690	690	690	690	830	830	830
<b>Making capacity <math>I_{eff}</math></b> at $U_e = 690V$ AC	A	200	200	200	200	400	500	500	700	900	900
	1000V AC	-	-	-	-	-	-	-	-	-	-
<b>Breaking capacity <math>I_{eff}</math></b> 400V AC	A	180	180	200	200	380	400	400	600	800	800
K3-10 to K3-22 $\cos\phi = 0,65$	A	150	150	180	180	300	370	370	500	700	700
K3-24 to K3-1200 $\cos\phi = 0,35$	A	100	100	150	150	260	340	340	400	500	500
	1000V AC	-	-	-	-	-	-	-	-	-	-
<b>Utilization category AC1</b>											
<b>Switching of resistive load</b>											
Rated operational current $I_e (=I_{th})$ at 40°C, open	690V A	<b>25</b>	<b>25</b>	<b>32</b>	<b>32</b>	<b>50</b>	<b>65</b>	<b>80</b>	<b>110</b>	<b>120</b>	<b>130</b>
Rated operational power of three-phase resistive loads 50-60Hz, $\cos\phi = 1$	220V kW	9,5	9,5	12,2	12,2	19,0	24,7	30,4	41,9	45,7	49,5
	230V kW	9,9	9,9	12,7	12,7	19,9	25,9	31,8	43,8	47,7	51,7
	240V kW	10,4	10,4	13,3	13,3	20,8	27,0	33,2	45,7	49,8	54,0
	380V kW	16,4	16,4	21,0	21,0	32,9	42,7	52,6	72,3	78,9	85,5
	400V kW	17,3	17,3	22,1	22,1	34,6	45,0	55,4	76,1	83,0	90,0
	415V kW	17,9	17,9	23,0	23,0	35,9	46,7	57,4	79,0	86,2	93,3
	440V kW	19,0	19,0	24,4	24,4	38,1	49,5	60,9	83,7	91,3	99,0
	500V kW	21,6	21,6	27,7	27,7	43,3	56,2	69,2	95,2	103,8	112,5
	660V kW	28,5	28,5	36,5	36,5	57,1	74,2	91,3	125,6	137,0	148,4
	690V kW	29,8	29,8	38,2	38,2	59,7	77,6	95,5	131,3	143,2	155,2
	1000V kW	-	-	-	-	-	-	-	-	-	-
Rated operational current $I_e (=I_{th})$ at 60°C, enclosed	690V A	25	25	32	32	40	55	65	90	100	110
Rated operational power of three-phase resistive loads 50-60Hz, $\cos\phi = 1$	220V kW	9,5	9,5	12,2	12,2	15,2	20,9	24,7	34,3	38,1	41,9
	230V kW	9,9	9,9	12,7	12,7	15,9	21,9	25,9	35,8	39,8	43,8
	240V kW	10,4	10,4	13,3	13,3	16,6	22,8	27,0	37,4	41,5	45,7
	380V kW	16,4	16,4	21,0	21,0	26,3	36,2	42,7	59,2	65,7	72,3
	400V kW	17,3	17,3	22,1	22,1	27,7	38,1	45,0	62,3	69,2	76,1
	415V kW	17,9	17,9	23,0	23,0	28,7	39,5	46,7	64,6	71,8	79,0
	440V kW	19,0	19,0	24,4	24,4	30,4	41,9	49,5	68,5	76,1	83,7
	500V kW	21,6	21,6	27,7	27,7	34,6	47,6	56,2	77,9	86,5	95,2
	660V kW	28,5	28,5	36,5	36,5	45,7	62,8	74,2	102,8	114,2	125,6
	690V kW	29,8	29,8	38,2	38,2	47,7	65,7	77,6	107,4	119,4	131,3
	1000V kW	-	-	-	-	-	-	-	-	-	-
Minimum cross-section of conductor at load with $I_e (=I_{th})$	mm <sup>2</sup>	4	4	6	6	10	16	25	35	50	50
<b>Utilization category AC2 and AC3</b>											
<b>Switching of three-phase motors</b>											
Rated operational current $I_e$ open and enclosed	220V A	12	15	18	22	24	32	40	50	63	74
	230V A	11,5	14,5	18	22	24	32	40	50	62	74
	240V A	11	14	18	22	24	32	40	50	62	74
	<b>380-400V A</b>	<b>10</b>	<b>14</b>	<b>18</b>	<b>22</b>	<b>24</b>	<b>32</b>	<b>40</b>	<b>50</b>	<b>62</b>	<b>74</b>
	415V A	9	14	18	22	23	30	40	50	62	74
	440V A	9	14	18	22	23	30	40	50	62	74
	500V A	8,9	11,9	15	15	22,5	28,5	28,5	44	54	64,5
	660-690V A	6,7	9	12	12	17,5	21	21	33	42	49
	1000V A	-	-	-	-	-	-	-	-	-	-
Rated operational power of three-phase motors 50-60Hz	220-230V kW	3	4	5	6	6	8,5	11	12,5	18,5	22
	240V kW	3	4	5	7	7	9	11,5	13,5	19	23
	<b>380-400V kW</b>	<b>4</b>	<b>5,5</b>	<b>7,5</b>	<b>11</b>	<b>11</b>	<b>15</b>	<b>18,5</b>	<b>22</b>	<b>30</b>	<b>37</b>
	415V kW	4,5	6	8,5	12	12	16	20	24	33	40
	440V kW	4,5	6	8,5	12	12	16	20	24	33	40
	500V kW	5,5	7,5	10	10	15	18,5	18,5	30	37	45
	660-690V kW	5,5	7,5	10	10	15	18,5	18,5	30	37	45
	1000V kW	-	-	-	-	-	-	-	-	-	-

1) Suitable at 690V for: earthed-neutral systems, overvoltage category I to IV, pollution degree 3 (standard-industry):  $U_{imp} = 8kV$ .  
Data for other conditions on request.

# Contactors

Data according to IEC 947-4-1, EN 60947-4-1, VDE 0660

Type	K3-90	K3-115	K3-116	K3-151	K3-176	K3-210	K3-260	K3-316	K3-450	K3-550	K3-700	K3-860	K3-1000	K3-1200
V AC	1000	1000	1000	1000	1000	1000	1000	1000	1000	1000	690	690	690	690
A	1100	1200	1200	1500	2000	2100	2600	3200	4500	5500	7000	8600	10000	12000
A	540	600	600	720	840	1020	1200	1500	2400	3000	-	-	-	-
A	950	1100	1000	1200	1500	1600	2100	2600	4500	5500	7000	8000	8000	10000
A	850	1000	1000	1200	1500	1600	2100	2600	4500	5500	7000	8000	8000	10000
A	600	600	800	1000	800	1200	1900	2300	3200	4400	5600	6900	7000	8000
A	450	450	400	500	600	700	850	1000	-	-	-	-	-	-
<b>A</b>	<b>160</b>	<b>200</b>	<b>200</b>	<b>250</b>	<b>300</b>	<b>350</b>	<b>450</b>	<b>600</b>	<b>700</b>	<b>800</b>	<b>1000</b>	<b>1100</b>	<b>1200</b>	<b>1350</b>
kW	60	76	76	95	114	133	171	228	266	304	381	419	457	514
kW	63	79	79	99	119	139	179	238	279	318	398	438	478	537
kW	66	83	83	103	124	145	187	249	291	332	415	457	498	561
kW	105	131	131	165	197	230	296	394	460	526	658	724	789	888
kW	110	138	138	173	208	242	311	415	485	554	692	762	831	935
kW	115	143	143	179	215	251	323	430	503	574	718	790	862	970
kW	121	152	152	190	228	266	342	456	533	609	762	838	914	1028
kW	138	173	173	216	260	303	389	518	606	692	866	952	1039	1169
kW	182	228	228	285	343	400	514	684	800	914	1143	1257	1371	1543
kW	191	239	239	298	358	418	537	715	836	955	1195	1314	1434	1613
kW	221	277	216	345	415	433	546	727	692	911	-	-	-	-
A	145	170	170	180	200	280	360	400	550	600	800	875	960	1080
kW	55	64	64	68	76	106	137	152	209	228	304	333	365	411
kW	57	67	67	71	79	111	143	159	219	239	318	348	382	430
kW	59	70	70	74	83	116	150	166	228	249	332	363	399	448
kW	95	111	111	118	131	184	237	263	362	395	526	575	631	710
kW	100	117	117	124	138	193	249	277	381	415	554	606	665	748
kW	104	122	122	129	143	201	259	287	395	431	575	628	690	776
kW	110	129	129	137	152	213	274	304	419	457	609	666	731	823
kW	125	147	147	155	173	242	312	346	476	519	692	757	831	935
kW	165	194	194	205	228	320	412	457	628	685	914	1000	1097	1234
kW	173	202	202	215	239	334	430	478	657	717	956	1045	1147	1290
kW	166	187	216	277	346	388	499	554	692	866	-	-	-	-
mm <sup>2</sup>	95	120	95	95	120	240	2x150	2x(30x6)	2x(40x5)	2x(50x5)	2x(60x5)	2x(60x6)	2x(60x6)	2x(60x8)
A	90	115	115	150	175	210	260	315	450	550	700	860	1000	1200
A	90	115	115	150	175	210	260	315	450	550	700	860	1000	1200
A	90	115	115	150	175	210	260	315	450	550	700	860	1000	1200
<b>A</b>	<b>90</b>	<b>115</b>	<b>115</b>	<b>150</b>	<b>175</b>	<b>210</b>	<b>260</b>	<b>315</b>	<b>450</b>	<b>550</b>	<b>700</b>	<b>860</b>	<b>1000</b>	<b>1200</b>
A	90	115	115	150	175	210	260	315	450	550	700	860	1000	1200
A	90	115	115	150	175	210	260	315	450	550	700	860	1000	1200
A	79	79	115	150	175	210	260	315	450	550	700	860	1000	1200
A	60	60	100	120	140	150	180	240	400	500	630	700	860	1000
A	45	45	45	60	70	85	100	125	200	250	-	-	-	-
kW	25	33	30	40	50	60	75	90	132	175	225	280	325	390
kW	27	35	35	45	55	65	80	100	140	185	235	290	335	400
<b>kW</b>	<b>45</b>	<b>55</b>	<b>55</b>	<b>75</b>	<b>90</b>	<b>110</b>	<b>132</b>	<b>160</b>	<b>250</b>	<b>300</b>	<b>400</b>	<b>500</b>	<b>580</b>	<b>680</b>
kW	49	63	59	80	95	115	140	180	257	315	415	515	600	710
kW	49	63	63	85	100	125	150	190	270	335	450	530	630	750
kW	55	55	75	90	100	132	160	210	300	375	500	600	720	850
kW	55	55	90	110	132	132	160	210	375	500	630	700	850	1000
kW	55	55	55	75	90	110	132	160	280	355	-	-	-	-

# Contactors

## Data according to IEC 947-4-1, EN 60947-4-1, VDE 0660

Main Contacts	Type	K(G)3-10	K(G)3-14	K(G)3-18	K(G)3-22	K(G)3-24	K(G)3-32	K(G)3-40	K3-50	K3-62	K3-74
<b>Utilization category AC4</b>											
<b>Switching of squirrel cage motors, inching</b>											
Rated operational current $I_e$	220V A	12	15	18	18	24	30	40	50	63	63
open and enclosed	230V A	11,5	14,5	18	18	24	30	40	50	62	62
	240V A	11	14	18	18	24	32	40	50	62	62
	<b>380-400V A</b>	<b>10</b>	<b>14</b>	<b>18</b>	<b>18</b>	<b>24</b>	<b>32</b>	<b>40</b>	<b>50</b>	<b>62</b>	<b>62</b>
	415V A	9	14	18	18	23	30	37	45	60	60
	440V A	9	14	18	18	23	30	37	45	55	55
	500V A	9	12	16	16	17,5	21	21	33	42	42
	660V A	7	9	9	9	17	20	20	31	40	40
	690V A	6,5	8,5	8,5	8,5	17	20	20	31	40	40
	1000V A	-	-	-	-	-	-	-	-	-	-
Rated operational power of three-phase motors 50-60Hz	220-230V kW	3	4	5	5	6	8,5	11	12,5	18,5	18,5
	240V kW	3	4	5	5	7	9	11,5	13,5	19	19
	<b>380-400V kW</b>	<b>4</b>	<b>5,5</b>	<b>7,5</b>	<b>7,5</b>	<b>11</b>	<b>15</b>	<b>18,5</b>	<b>22</b>	<b>30</b>	<b>30</b>
	415V kW	4,5	6	8,5	8,5	12	16	20	24	33	33
	440V kW	4,5	6	8,5	8,5	12	16	20	24	33	33
	500V kW	5,5	7,5	10	10	15	18,5	18,5	30	37	37
	660-690V kW	5,5	7,5	10	10	15	18,5	18,5	30	37	37
	1000V kW	-	-	-	-	-	-	-	-	-	-
<b>Utilization category AC5a</b>											
<b>Switching of gas discharge lamps</b>											
Rated operational current $I_e$ per pole at 220/230V											
Fluorescent lamps, uncompensated and serial compensated											
	A	20	20	25	25	40	52	64	88	96	104
parallel compensated	A	7	9	9	9	18	22	22	30	40	40
dual-connection	A	22,5	22,5	28	28	45	58	72	98	108	117
Metal halide lamps <sup>1)</sup> , uncompensated											
	A	12	15	19	19	30	39	48	66	72	78
parallel compensated	A	7	9	9	9	18	22	22	30	40	40
Mercury-vapour lamps <sup>2)</sup> , uncompensated											
	A	22,5	25	28	28	45	58	72	99	108	117
parallel compensated	A	7	9	9	9	18	22	22	30	40	40
Mixed light lamps <sup>3)</sup>											
	A	20	20	25	25	40	52	64	88	96	104
<b>LED-Lamps</b>											
consider the inrush current of the lamp ballast and $\cos\phi$ of the lamp.											
max. lamps per pole ( $I_{rLED} \leq I_{rn}$ )						= $\frac{\text{inrush current of contactor}}{\text{inrush current of lamp/EVG}}$					
max inrush current of contactor	A	282	282	282	282	564	705	705	987	1269	1268
<b>Utilization category AC5b</b>											
<b>Switching of incandescent lamps <sup>4)</sup></b>											
Rated operational current $I_e$ per pole at 220/230V											
	A	12,5	12,5	12,5	12,5	25	31	31	43	56	56

1) Metal halide lamps and sodium-vapour lamps (high- and low-pressure lamps)

2) High-pressure lamps

3) Blended lamps, containing a mercury high-pressure unit and a tungsten helix in a fluorescent glass bulb (daylight lamps)

4) Current inrush approx.  $16 \times I_e$

# Contactors

Data according to IEC 947-4-1, EN 60947-4-1, VDE 0660

Type	K3-90	K3-115	K3-151	K3-176	K3-210	K3-260	K3-316	K3-450	K3-550	K3-700	K3-860	K3-1000	K3-1200
A	85	98	55	63	85	100	120	150	180	230	280	340	400
A	85	98	55	63	85	100	120	150	180	230	280	340	400
A	85	98	55	63	85	100	120	150	180	230	280	340	400
<b>A</b>	<b>85</b>	<b>85</b>	<b>55</b>	<b>63</b>	<b>85</b>	<b>100</b>	<b>120</b>	<b>150</b>	<b>180</b>	<b>230</b>	<b>280</b>	<b>340</b>	<b>400</b>
A	85	85	55	63	85	100	120	150	180	230	280	340	400
A	85	85	55	63	85	100	120	150	180	230	280	340	400
A	85	85	-	-	-	-	-	-	-	-	-	-	-
A	60	60	-	-	-	-	-	-	-	-	-	-	-
A	57,5	57,5	-	-	-	-	-	-	-	-	-	-	-
A	-	-	-	-	-	-	-	-	-	-	-	-	-
kW	25	30	15	18,5	25	30	37	45	51	68	80	110	132
kW	27	32	15,5	19	26	31	38	47	53	71	83	115	137
<b>kW</b>	<b>45</b>	<b>45</b>	<b>25</b>	<b>30</b>	<b>45</b>	<b>55</b>	<b>63</b>	<b>75</b>	<b>90</b>	<b>120</b>	<b>150</b>	<b>185</b>	<b>220</b>
kW	49	49	25	33	45	55	65	80	100	132	160	200	230
kW	49	49	30	34	48	55	67	85	100	132	160	200	230
kW	55	55	25	30	55	65	75	100	110	150	185	220	257
kW	55	55	25	30	55	65	75	100	110	150	185	220	257
kW	-	-	-	-	-	-	-	-	-	-	-	-	-
A	100	120	120	140	180	220	280	360	450	570	700	850	1000
A	55	70	85	100	130	160	200	300	360	460	550	660	800
A	112	144	120	140	180	220	280	360	450	570	700	850	1000
A	85	90	95	110	140	180	230	300	380	490	610	750	890
A	55	70	75	85	110	140	170	260	300	400	480	580	700
A	112	144	120	140	180	220	280	360	450	570	700	850	1000
A	55	70	75	85	110	140	170	260	300	400	480	580	700
A	100	120	100	120	160	200	250	320	400	500	600	700	800
	$\text{max. lamps per pole } (I_{rLED} \leq I_{rn}) = \frac{\text{inrush current of contactor}}{\text{inrush current of lamp/EVG}}$												
A	1551	1692	2115	2820	2961	3666	4512	6345	7755	9870	12126	14100	16920
A	69	75	100	120	160	190	220	260	315	440	500	560	630



# Contactors

## Data according to IEC 947-4-1, EN 60947-4-1, VDE 0660

Main Contacts		Type	K(G)3-10	K(G)3-14	K(G)3-18	K(G)3-22	K(G)3-24	K(G)3-32	K(G)3-40	K3-50	K3-62	K3-74
<b>Utilization category AC6a</b>												
<b>Transformer primary switching</b>												
at inrush		n	30	30	30	30	30	30	30	30	30	30
Rated operational current $I_e$	400V	A	4,5	5,5	7,5	7,5	10,5	13,5	13,5	20	27	33
Rated operational power	220-230V	kVA	1,8	2,2	3	3	4,2	5,4	5,4	8	10,7	13
dependent on inrush n	240V	kVA	1,9	2,3	3,1	3,1	4,3	5,6	5,6	8,3	11,2	13,5
	380-400V	kVA	3,1	3,8	5,2	5,2	7,3	9,3	9,3	13,5	18,5	22,5
For different inrush-factors x	415-440V	kVA	3,4	4,2	5,7	5,7	8	10,2	10,2	15	20,5	25
use the following formula:	500V	kVA	3,9	4,8	6,5	6,5	9	11,5	11,5	17	23	28
$P_x = P_n \cdot (n/x)$	660-690V	kVA	5,4	6,5	9	9	12,5	16	16	24	32	39
<b>Utilization category AC6b</b>												
<b>Switching of three-phase capacitors</b>												
Maximum inrush current (peak value)												
as multiple k of the												
capacitor rated current												
Rated operational current $I_e$	500V	k	35	25	20	20	25	25	25	25	25	20
		A	8	12	15,5	15,5	23	32	32	45	60	70
Rated operational current	220-230V	kVAr	3	4,5	6	6	8,5	12	12	17	24	28
( $\sin\phi=1$ )	240V	kVAr	3,5	5	6,5	6,5	9,5	13	13	18,5	25	29
	380-400V	kVAr	5	7,5	10	10	15	20	20	29	39	46
For different multiples x	415-440V	kVAr	5,5	8	11	11	16	22	22	32	43	50
use the following formula:	500V	kVAr	7	10	13	13	20	26	26	39	50	58
$P_x = P_k \cdot (k/x)$	660-690V	kVAr	7	10	13	13	20	26	26	40	50	58
<b>Switching of reactive capacitor banks</b>												
Rated operational current $I_e$	690V	A	8	13	18	20	28	36	42	48	72	108 <sup>1)</sup>
Rated operational power	220-230V	kVAr	2,9	5	7	7,5	11	14	16	20	28	33
	240V	kVAr	3,1	5,4	7	8	11	14	17	20	28	36
	380-400V	kVAr	5	9	12,5	13	20	25	27,5	33,3	50	75 <sup>1)</sup>
	415-440V	kVAr	5,5	9,5	13	14	22	27	30	36	53	75 <sup>1)</sup>
	500V	kVAr	6	11	15	17	25	30	36	40	60	75
	660-690V	kVAr	8	15	20	22	33	41	48	55	82	100
	1000V	kVAr	-	-	-	-	-	-	-	-	-	-
<b>Utilization category DC1</b>												
<b>Switching of resistive load</b>												
Time constant $L/R \leq 1ms$												
Rated operational current $I_e$	1 pole	24V	A	20	25	32	32	50	65	80	110	130
		60V	A	20	25	32	32	50	65	80	110	130
		110V	A	6	6	6	6	10	10	12	12	12
		220V	A	0,8	0,8	0,8	0,8	1,4	1,4	1,4	1,4	1,4
	3 poles in series	24V	A	20	25	32	32	50	65	80	110	130
		60V	A	20	25	32	32	50	65	80	110	130
		110V	A	20	25	32	32	50	65	80	110	130
		220V	A	16	20	20	20	30	35	35	63	80
<b>Utilization category DC3 and DC5</b>												
<b>Switching of shunt motors and series motors</b>												
Time constant $L/R \leq 15ms$												
Rated operational current $I_e$	1 pole	24V	A	20	25	32	32	50	65	80	110	130
		60V	A	6	6	6	6	30	30	30	60	60
		110V	A	1,2	1,2	1,2	1,2	1,8	1,8	1,8	1,8	1,8
		220V	A	0,2	0,2	0,2	0,2	0,2	0,2	0,25	0,25	0,25
	3 poles in series	24V	A	20	25	32	32	50	65	80	110	130
		60V	A	20	25	32	32	40	40	40	80	80
		110V	A	20	20	20	20	40	40	40	80	80
		220V	A	2,5	2,5	2,5	2,5	4	4	4	5	5

1) Consider resistive load ( $I_{ln}$ ). see page 62

# Contactors

Data according to IEC 947-4-1, EN 60947-4-1, VDE 0660

Type	K3-90	K3-115	K3-151	K3-176	K3-210	K3-260	K3-316	K3-450	K3-550	K3-700	K3-860	K3-1000	K3-1200
n	30	30	30	30	30	30	30	30	30	30	30	30	30
A	38	50	65	80	90	120	142	203	248	315	390	450	540
kVA	15	20	25	30	34	45	54	77	95	120	148	170	200
kVA	15,5	20,5	27	33	37	50	59	80	100	130	160	185	220
kVA	26	34	45	55	60	80	95	140	170	210	270	310	370
kVA	29	38	46	57	63	85	100	145	175	220	280	320	380
kVA	33	43	55	69	75	100	120	170	210	270	330	380	460
kVA	45	60	56	69	100	135	160	200	250	320	350	500	600
k	20	20	20	20	25	20	20	20	20	20	20	20	20
A	87	100	120	155	195	225	255	300	370	440	520	680	760
kVAr	33	38	45	60	75	90	100	115	145	170	200	260	290
kVAr	36	42	52	62	78	94	104	120	150	175	205	270	300
kVAr	57	65	80	100	130	155	170	200	250	300	350	450	500
kVAr	60	70	95	110	135	165	175	210	260	310	360	465	520
kVAr	70	80	100	130	170	194	220	260	320	380	450	590	660
kVAr	70	80	100	130	170	194	220	260	320	380	450	590	660
A	115	144	115	140	200	225	250	330	420	550	600	680	760
kVAr	45	55	43	53	76	85	95	125	160	209	228	260	290
kVAr	45	55	45	55	80	90	100	130	170	220	240	280	310
kVAr	80	100	75	90	130	145	160	210	270	350	390	440	480
kVAr	100	120	80	100	140	160	170	230	290	380	420	470	530
kVAr	105	125	95	120	170	190	210	280	350	450	500	570	640
kVAr	120	148	125	150	200	230	260	350	450	600	650	700	800
kVAr	160	200	155	200	300	340	400	500	650	-	-	-	-
A	160	200	-	-	-	-	-	-	-	-	-	-	-
A	160	200	-	-	-	-	-	-	-	-	-	-	-
A	20	25	-	-	-	-	-	-	-	-	-	-	-
A	2	2,5	-	-	-	-	-	-	-	-	-	-	-
A	160	200	200	250	350	400	450	600	760	1000	1100	1200	1350
A	160	200	200	250	350	400	450	600	760	1000	1100	1200	1350
A	160	200	150	170	250	280	315	400	480	560	630	800	900
A	100	160	80	100	150	180	200	250	315	400	450	500	600
A	160	200	-	-	-	-	-	-	-	-	-	-	-
A	85	110	-	-	-	-	-	-	-	-	-	-	-
A	2	2,5	-	-	-	-	-	-	-	-	-	-	-
A	0,5	0,5	-	-	-	-	-	-	-	-	-	-	-
A	160	200	-	-	-	-	-	-	-	-	-	-	-
A	100	110	-	-	-	-	-	-	-	-	-	-	-
A	100	110	-	-	-	-	-	-	-	-	-	-	-
A	7	8	-	-	-	-	-	-	-	-	-	-	-

Contactors, Motor-Starters

Circuit Breakers

Manual Motor-Starters

Switches

AC-Main Switches



DC-Switch Disconnectors

Push Buttons

Representatives, Suppliers

# Contactors







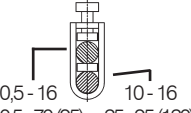

## Data according to IEC 947-4-1, EN 60947-4-1, VDE 0660

Main Contacts		Type	K(G)3-10	K(G)3-14	K(G)3-18	K(G)3-22	K(G)3-24	K(G)3-32	K(G)3-40	K3-50	K3-62	K3-74
<b>Maximum ambient temperature</b>												
Operation	open	°C	-40 to +60 (+90) <sup>1)</sup>									
	enclosed	°C	-40 to +40									
with thermal overload relay	open	°C	-25 to +60									
	enclosed	°C	-25 to +40									
Storage		°C	-50 to +90									
<b>Short circuit protection</b>												
for contactors without thermal overload relay												
Coordination-type "1" according to IEC 947-4-1												
Contact welding without hazard of persons												
max. fuse size	gL (gG)	A	63	63	63	63	100	100	100	160	160	160
Coordination-type "2" according to IEC 947-4-1												
Light contact welding accepted												
max. fuse size	gL (gG)	A	25	35	35	35	50	50	50	100	125	125
Contact welding not accepted												
max. fuse size	gL (gG)	A	16	16	16	16	25	35	35	50	63	63
For contactors with thermal overload relay the device with the smaller admissible backup fuse (contactor or thermal overload relay) determines the fuse size.												
<b>Cable cross-sections</b>												
for contactors without thermal overload relay												
1 cable per clamp												
main connector	solid or stranded	mm <sup>2</sup>	 0,75 - 6				 1,5 - 25			 4 - 50		
	flexible	mm <sup>2</sup>	1 - 4				2,5 - 16			10 - 35		
	flexible with multicore cable end	mm <sup>2</sup>	0,75 - 4				1,5 - 16			6 - 35		
2 cables per clamp												
	solid or stranded	mm <sup>2</sup>	6+(1-6) / 4+(0,75-4)				16+(2,5-16) / 10+(4-16)			50+4 / 35+6 / 25+(6-16)		
	flexible	mm <sup>2</sup>	2,5+(0,75-2,5) / 1,5+(0,75-1,5)				6+(4-16) / 4+(2,5-16)			16+(6-16) / 10+(6-16)		
			6+(1,5-4) / 4+(1-4)				16+(2,5-6) / 10+(4-10)			50+(4-10) / 35+(4-16)		
			2,5+(0,75-2,5) / 1,5+(0,75-1,5)				6+(4-16) / 4+(2,5-16)			25+(4-25) / 16+(4-16)		
1 cable per clamp												
main connector	solid	AWG	18 - 10				16 - 10			12 - 10		
	flexible	AWG	18 - 10				14 - 4			10 - 0		
2 cables per clamp												
	solid	AWG	10+(16-10) / 12+(18-12)				10+(16-10) / 12+(18-12)			10+(12-10) / 12+12		
	flexible	AWG	14+(18-14) / 16+(18-16)				14+(18-14) / 16+(18-16)			1+(12-10) / 2+(8-12)		
			10+(14-10) / 12+(18-12)				4+(18-12) / 6+(18-8)			3+(12-8) / 4+(10-6)		
			14+(18-14) / 16+(18-16)				8+(18-8) / 10+(18-12)					
<b>Frequency of operations z</b>												
Contactors without thermal overload relay												
	without load	1/h	10000				7000			7000		
	AC3, I <sub>e</sub>	1/h	600				600			400		
	AC4, I <sub>e</sub>	1/h	120				120			120		
	DC3, I <sub>e</sub>	1/h	600				600			400		
<b>Mechanical life</b>												
AC operated	S x 10 <sup>6</sup>		10				10			10		
DC operated	S x 10 <sup>6</sup>		10				10			10		
DC-solenoid operated (KG3)	S x 10 <sup>6</sup>		50				50			-		
<b>Short time current</b>												
	10s-current	A	96	120	144	176	184	240	296	450	504	592
	120s-current	A	42	52	58	66	80	97	110	195	203	222
<b>Power loss per pole</b>												
contact resistance	at I <sub>e</sub> /AC3 400V	W	0,21	0,35	0,5	0,75	0,7	1,3	2	2,2	3,9	5,5
		mOhm	2,1	1,8	1,5	1,5	1,2	1,2	1,2	1	1	1
<b>Resistance to shock acc. to IEC 60068-2-27</b>												
Shock time 20ms sine-wave	NO	g	10	10	10	10	8	8	8	8	8	8
	NC	g	6	6	6	6	-	-	-	-	-	-

1) With reduced control voltage range 0,9 up to 1,0 x U<sub>s</sub> and with reduced rated current I<sub>e</sub>/AC1 according to I<sub>e</sub>/AC3

# Contactors

Data according to IEC 947-4-1, EN 60947-4-1, VDE 0660

Type	K3-90	K3-115	K3-116	K3-151	K3-176	K3-210	K3-260	K3-316	K3-450	K3-550	K3-700	K3-860	K3-1000	K3-1200		
°C	-40 bis +60 (+90) <sup>1)</sup>															
°C	-40 to +40															
°C	-25 to +60															
°C	-25 to +40															
°C	-50 to +90															
A	250	250	200	250	315	400	450	500	630	630	800	1000	1000	1250		
A	160	200	160	200	250	315	400	400	500	560	-	-	-	-		
A	100	125	125	160	200	250	315	-	-	-	-	-	-	-		
mm <sup>2</sup>																
mm <sup>2</sup>	0,5 - 16	10 - 16	busbar 18 x 4 screw M8		busbar 25 x 6 screw M10		busbar 30 x 5 screw M12		busbar 40 x 6 screw M12		busbar 50 x 8 screw M12		busbar 50 x 8 screw M14		busbar 50 x 10 screw 2 x M12	
mm <sup>2</sup>	0,5 - 70 (95)	25 - 95 (120)														
mm <sup>2</sup>	0,5 - 70	10 - 95														
mm <sup>2</sup>	0,5 - 95 + 10 - 120															
mm <sup>2</sup>	0,5 - 70 + 25 - 95															
AWG	18 - 10	-														
AWG	18 - 3/0	8 - 4/0														
AWG	-															
AWG	18 - 3/0 + 8 - 4/0															
1/h	3000		1200		1200		1200		1200		300		300		300	
1/h	300		240		150		50		25		20		-		-	
1/h	120		-		-		-		-		-		-		-	
1/h	300		-		-		-		-		-		-		-	
S x 10 <sup>6</sup>	5		10		5		5		5		5 <sup>3)</sup>		5 <sup>3)</sup>		-	
S x 10 <sup>6</sup>	5		10		5		5		5		5 <sup>3)</sup>		5 <sup>3)</sup>		-	
S x 10 <sup>6</sup>	-		-		-		-		-		-		-		-	
A	680	880	920	1200	1400	1800	2200	2600	3600	4400	5600	6900	8000	9600		
A	275	330	410	500	575	800	900	1000	1400	1750	2200	2600	3000	3600		
W	4,8	7,9	7,9	9	11	8	11	14,9	26,3	33,3	49	59,2	60	72		
mOhm	0,6	0,5	0,5	0,4	0,35	0,18	0,16	0,15	-	-	-	-	-	-		
g	7	7	-	-	-	-	-	-	-	-	-	-	-	-		
g	5	5	-	-	-	-	-	-	-	-	-	-	-	-		

1) With reduced control voltage range 0,9 up to 1,0 x U<sub>s</sub> and with reduced rated current I<sub>b</sub>/AC1 according to I<sub>b</sub>/AC3

2) With reduced control voltage range 1,0 x U<sub>s</sub> and with reduced rated current I<sub>b</sub>/AC1 according to I<sub>b</sub>/AC3

3) After each 1x10<sup>6</sup> operations magnetic core and built-in auxiliary contact block must be changed

# Contactors

## Data according to IEC 947-4-1, EN 60947-4-1, VDE 0660

Auxiliary Contacts			Type	K(G)3-10	K(G)3-14	K(G)3-18	K(G)3-22	K(G)3-24	K(G)3-32	K(G)3-40	K3-50	K3-62	K3-74
<b>Rated insulation voltage <math>U_i</math> <sup>1)</sup></b>			V~	690					-			-	
<b>Thermal rated current <math>I_{th}</math> to 690V</b>													
Ambient temperature			40°C A	10	(16) <sup>5)</sup>				-			-	
			60°C A	6	(12) <sup>5)</sup>				-			-	
<b>Utilization category AC15</b>													
Rated operational current $I_e$			220-240V A	3	(12) <sup>5)</sup>				-			-	
			380-415V A	2	(4) <sup>5)</sup>				-			-	
			440V A	1,6	(4) <sup>5)</sup>				-			-	
			500V A	1,2	(3) <sup>5)</sup>				-			-	
			660-690V A	0,6	(1) <sup>5)</sup>				-			-	
<b>Utilization category DC13</b>													
Rated operational current $I_e$			60V A	3,5	(8) <sup>5)</sup>				-			-	
			110V A	0,5	(1) <sup>5)</sup>				-			-	
			220V A	0,1					-			-	
<b>Short circuit protection</b> short-circuit current 1kA, contact welding not accepted max. fuse size			gL (gG) A	20	(25) <sup>5)</sup>				-			-	
For contactors with thermal overload relay the device with the smaller admissible control fuse (contactor or thermal overload relay) determines the fuse.													
<b>Control Circuit</b>													
<b>Power consumption of coils</b>													
AC operated			inrush VA	33-45				90-115				140-165	
			sealed VA	7-10				9-13				13-18	
			W	2,6-3				2,7-4				5,4-7	
DC operated			inrush W	75				140				200	
double winding coil			sealed W	2				2				6	
DC solenoid operated (KG3)			inrush W	3				4				-	
			sealed W	3				4				-	
<b>Operation range of coils</b> in multiples of control voltage $U_c$													
			AC operated	0,85-1,1				0,85-1,1				0,85-1,1	
			DC operated	0,8-1,1				0,8-1,1				0,8-1,1	
<b>Switching time</b> at control voltage $U_c \pm 10\%$ <sup>2) 3)</sup>													
AC operated			make time ms	8-16				10-25				12-28	
			release time ms	5-13				8-15				8-15	
			arc duration ms	10-15				10-15				10-15	
DC operated			make time ms	8-12				10-20				12-23	
double winding coil			release time ms	8-13				10-15				10-18	
			arc duration ms	10-15				10-15				10-15	
DC solenoid operated (KG3)			make time ms	65 - 85				65 - 85				-	
			release time ms	20 - 30 <sup>4)</sup>				20 - 30 <sup>4)</sup>				-	
			arc duration ms	10-15				10-15				-	
<b>Cable cross-section</b>													
Auxiliary connector			solid mm <sup>2</sup>	0,75-6				-				-	
			flexible mm <sup>2</sup>	1-4				-				-	
			flexible with multicore cable end mm <sup>2</sup>	0,75-4				-				-	
Magnet coil			solid mm <sup>2</sup>	0,75-2,5				0,75-2,5				0,75-2,5	
			flexible mm <sup>2</sup>	0,5-2,5				0,5-2,5				0,5-2,5	
			flexible with multicore cable end mm <sup>2</sup>	0,5-1,5				0,5-1,5				0,5-1,5	
Clamps per pole				2				2				2	
Auxiliary connector			solid AWG	18 - 10				-				-	
			flexible AWG	18 - 10				-				-	
Magnet coil			solid AWG	14 - 12				14 - 12				14 - 12	
			flexible AWG	18 - 12				18 - 12				18 - 12	
Clamps per pole				2				2				2	

1) Suitable for: earthed-neutral systems, overvoltage category I to IV, pollution degree 3 (standard-industry):  $U_{imp} = 8kV$ . Data for other conditions on request

2) Total breaking time = release time + arc duration

3) Values for delay of the release time of the make contact and the make time of the break contact will be increased, if magnet coils are protected against voltage peaks (varistor, RC-unit, diode-unit)

4) with built-in coil suppressor 5) for contactors KG3-...A.. only

# Contactors

Data according to IEC 947-4-1, EN 60947-4-1, VDE 0660

Type	K3-90	K3-115	K3-116	K3-151	K3-176	K3-210	K3-260	K3-316	K3-450	K3-550	K3-700	K3-860	K3-1000	K3-1200
V~	-	-	-	-	-	-	-	-	690	-	690	-	690	-
A	-	-	-	-	-	-	-	-	10	-	10	-	10	-
A	-	-	-	-	-	-	-	-	-	-	-	-	-	-
-	-	-	-	-	-	-	-	-	-	-	-	-	-	-
A	-	-	-	-	-	-	-	-	3	-	3	-	3	-
A	-	-	-	-	-	-	-	-	2	-	2	-	2	-
A	-	-	-	-	-	-	-	-	1,5	-	1,5	-	1,5	-
A	-	-	-	-	-	-	-	-	1,5	-	1,5	-	1,5	-
A	-	-	-	-	-	-	-	-	1	-	1	-	1	-
A	-	-	-	-	-	-	-	-	-	-	-	-	-	-
A	-	-	-	-	-	-	-	-	1	-	1	-	1	-
A	-	-	-	-	-	-	-	-	0,5	-	0,5	-	0,5	-
A	-	-	-	-	-	-	-	-	-	-	-	-	-	-
A	-	-	-	-	-	-	-	-	10	-	10	-	10	-
VA	165-220	-	-	350	-	-	360	-	800-950	-	1350-1600	-	2400	-
VA	2,5-5	-	-	5	-	-	5	-	9-11	-	21-25	-	70	-
W	2,5-5	-	-	5	-	-	5	-	9-11	-	21-25	-	70	-
W	250	-	-	350	-	-	360	-	700-850	-	1300-1550	-	2100	-
W	5	-	-	5	-	-	5	-	8-10	-	18-22	-	60	-
W	-	-	-	-	-	-	-	-	-	-	-	-	-	-
W	-	-	-	-	-	-	-	-	-	-	-	-	-	-
ms	0,85-1,1 0,8-1,1	-	-	0,85-1,1 0,85-1,1	-	-	0,85-1,1 0,85-1,1	-	0,85-1,1 0,85-1,1	-	0,85-1,1 0,85-1,1	-	0,85-1,1 0,85-1,1	-
ms	20-35	-	-	30-60	-	-	40-60	-	50-100	-	50-100	-	50-100	-
ms	35-50	-	-	30-80	-	-	15-45	-	150-200 / 500-1000 <sup>1)</sup>	-	25-50	-	25-50	-
ms	10-15	-	-	-	-	-	-	-	-	-	-	-	-	-
ms	20-35	-	-	30-60	-	-	40-60	-	-	-	-	-	-	-
ms	35-50	-	-	30-80	-	-	15-45	-	-	-	-	-	-	-
ms	10-15	-	-	-	-	-	-	-	-	-	-	-	-	-
ms	-	-	-	-	-	-	-	-	-	-	-	-	-	-
ms	-	-	-	-	-	-	-	-	-	-	-	-	-	-
ms	-	-	-	-	-	-	-	-	-	-	-	-	-	-
mm <sup>2</sup>	-	-	-	-	-	-	-	-	0,75-2,5	-	0,75-2,5	-	0,75-2,5	-
mm <sup>2</sup>	-	-	-	-	-	-	-	-	0,75-2,5	-	0,75-2,5	-	0,75-2,5	-
mm <sup>2</sup>	-	-	-	-	-	-	-	-	-	-	-	-	-	-
mm <sup>2</sup>	0,75-2,5	-	-	1-2,5	-	-	1-2,5	-	1-2,5	-	1-2,5	-	1-2,5	-
mm <sup>2</sup>	0,5-2,5	-	-	1-2,5	-	-	1-2,5	-	1-2,5	-	1-2,5	-	1-2,5	-
mm <sup>2</sup>	0,5-1,5	-	-	-	-	-	-	-	-	-	-	-	-	-
	2	-	-	2	-	-	2	-	2	-	2	-	2	-
AWG	-	-	-	-	-	-	-	-	16 - 12	-	16 - 12	-	16 - 12	-
AWG	-	-	-	-	-	-	-	-	16 - 12	-	16 - 12	-	16 - 12	-
AWG	14 - 12	-	-	16 - 12	-	-	16 - 12	-	16 - 12	-	16 - 12	-	16 - 12	-
AWG	18 - 12	-	-	16 - 12	-	-	16 - 12	-	16 - 12	-	16 - 12	-	16 - 12	-
	2	-	-	2	-	-	2	-	2	-	2	-	2	-

1) Normal or delayed drop is adjustable

Contactors, Motor-Starters  
Circuit Breakers  
Manual Motor-Starters  
Switches  
AC-Main Switches  
DC-Switch Disconnectors  
Push Buttons  
Representatives, Suppliers

# Contactors

## Data according to IEC 947-4-1, EN 60947-4-1, VDE 0660

Main Contacts	Type	K2-09	K2-12	K2-16	K2-23	K2-30	K2-37	K2-45	K2-60	K85	K110
<b>Rated insulation voltage <math>U_i</math></b> <sup>1)</sup>	V~	690	690	690	690	690	690	690	690	750	750
<b>Making capacity <math>I_{eff}</math></b> at $U_e = 690V\sim$	A	200	200	200	400	500	500	700	900	1100	1200
<b>Breaking capacity <math>I_{eff}</math></b> 400V~	A	180	180	200	380	400	400	600	800	950	1100
K2-09 to K2-16 $\cos\phi = 0,65$ 500V AC	A	150	150	180	300	370	370	500	700	850	1100
K2-23 to K3-1200 $\cos\phi = 0,35$ 690V AC	A	100	100	150	260	340	340	400	500	600	600
	A	-	-	-	-	-	-	-	-	-	-
<b>Utilization category AC1</b>											
<b>Switching of resistive load</b>											
Rated operational current $I_e (=I_{th})$ at 40°C, open	<b>A</b>	<b>25</b>	<b>25</b>	<b>25</b>	<b>45</b>	<b>50</b>	<b>50</b>	<b>80</b>	<b>100</b>	<b>150</b>	<b>170</b>
Rated operational power of three-phase resistive loads 50-60Hz, $\cos\phi = 1$	220V kW	9,5	9,5	9,5	17	19	19	30	38	57	64
	230V kW	10	10	10	18	20	20	31,5	40	59	67
	240V kW	10,5	10,5	10,5	18,5	20,5	20,5	33	41	62	70
	380V kW	16,5	16,5	16,5	29,5	33	33	52	65	98	111
	400V kW	17,5	17,5	17,5	31	34,5	34,5	55	69	103	117
	415V kW	18	18	18	32	36	36	57	71	107	122
	440V kW	19	19	19	34	38	38	61	76	114	129
	500V kW	21,5	21,5	21,5	39	43	43	69	86	130	147
	660V kW	28,5	28,5	28,5	51	57	57	91	114	171	194
	690V kW	29,5	29,5	29,5	53,5	60	60	95	119	179	203
Rated operational current $I_e (=I_{th})$ at 60°C, enclosed	A	20	25	25	35	40	40	63	80	100	125
Rated operational power of three-phase resistive loads 50-60Hz, $\cos\phi = 1$	220V kW	7,5	9,5	9,5	13	15	15	24	30	38	47
	230V kW	8	10	10	13,5	16	16	25	31,5	40	49
	240V kW	8	10,5	10,5	14,5	16,5	16,5	26	33	41	52
	380V kW	13	16,5	16,5	23	26	26	41	52	65	82
	400V kW	13,5	17,5	17,5	24	27,5	27,5	43	55	69	86
	415V kW	14	18	18	25	28,5	28,5	45	57	71	89
	440V kW	15	19	19	26,5	30	30	48	61	71	95
	500V kW	17	21,5	21,5	30	34	34	54	69	86	116
	660V kW	22,5	28,5	28,5	40	45	45	72	91	114	142
	690V kW	23,5	29,5	29,5	42	48	48	75	95	119	149
Minimum cross-section of conductor at load with $I_e (=I_{th})$	mm <sup>2</sup>	4	4	4	10	10	10	25	35	50	70
<b>Utilization category AC2 and AC3</b>											
<b>Switching of three-phase motors</b>											
Rated operational current $I_e$ open and enclosed	220V A	12	15	18	23	30	37	45	63	85	110
	230V A	11,5	14,5	17,5	23	30	37	45	61	85	110
	240V A	11	14	17	23	30	37	45	60	85	110
	<b>380-400V A</b>	<b>10</b>	<b>12</b>	<b>16</b>	<b>23</b>	<b>30</b>	<b>37</b>	<b>45</b>	<b>60</b>	<b>85</b>	<b>110</b>
	415-440V A	9	12	16	23	30	37	45	60	85	110
	500V A	9	12	16	23	30	30	45	55	85	110
	660V A	7	9	9	17,5	21	21	33	42	60	60
	690V A	6,5	8,5	8,5	17	20	20	31	40	58	58
Rated operational power of three-phase motors 50-60Hz	220-230V kW	3	4	5	6	8,5	11	12,5	18,5	25	33
	240V kW	3	4	5	7	9	11,5	13,5	19	27	35
	<b>380-400V kW</b>	<b>4</b>	<b>5,5</b>	<b>7,5</b>	<b>11</b>	<b>15</b>	<b>18,5</b>	<b>22</b>	<b>30</b>	<b>45</b>	<b>55</b>
	415V kW	4,5	6	8,5	12	16	20	24	33	49	63
	440V kW	4,5	6	8,5	12	16	20	24	33	49	63
	500V kW	5,5	7,5	10	15	18,5	18,5	30	37	55	55
	660-690V kW	5,5	7,5	7,5	15	18,5	18,5	30	37	55	55

1) Suitable at 690V for: earthed-neutral systems, overvoltage category I to IV, pollution degree 3 (standard-industry):  $U_{imp} = 8kV$ .  
Data for other conditions on request.

# Contactors

Data according to IEC 947-4-1, EN 60947-4-1, VDE 0660

Main Contacts	Type	K2-09	K2-12	K2-16	K2-23	K2-30	K2-37	K2-45	K2-60	K85	K110
<b>Utilization category AC4</b>											
<b>Switching of squirrel cage motors, inching</b>											
Rated operational current $I_e$	220V A	12	15	16	23	30	37	45	63	85	98
open and enclosed	230V A	11,5	14,5	16	23	30	37	45	61	85	98
	240V A	11	14	16	23	30	37	45	60	85	98
	<b>380-400V A</b>	<b>10</b>	<b>12</b>	<b>16</b>	<b>23</b>	<b>30</b>	<b>37</b>	<b>45</b>	<b>60</b>	<b>85</b>	<b>85</b>
	415V A	9	12	16	21	28	37	45	60	85	85
	440V A	9	12	16	21	28	37	45	60	85	85
	500V A	9	12	16	17	23	23	45	55	85	85
	660V A	7	9	9	13	17	17	33	42	60	60
	690V A	6,5	8,5	8,5	12,5	16,5	16,5	31	40	57,5	57,5
Rated operational power of three-phase motors	220-230V kW	3	4	5	6	8,5	11	12,5	18,5	25	30
50-60Hz	240V kW	3	4	5	7	9	11,5	13,5	19	27	32
	<b>380-400V kW</b>	<b>4</b>	<b>5,5</b>	<b>7,5</b>	<b>11</b>	<b>15</b>	<b>18,5</b>	<b>22</b>	<b>30</b>	<b>45</b>	<b>45</b>
	415-440V kW	4,5	6	8,5	11	15	20	24	33	49	49
	500V kW	5,5	7,5	10	11	15	15	30	37	55	55
	660-690V kW	5,5	7,5	7,5	11	15	15	30	37	55	55
<b>Utilization category AC5a</b>											
<b>Switching of gas discharge lamps</b>											
Rated operational current $I_e$ per pole at 220/230V											
Fluorescent lamps, uncompensated	A	20	20	20	35	40	40	65	85	100	120
Fluorescent lamps, compensated	A	7	9	9	18	22	22	30	40	55	70
Fluorescent lamps, dual-connection	A	22,5	22,5	22,5	41	45	45	72	90	112	144
Metal-halide lamps <sup>1)</sup> , uncompensated	A	12	15	15	28	30	30	50	62	85	90
Metal-halide lamps <sup>1)</sup> , compensated	A	7	9	9	18	22	22	30	40	55	70
Mercury-vapour lamps <sup>2)</sup> , uncompensated	A	22,5	25	25	41	45	45	72	90	112	144
Mercury-vapour lamps <sup>2)</sup> , compensated	A	7	9	9	18	22	22	30	40	55	70
Mixed light lamps <sup>3)</sup>	A	20	20	20	35	40	40	65	85	100	120
<b>Utilization category AC5b</b>											
<b>Switching of incandescent lamps<sup>4)</sup></b>											
Rated operational current $I_e$ per pole at 220/230V	A	12,5	12,5	12,5	25	31	31	43	56	69	75
<b>Utilization category AC6a</b>											
<b>Transformer primary switching</b>											
at inrush	n	30	30	30	30	30	30	30	30	30	30
Rated operational current $I_e$	400V A	4,5	5,5	7,5	10,5	13,5	13,5	20	27	38	50
Rated operational power dependent on inrush n	220-230V kVA	1,8	2,2	3	4,2	5,4	5,4	8	10,7	15	20
	240V kVA	1,9	2,3	3,1	4,3	5,6	5,6	8,3	11,2	15,5	20,5
	380-400V kVA	3,1	3,8	5,2	7,3	9,3	9,3	13,5	18,5	26	34
For different inrush-factors x use the following formula: $P_x = P_n \cdot (n/x)$	415-440V kVA	3,4	4,2	5,7	8	10,2	10,2	15	20,5	29	38
	500V kVA	3,9	4,8	6,5	9	11,5	11,5	17	23	33	43
	660-690V kVA	5,4	6,5	9	12,5	16	16	24	32	45	60
<b>Utilization category DC1</b>											
<b>Switching of resistive load</b>											
Time constant $L/R \leq 1ms$	1 pole 24V A	20	25	25	45	50	50	80	100	150	170
Rated operational current $I_e$	60V A	20	25	25	45	50	50	80	100	150	170
	110V A	6	6	6	10	10	10	12	12	20	25
	220V A	0,8	0,8	0,8	1,4	1,4	1,4	1,4	1,4	2	2,5
	2 poles in series 24V A				45	50	50				
	60V A				45	50	50				
	110V A				45	50	50				
	220V A				10	10	10				
	3 poles in series 24V A	20	25	25	45	50	50	80	100	150	170
	60V A	20	25	25	45	50	50	80	100	150	170
	110V A	20	25	25	45	50	50	80	100	150	170
	220V A	16	20	20	30	35	35	63	80	100	160

1) Metal halide lamps and sodium-vapour lamps (high- and low-pressure lamps)

2) High-pressure lamps

3) Blended lamps, containing a mercury high-pressure unit and a tungsten helix in a fluorescent glass bulb (daylight lamps)

4) Current inrush approx.  $16 \times I_e$

5) With central compensation pay attention to the current inrush (capacitor switching contactors)



# Contactors

## Data according to IEC 947-4-1, EN 60947-4-1, VDE 0660

Main Contacts			Type	K2-09	K2-12	K2-16	K2-23	K2-30	K2-37	K2-45	K2-60	K85	K110
<b>Utilization category DC3 and DC5</b>													
<b>Switching of shunt motors and series motors</b>													
Time constant L/R ≤15ms	1 pole	24V	A	20	25	25	45	50	50	80	100	150	170
Rated operational current I <sub>e</sub>		60V	A	6	6	6	30	30	30	60	60	85	110
		110V	A	1,2	1,2	1,2	1,8	1,8	1,8	1,8	1,8	2	2,5
		220V	A	0,2	0,2	0,2	0,2	0,2	0,2	0,25	0,25	0,5	0,5
		2 poles in series	24V	A				45	50	50			
		60V	A				45	50	50				
		110V	A				30	30	30				
		220V	A				1,8	1,8	1,8				
	3 poles in series	24V	A	20	25	25	45	50	50	80	100	150	170
		60V	A	20	25	25	40	40	40	80	80	100	110
		110V	A	20	20	20	40	40	40	80	80	100	110
		220V	A	2,5	2,5	2,5	4	4	4	5	5	7	8
<b>Maximum ambient temperature</b>													
Operation	open	°C		-40 to +60 (+90) <sup>1)</sup>									
	enclosed	°C		-40 to +40									
with thermal overload relay	open	°C		-25 to +60									
	enclosed	°C		-25 to +40									
Storage		°C		-50 to +90									
<b>Short circuit protection</b>													
for contactors without thermal overload relay													
Coordination-type "1" according to IEC 947-4-1													
Contact welding without hazard of persons													
max. fuse size	gL (gG)	A		63	63	63	80	80	80	160	160	250	250
Coordination-type "2" according to IEC 947-4-1													
Light contact welding accepted													
max. fuse size	gL (gG)	A		25	35	35	50	50	50	100	125	160	200
Contact welding not accepted													
max. fuse size	gL (gG)	A		16	16	16	25	35	35	50	63	100	125
For contactors with thermal overload relay the device with the smaller admissible backup fuse (contactor or thermal overload relay) determines the fuse size.													
<b>Cable cross-sections</b>													
for contactors without thermal overload relay													
main connector	solid or stranded	mm <sup>2</sup>		0,75 - 4			1,5-10 + 1,5-6			4 - 35 <sup>2)</sup>		10 - 70 <sup>2)</sup>	
	flexible	mm <sup>2</sup>		0,75 - 2,5			1,5-6 + 1,5-4			6 - 25 <sup>2)</sup>		10 - 70 <sup>2)</sup>	
Cables per clamp	flexible with multicore cable end	mm <sup>2</sup>		0,5 - 2,5			1,5-6 + 1,5-4			4 - 25		10 - 35	
				2			1+1			1		1	
main connector	solid	AWG		14 - 10			14 - 10 + 14 - 10			10		10	
	flexible	AWG		18 - 10			14 - 8 + 14 - 10			10 - 2		6 - 0	
Cables per clamp				2			1+1			1		1	
<b>Frequency of operations z</b>													
Contactors without thermal overload relay													
	without load	1/h		10000			7000			7000		3000	
	AC3, I <sub>e</sub>	1/h		600			600			400		300	
	AC4, I <sub>e</sub>	1/h		120			120			120		120	
	DC3, I <sub>e</sub>	1/h		600			600			400		300	
<b>Mechanical life</b>													
AC operated		S x 10 <sup>6</sup>		10			10			10		5	
DC operated with economy resistor		S x 10 <sup>6</sup>		10			10			10		5	
<b>Short time current</b>													
	10s-current	A		96	120	144	184	240	296	360	504	680	880
<b>Power loss per pole</b>													
	at I <sub>e</sub> /AC3 400V	W		0,21	0,26	0,4	0,63	1,1	1,7	1,8	3,6	4,3	6,0
<b>Resistance to shock acc. to IEC 68-2-27</b>													
Shock time 20ms sine-wave	NO	g		10	10	10	8	8	8	8	8	7	7
	NC	g		6	6	6	5	5	5	-	-	5	5

1) With reduced control voltage range 0,9 up to 1,0 x U<sub>s</sub> and with reduced rated current I<sub>e</sub> /AC1 according to I<sub>e</sub> /AC3

2) Maximum cable cross-section with prepared conductor

# Contactors

Data according to IEC 947-4-1, EN 60947-4-1, VDE 0660

Auxiliary Contacts	Type	K2-09	K2-12	K2-16	K2-23	K2-30	K2-37	K2-45	K2-60	K85	K110
<b>Rated insulation voltage <math>U_i</math> <sup>1)</sup></b>	V AC		690			690			-		690
<b>Thermal rated current <math>I_{th}</math> to 690V</b>											
Ambient temperature	40°C A		16			16			-		16
	60°C A		12			12			-		12
<b>Utilization category AC15</b>											
Rated operational current $I_e$	220-240V A		12			12			-		12
	380-415V A		4			4			-		6
	440V A		4			4			-		6
	500V A		3			3			-		4
	660-690V A		1			1			-		2
<b>Utilization category DC13</b>											
Rated operational current $I_e$	60V A		8			8			-		8
	110V A		1			1			-		1
	220V A		0,1			0,1			-		0,1
<b>Short circuit protection</b> short-circuit current 1kA, contact welding not accepted max. fuse size gL (gG) A For contactors with thermal overload relay the device with the smaller admissible control fuse (contactor or thermal overload relay) determines the fuse.			25			-			-		25
<b>Control Circuit</b>											
<b>Power consumption of coils</b>											
AC operated	inrush VA		33-45			90-115		140-165		280-350	350-420
	sealed VA		7-10			9-13		13-18		16-23	23-29
	W		2,6-3			2,7-4		5,4-7		4-6	6-7,3
DC operated	inrush W		75			140		200		170	320
with economic circuit	sealed W		2			2		6		2	4
<b>Operation range of coils</b> in multiples of control voltage $U_s$											
	AC operated		0,85-1,1			0,85-1,1		0,85-1,1		0,85-1,1	0,85-1,1
	DC operated		0,8-1,1			0,8-1,1		0,8-1,1		0,8-1,1	0,8-1,1
<b>Switching time</b> at control voltage $U_s \pm 10\%$ <sup>2) 3)</sup>											
AC operated	make time ms		8-16			10-25		12-28		13-30	13-30
	release time ms		5-13			8-15		8-15		8-15	8-15
	arc duration ms		10-15			10-15		10-15		10-15	10-15
DC operated	make time ms		8-12			10-20		12-23		20-30	20-30
with AC magnet system	release time ms		8-13			10-15		10-18		10-18	10-18
	arc duration ms		10-15			10-15		10-15		10-15	10-15
<b>Cable cross-section</b>											
Auxiliary connector	solid mm <sup>2</sup>		0,75-4			-		-		0,75-2,5	0,75-2,5
	flexible mm <sup>2</sup>		0,75-2,5			-		-		0,75-2,5	0,75-2,5
	flexible with multicore cable end mm <sup>2</sup>		0,5-2,5			-		-		0,5-1,5	0,5-1,5
Magnet coil	solid mm <sup>2</sup>		0,75-2,5			0,75-2,5		0,75-2,5		0,75-2,5	0,75-2,5
	flexible mm <sup>2</sup>		0,5-2,5			0,5-2,5		0,5-2,5		0,5-2,5	0,5-2,5
	flexible with multicore cable end mm <sup>2</sup>		0,5-1,5			0,5-1,5		0,5-1,5		0,5-1,5	0,5-1,5
Clamps per pole			2			2		2		2	2

1) Suitable for: earthed-neutral systems, overvoltage category I to IV, pollution degree 3 (standard-industry):  $U_{imp} = 8kV$ . Data for other conditions on request

2) Total breaking time = release time + arc duration

3) Values for delay of the release time of the make contact and the make time of the break contact will be increased, if magnet coils are protected against voltage peaks (varistor, RC-unit, diode-unit)

# Contactors for North America

## Data according to UL508

Main Contacts (cULus)		Type	K(G)3-10	K(G)3-14	K(G)3-18	K(G)3-22	K(G)3-24	K(G)3-32	K(G)3-40	K3-50	K3-62	K3-74
Rated operational current "General Use"		A	25	25	30	30	50	65	80	110	120	130
<b>Motor DOL 3-phase</b> at 60Hz												
Rated operational current	600V	A	10	14	18	22	22	27	34	44	52	66
Rated operational power	110-120V	hp	1½	2	2	3	5	5	7½	10	10	10
	200V	hp	3	3	5	5	7½	10	10	15	20	25
	220-240V	hp	3	3	7½	7½	10	10	15	20	25	30
	277V	hp	3	5	7½	7½	7½	10	15	20	25	30
	380-415V	hp	5	5	10	10	10	15	20	25	30	40
	440-480V	hp	5	7½	10	15	15	20	25	30	40	50
	550-600V	hp	7½	10	15	20	20	25	30	40	50	50
<b>Motor DOL 1-phase</b> at 60Hz												
Rated operational current	600V	A	10	14	18	22	22	27	34	44	52	66
Rated operational power of AC motors at 60Hz (1ph)	110-120V	hp	½	¾	1	1½	1½	2	3	3	5	7½
	200V	hp	1	1,5	2	3	3	5	7½	7½	10	15
	220-240V	hp	1½	2	3	3	5	5	7½	10	15	15
	277V	hp	2	3	3	5	5	7½	10	10	15	15
	380-415V	hp	3	3	5	5	5	7½	10	15	20	20
	440-480V	hp	3	5	5	7½	7½	10	15	20	25	25
	550-600V	hp	3	5	7½	10	10	15	20	25	30	30
<b>Motor DOL 3-phase</b> according to ANSI A17.5												
Rated operational current	600V	A	-	-	-	-	15	22	-	27	37	-
Rated operational power of 3-phase motors for elevators (500.000 operations)	110-120V	hp	-	-	-	-	2	3	-	3	5	-
	200V	hp	-	-	-	-	3	5	-	7½	10	-
	220-240V	hp	-	-	-	-	5	7½	-	7½	10	-
	440-480V	hp	-	-	-	-	10	15	-	20	25	-
	550-600V	hp	-	-	-	-	10	20	-	25	30	-
Rated current 2 series contacts	600V	A	-	-	-	-	22	27	-	44	52	66
Fuse Class RK5 / Short-circuit current		A/kA	50/5	50/5	70/5	90/5	90/5	125/5	175/5	200/5	250/5	300/5
Fuse Class T / Short-circuit current		A/kA	45/100	50/100	70/100	90/100	110/100	150/100	150/100	175/100	175/100	175/100
Rated voltage		V	600	600	600	600	600	600	600	600	600	600
<b>Auxiliary Contacts (cULus)</b>			A600	A600	A600	A600	-	-	-	-	-	-

Main Contacts (cULus)		Type	K2-09	K2-12	K2-16	K2-23	K2-30	K2-45	K2-60	K85	K110
Rated operational current "General Use"		A	25	25	25	40	40	72	90	125	150
<b>Motor DOL 3-phase</b> at 60Hz											
Rated operational power	110-120V	hp	1½	2	2	3	5	-	-	15	-
	200V	hp	2	3	3	5	7½	10	15	-	30
	220-240V	hp	3	3	5	7½	10	15	20	35	40
	440-480V	hp	5	7½	10	15	20	30	40	65	75
	550-600V	hp	7½	10	15	20	25	40	50	85	100
<b>Motor DOL 1-phase</b> at 60Hz											
Rated operational power	110-120V	hp	½	¾	1	1½	2	3	5	8	10
	200V	hp	1	2	2	3	3	5	7½	-	20
	220-240V	hp	1½	2	3	3	5	7½	10	20	20
Fuse / Short-circuit current		A/kA	30/5	40/5	50/5	60/5	110/5	175/5	175/5	-	300/5
Rated voltage		V	600	600	600	600	600	600	600	600	600
<b>Auxiliary Contacts (cULus)</b>			A600	A600	A600	A600	A600	-	-	A600	A600

# Contactors for North America

## Data according to UL508

Type	K3-90	K3-115	K3-116	K3-151	K3-176	K3-210	K3-260	K3-316	K3-450	K3-550	K3-700	K3-860	K3-1000	K3-1200
A	160	200	150	180	220	250	300	350	420	520	700	810	-	1215
A	85	99		125	150	190	240	300	300	400	550	700	-	1000
hp	15	20	-	-	-	-	-	-	-	-	-	-	-	-
hp	25	35	30	40	50	60	75	100	125	150	200	250	-	450
hp	35	40	40	50	60	75	100	125	125	150	250	300	-	450
hp	-	-	-	-	-	-	-	-	-	-	-	-	-	-
hp	50	60	-	-	-	-	-	-	-	-	-	-	-	-
hp	65	75	75	100	125	150	200	250	250	350	500	600	-	900
hp	85	100	100	125	150	200	250	300	250	350	500	600	-	900
A	86	103		125	150	-	-	-	-	-	-	-	-	-
hp	8	10	10	15	25	-	-	-	-	-	-	-	-	-
hp	15	20	20	-	-	-	-	-	-	-	-	-	-	-
hp	20	25	-	25	30	40	50	50	-	-	-	-	-	-
hp	20	25	-	-	-	-	-	-	-	-	-	-	-	-
hp	30	40	-	-	-	-	-	-	-	-	-	-	-	-
hp	40	50	-	-	-	-	-	-	-	-	-	-	-	-
hp	50	60	-	-	-	-	-	-	-	-	-	-	-	-
A	-	-	-	-	-	-	-	-	-	-	-	-	-	-
hp	-	-	-	-	-	-	-	-	-	-	-	-	-	-
hp	-	-	-	-	-	-	-	-	-	-	-	-	-	-
hp	-	-	-	-	-	-	-	-	-	-	-	-	-	-
hp	-	-	-	-	-	-	-	-	-	-	-	-	-	-
A	-	-	-	-	-	-	-	-	-	-	-	-	-	-
A/kA	300/10	300/10	225/10	300/10	350/10	400/18	500/18	500/18	1200/18	1200/18	2000/30	2000/30	-	2000/42
A/kA	300/100 <sup>3)</sup>	300/100 <sup>3)</sup>	-	-	-	-	-	-	-	-	-	-	-	-
V	600	600	600	600	600	600	600	600	600	600	600	600	-	600
	-	-	-	-	-	-	-	-	A600	A600	A600	A600	-	A600

Main Contacts (cULus)	Type	K3-18NK	K3-18NBK	K3-24K	K3-32K	K3-50K	K3-62K	K3-74K	K3-90K	K3-115K	
Rated operational power of 3-phase cap. banks 110-120V at 60Hz (3ph)	200V	kVAr	0-3,5	0-3,5	3-5,5	3-7	6,5-10	6,5-15	6,5-18 <sup>1)</sup>	10-24	10-28 <sup>2)</sup>
	220-240V	kVAr	0-6	0-6	4,5-10	4,5-12,5	10-16,7	10-25	10-32 <sup>1)</sup>	17-40	17-46 <sup>2)</sup>
		kVAr	0-7	0-7	5,5-11	5,5-15	12,5-20	12,5-30	12,5-36 <sup>1)</sup>	20-47	20-56 <sup>2)</sup>
	440-480V	kVAr	0-15	0-15	11,5-25	11,5-30	25-40	25-60	25-72 <sup>1)</sup>	40-95	40-114 <sup>2)</sup>
550-600V	kVAr	0-18	0-18	14,5-30	14,5-35	31-50	31-75	31-90 <sup>1)</sup>	50-120	50-143 <sup>2)</sup>	
Fuse Class RK5 / Short-circuit current	A/kA	70/5	70/5	90/5	125/5	200/5	250/5	300/5	300/10	300/10	
Fuse Class T / Short-circuit current	A/kA	80/100	80/100	110/100	150/100	175/100	175/100	175/100	300/100 <sup>3)</sup>	300/100 <sup>3)</sup>	
Rated voltage	V	600	600	600	600	600	600	600	600	600	
<b>Auxiliary Contacts (cULus)</b>		A600	A600	-	-	-	-	-	-	-	

1) Consider the max. thermal current of the contactor K3-74A: I<sub>th</sub> 130A

2) Consider the min. cross-section of conductor at max. load

3) Class T and Class RK1

# Contactors

## Data according to IEC 947-4-1, EN 60947-4-1, VDE 0660

### Contact Life

For selection of the suitable contactor-type according to supply voltage, power rating and application (utilization category AC1, AC3 or AC4) use contact life characteristic diagram.

For the most common supply voltages four scales of power ratings  $P_n$  are provided for each utilization category.

Select contactor-type according to utilization category **AC3** (breaking current  $I_a = I_e$ ) using the **motor rating** scales to the right, according to utilization category **AC4** (breaking current  $I_a = 6 \times I_e$ ) using the **motor rating** scales to the left. <sup>1)</sup>

Select contactor-type according to utilization category **AC1** (breaking current  $I_a = I_e/AC1$ ) using the **breaking current** scale. <sup>1)</sup>

For contactors frequently used under AC3/AC4-mixed service conditions calculate contact life with the formula:

$$M = \frac{AC3}{1 + \frac{\%AC4}{100} \times \left( \frac{AC3}{AC4} - 1 \right)}$$

M = Contact life (switching cycles) for AC3/AC4-mixed operations  
 AC3 = Contact life (switching cycles) for AC3 operations (normal switching conditions). Breaking current  $I_a =$  rated motor current  $I_e$ .  
 AC4 = Contact life (switching cycles) for AC4 operations (inching). Breaking current  $I_a =$  multiples of rated motor current  $I_e$ .  
 %AC4 = Percents of AC4-operations related to the total cycles.

#### Motor Rating

##### $P_n = AC4$

660/ 500V 380/ 220/  
690V 400V 230V

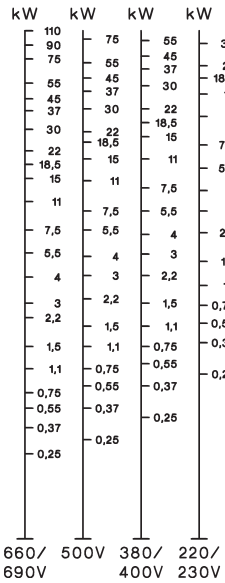

#### Motor Rating

##### $P_n = AC3$

660/ 500V 380/ 220/  
690V 400V 230V

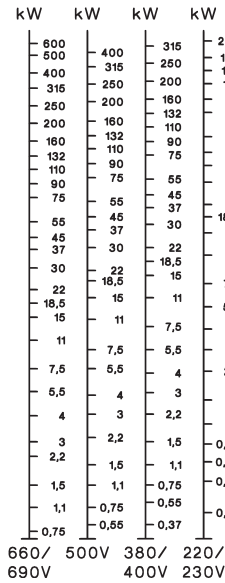

#### Breaking Current

##### $I_a (= I_e = AC1)$

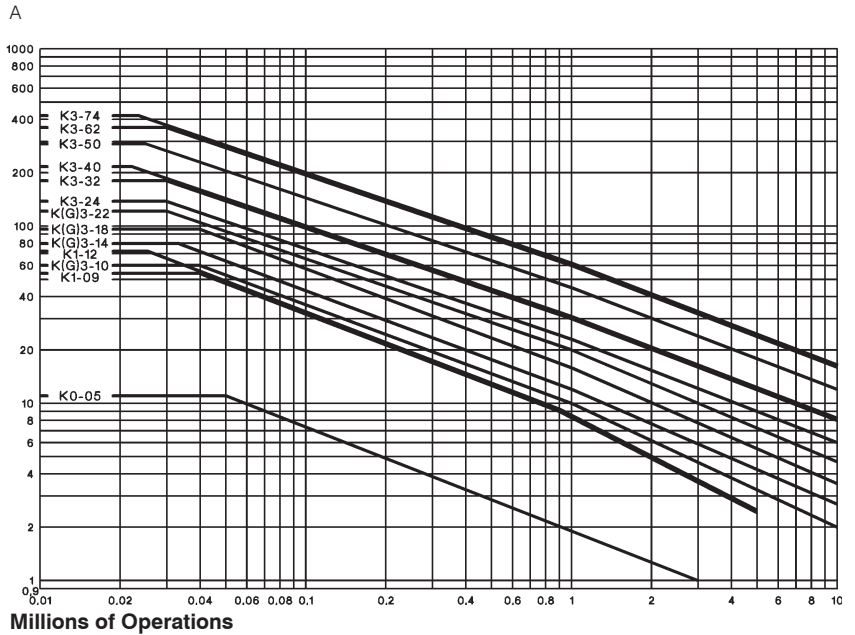

#### Motor Rating

##### $P_n = AC4$

660/ 500V 380/ 220/  
690V 400V 230V

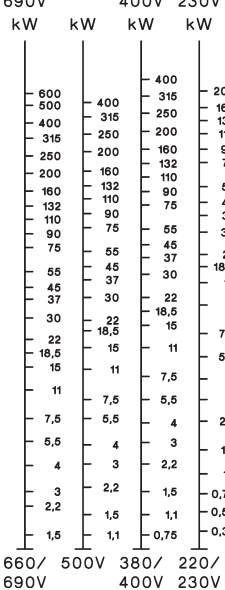

#### Motor Rating

##### $P_n = AC3$

660/ 500V 380/ 220/  
690V 400V 230V

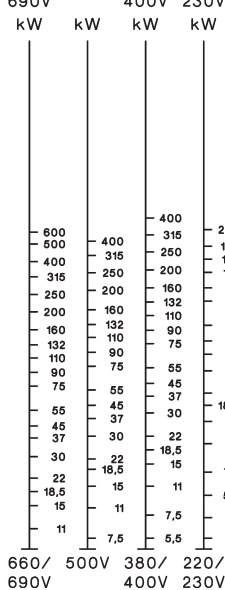

#### Breaking Current

##### $I_a (= I_e = AC1)$

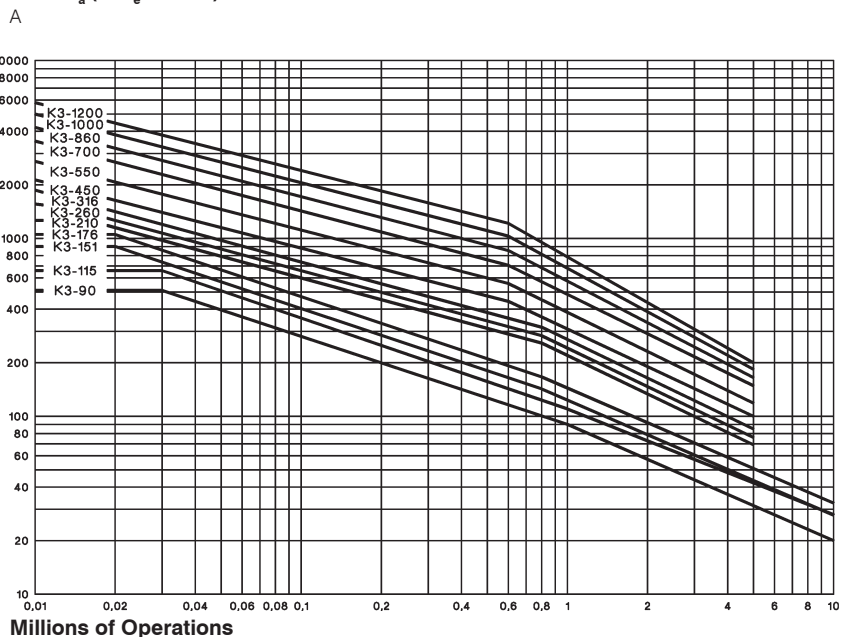

1) Pay attention to the approved rated values of the selected contactor according to the national approvals

# Contactors

## Utilization Categories

For easier choice of devices and in order to make the comparison of different products simpler are utilization categories for contactors and motor-starters according to IEC 947-4-1 and VDE 0660 Part

102, for control circuit devices and switching elements according to IEC 947-5-1 and VDE 0660 Part 200 determined. The table offers different utilization categories, typical applications and assorted test conditions.

Type of current	Category	Typical applications	Rated operational current	Test conditions for the number of on-load operating cycles						Test conditions for making and breaking capacities					
				Make			Break			Make			Break		
				$I/I_e$	$U/U_e$	cosφ	$I_c/I_e$	$U_c/U_e$	cosφ	$I/I_e$	$U/U_e$	cosφ	$I_c/I_e$	$U_c/U_e$	cosφ
Alternating Current	<b>AC1</b>	Non-inductive or slightly inductive loads resistance furnaces	all values	1	1	0,95	1	1	0,95	1,5	1,05	0,8	1,5	1,05	0,8
	<b>AC2</b>	Slip-ring motors: starting, switching off	all values	2,5	1	0,65	2,5	1	0,65	4	1,05	0,65	4	1,05	0,65
	<b>AC3</b>	Squirrel-cage motors: starting, switching off motors during running	$I_e < 17A$ $I_e > 17A$ $I_e > 100A$	6 6 6	1 1 1	0,65 0,35 0,35	1 1 1	0,17 0,17 0,17	0,65 0,35 0,35	10 10 10	1,05 1,05 1,05	0,45 0,45 0,35	8 8 8	1,05 1,05 1,05	0,45 0,45 0,35
	<b>AC4</b>	Squirrel-cage motors: starting, plugging, inching	$I_e < 17A$ $I_e > 17A$ $I_e > 100A$	6 6 6	1 1 1	0,65 0,35 0,35	6 6 6	1 1 1	0,65 0,35 0,35	12 12 12	1,05 1,05 1,05	0,45 0,45 0,35	10 10 10	1,05 1,05 1,05	0,45 0,45 0,35
	<b>AC5a</b>	Switching of electric discharge lamp controls	all values	-	-	-	-	-	-	3	1,05	0,45	3	1,05	0,45
	<b>AC5b</b>	Switching of incandescent lamps	all values	-	-	-	-	-	-	1,5	1,05	<sup>1)</sup>	4	1,05	<sup>1)</sup>
	<b>AC6a</b>	Switching of transformers	$I_e < 100A$ $I_e > 100A$	-	-	-	-	-	-	4,5 4,5	1,05 1,05	0,45 0,35	3,6 3,6	1,05 1,05	0,45 0,35
	<b>AC6b</b>	Switching of capacitors	-	-	-	-	-	-	-	<sup>2)</sup>			<sup>2)</sup>		
	<b>AC7a</b>	Slightly inductive loads in household appliances and similar applications	all values	-	-	-	-	-	-	1,5	1,05	0,8	1,5	1,05	0,8
	<b>AC7b</b>	Motor loads for household applications	$I_e < 100A$ $I_e > 100A$	-	-	-	-	-	-	8 8	1,05 1,05	0,45 0,35	6 6	1,05 1,05	0,45 0,35
	<b>AC8a</b>	Hermetic refrigerant compressor motor control with manual resetting of overload releases	$I_e < 100A$ $I_e > 100A$	-	-	-	-	-	-	6 6	1,05 1,05	0,45 0,35	6 6	1,05 1,05	0,45 0,35
	<b>AC8b</b>	Hermetic refrigerant compressor motor control with automatic resetting of overload releases	$I_e < 100A$ $I_e > 100A$	-	-	-	-	-	-	6 6	1,05 1,05	0,45 0,35	6 6	1,05 1,05	0,45 0,35
	<b>AC12</b>	Control of resistive loads and solid state loads with isolation by opto couplers	all values	-	-	-	-	-	-	1	1	0,9	1	1	0,9
	<b>AC13</b>	Control of solid state loads with transformer isolation	all values	-	-	-	-	-	-	10	1,1	0,65	1,1	1,1	0,65
	<b>AC14</b>	Control of small electromagnetic loads ( $\leq 72VA$ )	-	-	-	-	-	-	-	6	1,1	0,7	6	1,1	0,7
<b>AC15</b>	Control of electromagnetic load ( $> 72VA$ )	-	10	1	0,7	1	1	0,4	10	1,1	0,3	10	1,1	0,3	
Direct Current	<b>DC1</b>	Non-inductive or slightly inductive loads resistance furnaces	all values	1	1	1	1	1	1	1,5	1,05	1	1,5	1,05	1
	<b>DC3</b>	Shunt-motors: starting, plugging, inching dynamic braking of d.c. motors	all values	2,5	1	2	2,5	1	2	4	1,05	2,5	4	1,05	2,5
	<b>DC5</b>	Series-motors: starting, plugging, inching dynamic braking of d.c. motors	all values	2,5	1	7,5	2,5	1	7,5	4	1,05	15	4	1,05	15
	<b>DC6</b>	Switching of incandescent lamps	all values	-	-	-	-	-	-	1,5	1,05	<sup>1)</sup>	4	1,05	<sup>1)</sup>
	<b>DC12</b>	Control of resistive loads and solid state loads with isolation by opto couplers	all values	-	-	-	-	-	-	1	1	1	1	1	1
	<b>DC13</b>	Control of electromagnets	all values	1	1	$\leq 300$	1	1	$\leq 300$	1,1	1,1	$\leq 300$	1,1	1,1	$\leq 300$
	<b>DC14</b>	Control of electromagnetic loads having economy resistors in circuit	all values	-	-	-	-	-	-	10	1,1	15	10	1,1	15

1) Test with incandescent lamps

2) Test conditions according to standard

## Accessories

### Data according to IEC 947-5-1, EN 60947-5-1, VDE 0660

Type		HN	HTN	HA	HB	HKT HKA	HKF HKB	K2-DK K2-SK	K2-TP	K2-L <sup>2)</sup>	
<b>Rated insulation voltage U<sub>i</sub><sup>1)</sup></b>	V AC	690	690	690	690	690	690	690	690	690	
<b>Thermal rated current I<sub>th</sub></b> to bis 690V Ambient temperature	max. 40°C	A	10	10	25	10	10	16	26	10	10
	max. 60°C	A	6	6	20	6	-	-	-	-	6
<b>Frequency of operations z</b>	1/h	3000	-	3000	3000	-	-	-	1200	3000	
<b>Mechanical life</b>	S x 10 <sup>6</sup>	10	10	10	10	-	-	-	1	10	
<b>Power loss</b> per pole at I <sub>e</sub> /AC1	W	0,5	0,5	1,5	0,5	-	-	-	-	-	
<b>Utilization category AC15</b>											
Rated operational current I <sub>e</sub>	220-240V	A	3	3	6	3	3	3	-	4	3
	380-400V	A	2	2	3	2	2	2	-	3	2
	440V	A	1,6	1,6	2	1,6	1,5	1,5	-	2	1,6
	500V	A	1,2	1,2	2	1,2	1,5	1,5	-	2	1
	660-690V	A	0,6	0,6	1	0,6	1	1	-	2	0,5
<b>Utilization category DC13</b>											
Rated operational current I <sub>e</sub>	60V	A	2	2	8	2	-	-	-	2,5	2
	110V	A	0,4	0,4	1	0,4	0,5	0,5	-	1,5	0,4
	220V	A	0,1	0,1	0,1	0,1	0,2	0,2	-	0,2	0,1
<b>Short circuit protection</b> short-circuit current 1kA, contact welding not accepted max. fuse size gL (gG) A											
		20	20	25	20	10	10	-	10	10	
For contactors with thermal overload relay or auxiliary contacts the device with the smaller admissible control fuse (contactor or thermal overload relay) determines the fuse size.											
<b>Cable cross-sections</b>											
solid or stranded	mm <sup>2</sup>	0,75-2,5	0,75-2,5	0,75-2,5	0,75-2,5	0,75-2,5	0,75-2,5	0,75-2,5	1-2,5	0,75-2,5	
	flexible	mm <sup>2</sup>	0,75-2,5	0,75-2,5	0,75-2,5	0,75-2,5	0,75-2,5	0,75-2,5	0,75-2,5	0,75-2,5	
flexible with multicore cable end	mm <sup>2</sup>	0,5-1,5	0,5-1,5	0,5-1,5	0,5-1,5	0,5-1,5	0,5-1,5	0,5-1,5	0,75-2,5	0,5-1,5	
	solid	AWG	14 - 12	14 - 12	14 - 12	14 - 12	14 - 12	14 - 12	14 - 12	14 - 12	
	flexible	AWG	18 - 12	18 - 12	18 - 12	18 - 12	18 - 12	18 - 12	18 - 12	18 - 12	
Cables per clamp		2	2	2	2	2	2	2	2	2	

### Data according to CSA, UL and CUL

Type		HN	HTN	HA	HB..	HKA, HKT HKF	K2-DK K2-SK	K2-TP	K2-L <sup>2)</sup>
Rated operational current "General Use"	A	10	10	16	10	10	-	10	-
Rated operational voltage	max. V AC	600	600	600	600	600	-	600	600
<b>Auxiliary Contacts</b>		A600	A600	A600	A600	A600	-	A600	Intermittent duty

1) Suitable for: earthed-neutral systems, overvoltage category I to IV, pollution degree 3 (standard-industry): U<sub>imp</sub> = 8kV. Data for other conditions on request.

2) Command duration min. 30ms, 10% duty cycle, max. 30 sec.

# Contactors and Accessories

## Wiring diagrams

### Auxiliary contact blocks

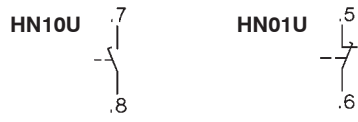
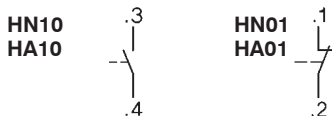

### Snap-on momentary contact blocks

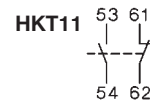
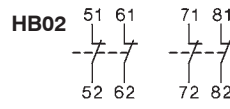
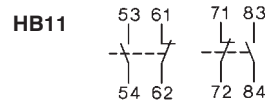
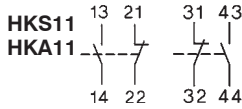
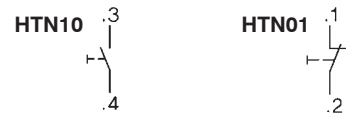

HB11, HB02:  
Correct terminal marking  
is given by mounting.

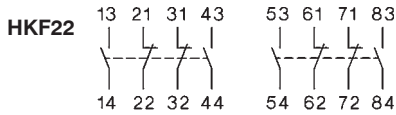

### Electronic timer

#### K3-T180 240

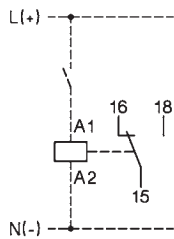

### Indicator units

#### Coil current indicator

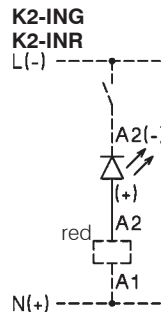

#### Voltage indicator

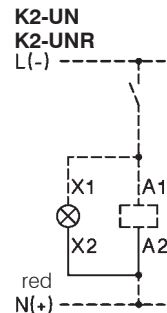

### Latch

#### K2-L..

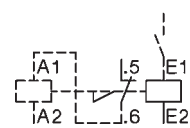

### Fuse holder

#### K2-F



with rectifier

#### K2-RF1 K2-RF3

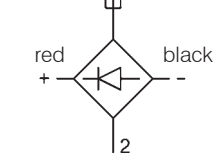

Colours mentioned in  
wiring diagram refer to  
the outgoing  
connection wires  
of the device.

### Interface

#### K2-IM

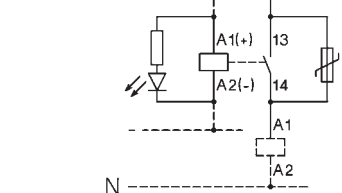

### Regulation of switch position of aux. contact block HKF22 for contactors K3-450 to K3-860

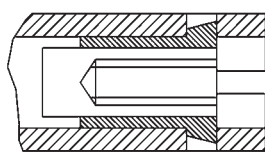
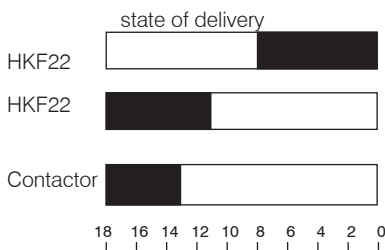

Standard position of regulation screw

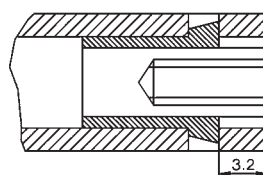
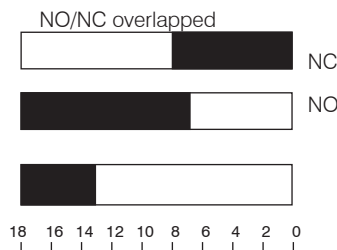

Regulation screw position (unscrew by 4 turns)

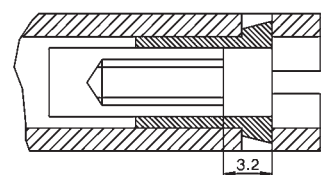
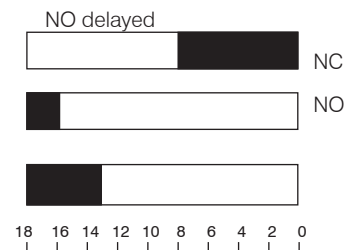

Regulation screw position (screw by 4 turns)



# Contactors

## Dimensions

### AC operated

K3-10N..  
K3-14N..  
K3-18N..  
K3-22N..

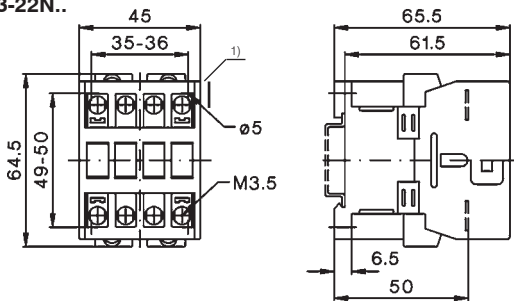

K3-24..  
K3-32..  
K3-40..

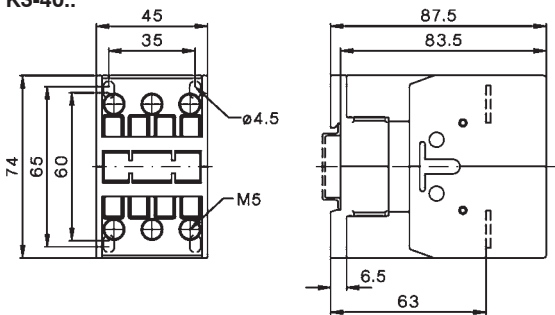

K3-50..  
K3-62..  
K3-74..

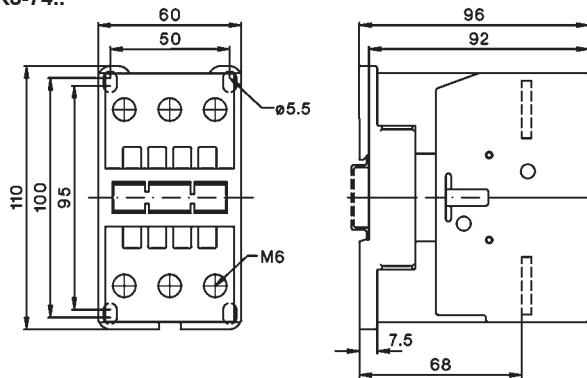

### AC and DC operated

K3-90..  
K3-115..

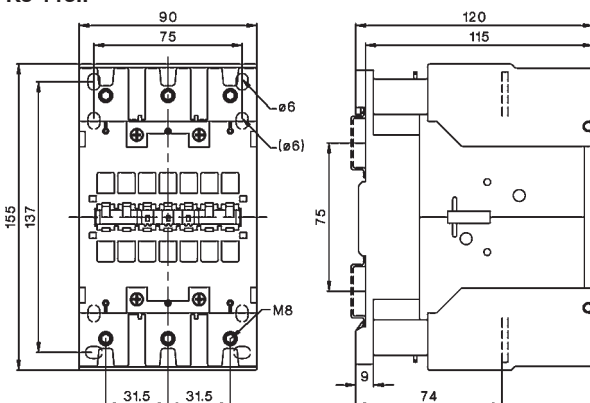

### DC operated

KG3-10..  
KG3-14..  
KG3-18..  
KG3-22..

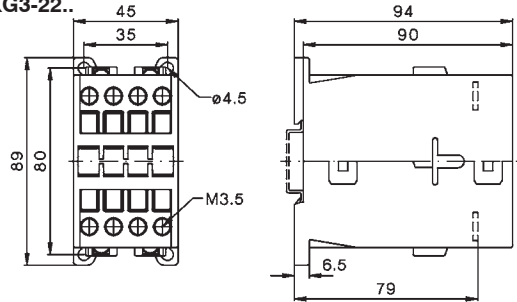

KG3-24..  
KG3-32..  
KG3-40..

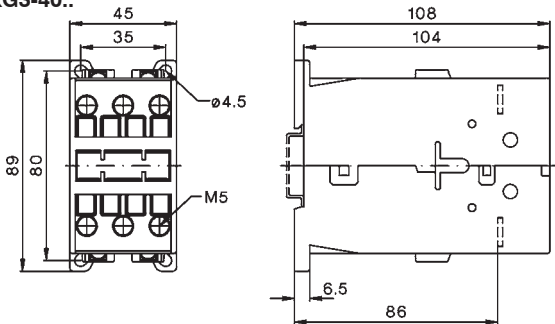

K3-50..=  
K3-62..=  
K3-74..=

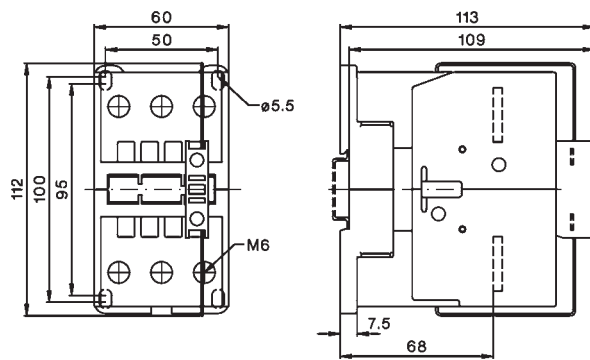

1) Minimum side distance to  
conductive parts for coil voltage:  
500V  $U_{imp}=6kV$  2mm  
660-690V  $U_{imp}=8kV$  4,5mm

# Contactors

Dimensions, AC operated, DC operated

K3-151..  
K3-176..

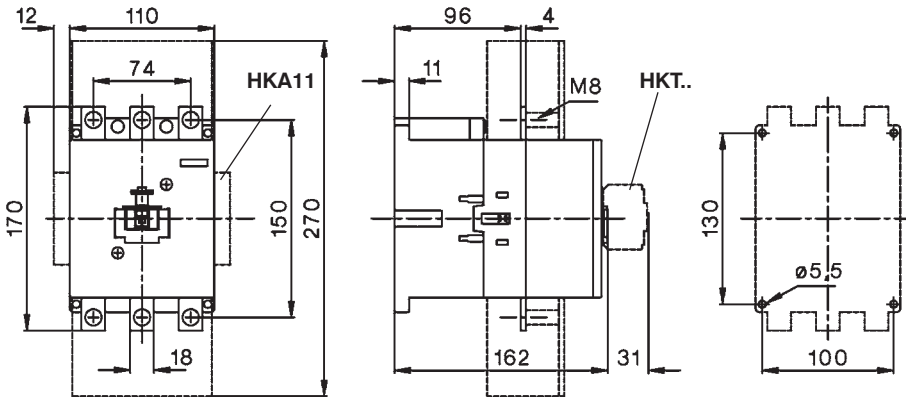

K3-210..  
K3-260..  
K3-316..

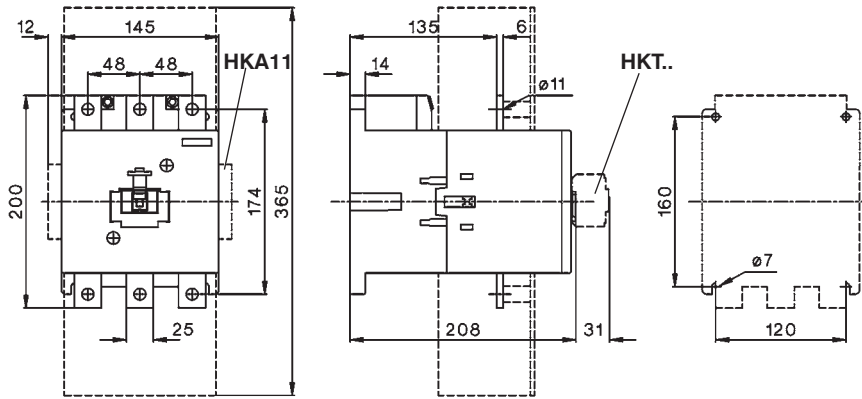

K3-450..  
K3-550..

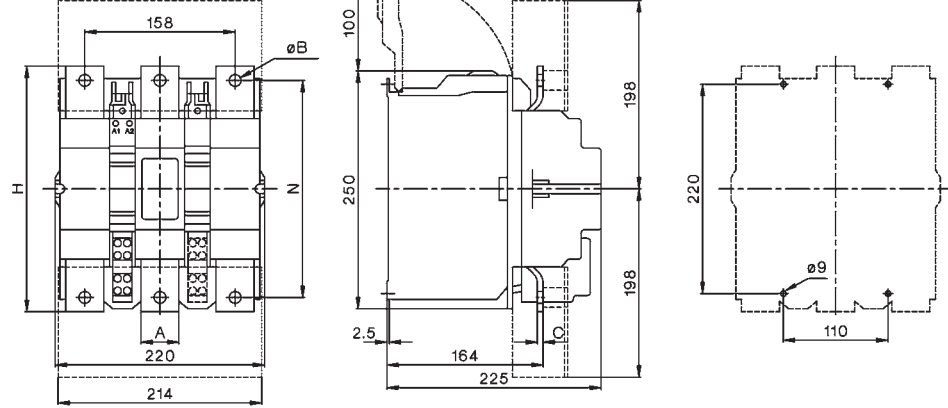

Type	A	B	C	H	N
K3-450	40	10,5	4	233	206
K3-550	40	12,5	6	258	228

K3-700..  
K3-860..

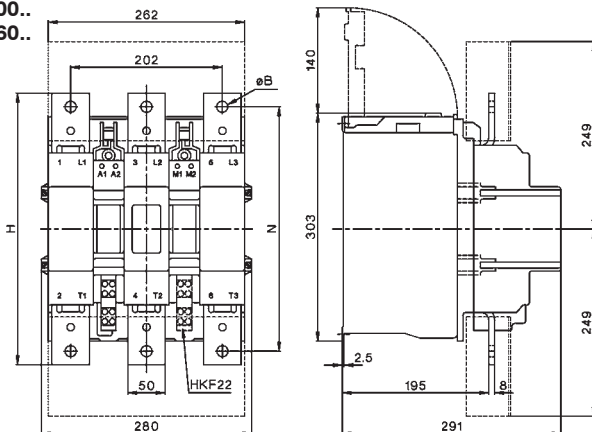

Type	B	H	N
K3-700	13	310	277
K3-860	15	361	325

# Contactors

## Dimensions

AC operated, DC operated

K3-1000..

K3-1200..

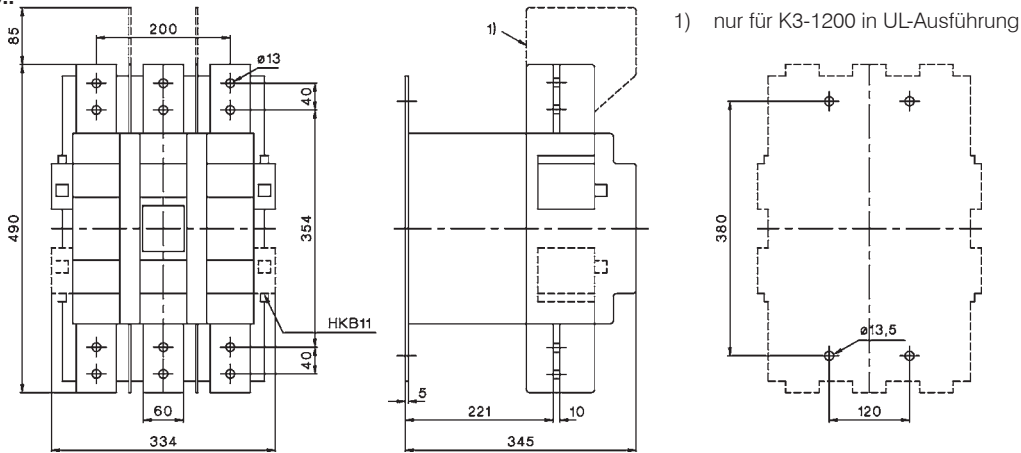

Capacitor Switching Contactors, AC operated

K3-18NK..

K3-18NBK..

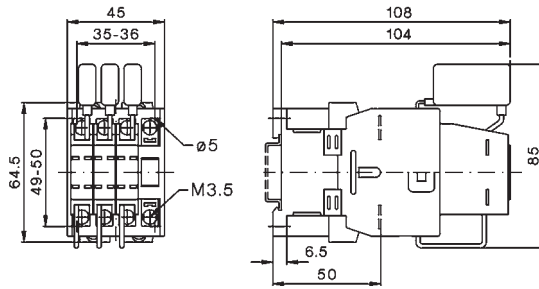
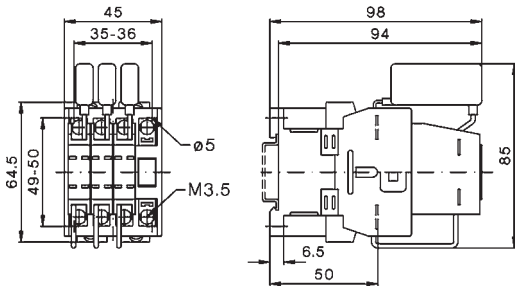

K3-24K..  
K3-32K..

K3-50K..  
K3-62K..  
K3-74K..

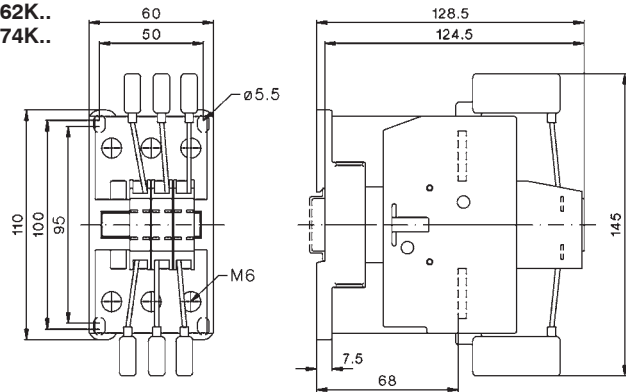
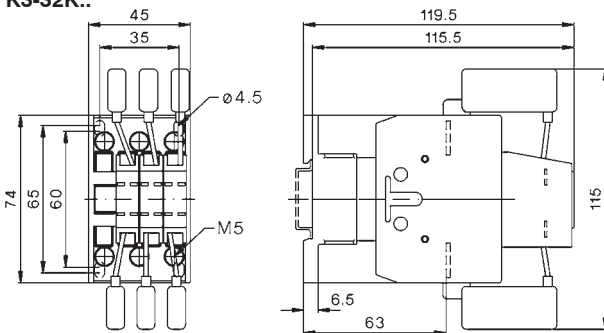

K3-90K..  
K3-115K..

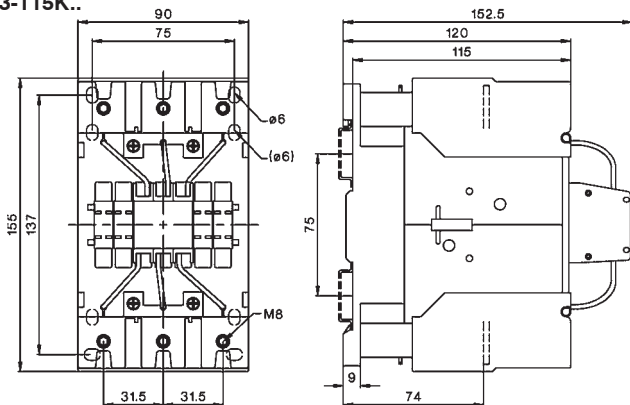

# Contactors

## Dimensions

### Contactors DC operated

- K3-10N..=
- K3-14N..=
- K3-18N..=
- K3-22N..=

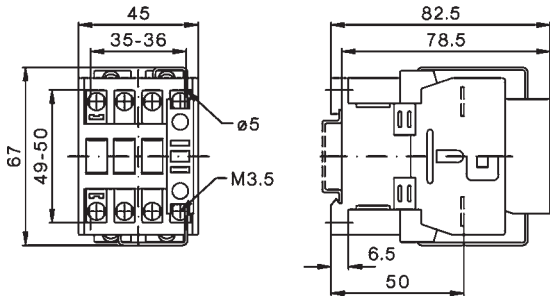

- K3-24..=
- K3-32..=
- K3-40..=

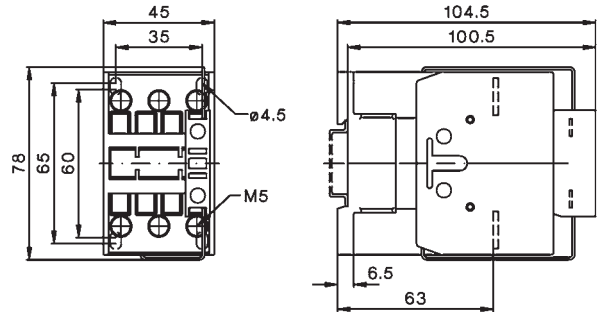

### Contactors 4-pole, AC operated / DC operated

- K3-10NA00-40
- K3-14NA00-40
- K3-18NA00-40
- K3-22NA00-40

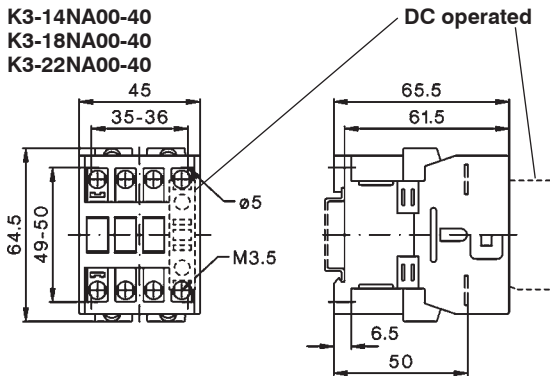

- K2-23A00-40
- K2-30A00-40
- K2-37A00-40

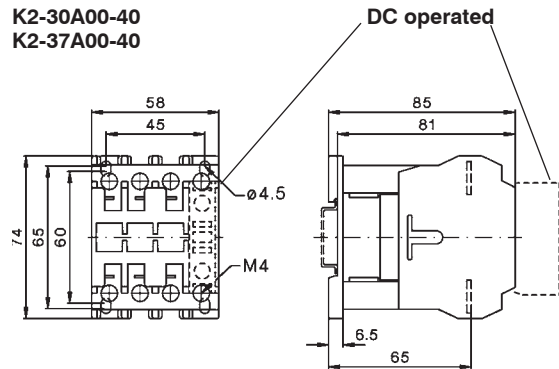

### Contactors 4-pole, AC operated / DC operated

- K2-45A00-40
- K2-60A00-40

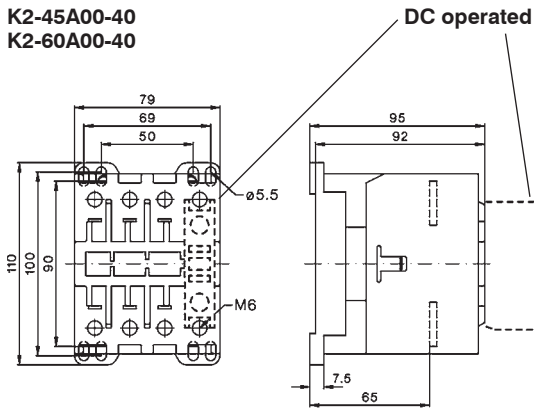

- K3-41A00-40

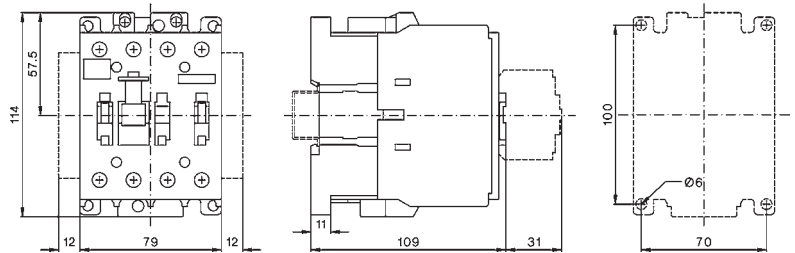

- K3-96A00-40

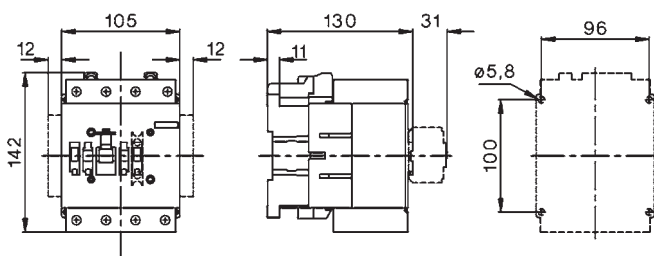

- K3-116A00-40
- K3-151A00-40
- K3-176A00-40

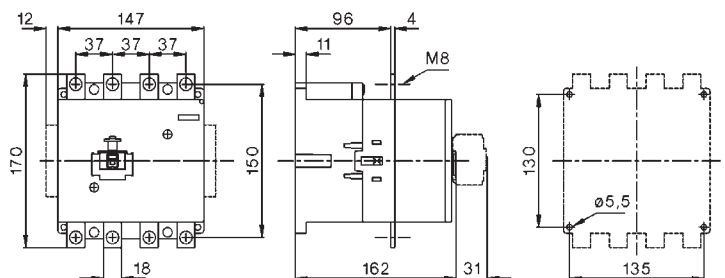

# Contactors

Contactors 4-pole, AC and DC operated

K3-210A00-40  
K3-260A00-40  
K3-316A00-40

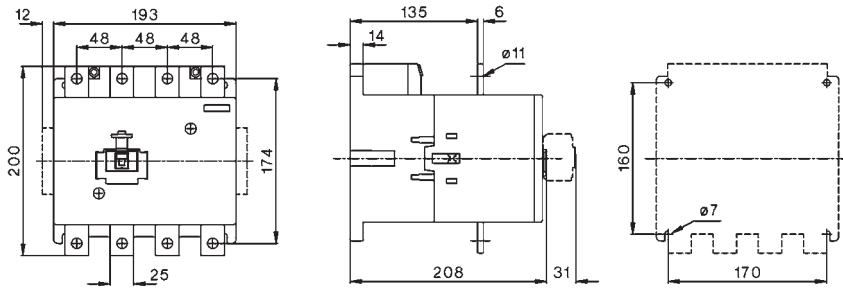

## Dimensions Accessories

Aux. cont. blocks, terminal blocks

Snap-on momentary cont. blocks

Auxiliary contact blocks

HN10, HN01

K2-SK, K2-DK

HTN10, HTN01

HA10, HA01

HB11, HB02

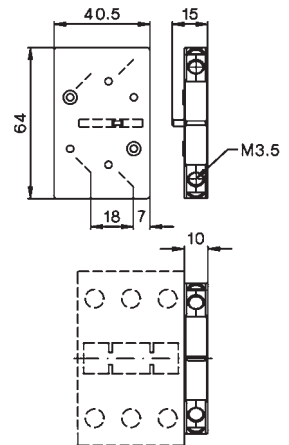
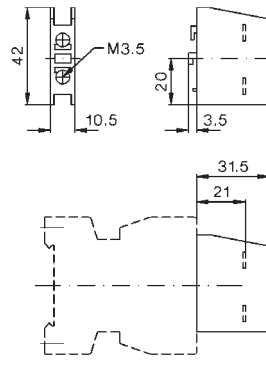
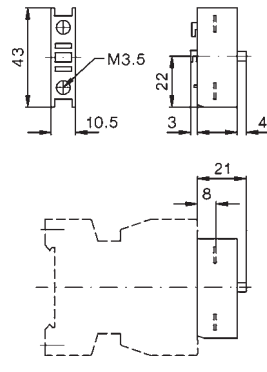
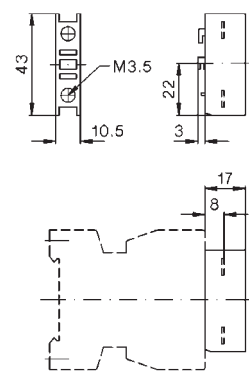

## 4. pole for contactors K3-200 to K3-1200

Type	A	B	C	D	E	F	G	H
NP175	223	148	26	52	98	5	122	M8
NP350	223	148	26	52	98	5	122	M8
NP325	262	148	26	55	116	5	122	M10
NP500	294	220	53	72	138	5	152	M12
NP760	294	220	53	72	138	5	152	M12
NP501	348	220	53	73	145	5	152	M12
NP1000	348	220	53	73	145	8	152	M12
NP1001	410	220	53	110	157	8	152	M12

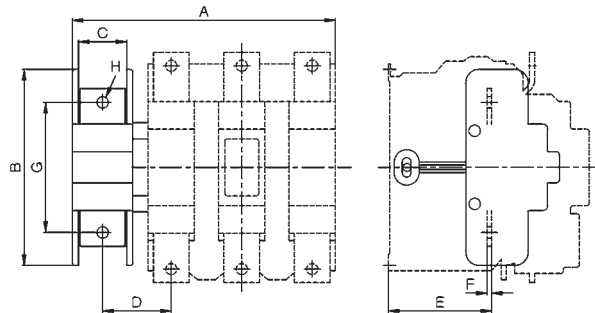

## Electronic timer

K3-T180 240

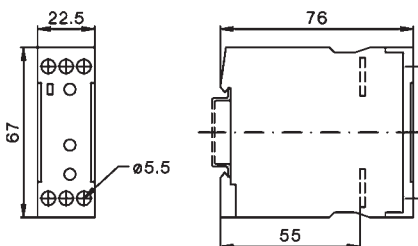

## Electronic timer on-delay

K2-TE..

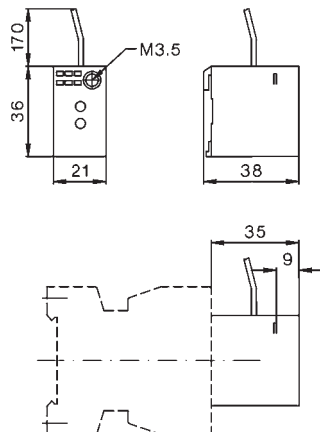

# Contactors

## Dimensions Accessories

### Mechanical interlocks

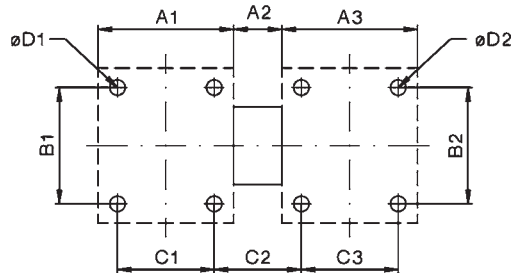

Type	Contactor 1	Contactor 2	A1	A2	A3	B1	B2	C1	C2	C3	D1	D2	
<b>LG10889</b>	K3-07 to K3-40	K3-07 to K3-40	45	7	45	50	50	35	17	35	4,5	4,5	
<b>LG10889</b>	KG3-07 to KG3-22	KG3-07 to KG3-22	45	7	45	80	50	35	17	35	4,5	4,5	
<b>LG10889</b>	KG3-24 to KG3-40	KG3-22 to KG3-40	45	7	45	80	50	35	17	35	4,5	4,5	
<b>LG10890</b>	K3-50 to K3-74	K3-24 to K3-40	60	12	55	100	65	50	22	45	5,5	4,5	
<b>LG10890</b>	K3-50 to K3-74	K3-50 to K3-74	60	12	60	100	100	50	22	50	5,5	5,5	
<b>LG11478</b>	K3-90 to K3-115	K3-90 to K3-115	90	12	90	100	100	75	27	75	5,5	5,5	
<b>LG8511</b>	K65 - K110	K65 - K110	90	12	90	100	100	75	27	75	6	6	
<b>LG11223H</b>	K3-151, -176	K3-151, -176	110	30	110	130	130	100	40	100	6	6	3-pole contactor
<b>LG11223H</b>	K3-116, -151, -176	K3-116, -151, -176	147	30	147	130	130	135	42	135	6	6	4-pole contactor
<b>LG11223H</b>	K3-210, -260, -316	K3-210, -260, -316	145	30	145	160	160	120	55	120	6	6	3-pole contactor
<b>LG11223H</b>	K3-210, -260, -316	K3-210, -260, -316	193	30	193	160	160	170	55	170	6	6	4-pole contactor
<b>LG10400H</b>	K3-450, K3-550	K3-450, K3-550	220	42	220	220	220	110	152	110	9	9	
<b>LG10402H</b>	K3-700, -860	K3-700, -860	280	32	280	280	280	175	137	175	11	11	
<b>LG10403H</b>	K3-1000, -1200	K3-1000, -1200	334	46	334	380	380	120	260	120	13,5	13,5	
<b>LG10399H</b>	K3-450, -550	K3-700, -860	220	37	280	220	280	110	144,5	175	9	11	
<b>LG10401H</b>	K3-700, -860	K3-1000, -1200	280	73	334	280	380	175	232,5	120	11	13,5	

**LG10400V, LG10402V**

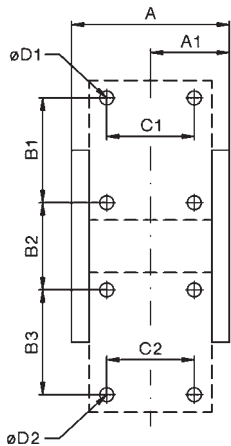

**LG10399V**

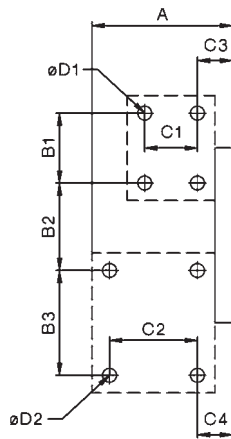

**LG10403V, LG10401V**

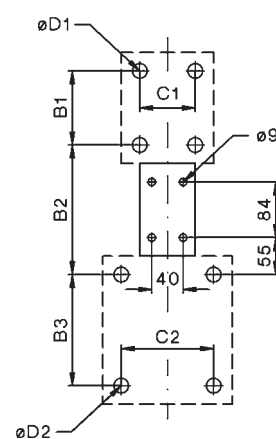

Type	Contactor 1	Contactor 2	A	A1	B1	B2	B3	C1	C2	C3	C4	D1	D2
<b>LG10400V</b>	K3-315 - K3-550	K3-315 - K3-550	250	134	220	94	220	110	110	-	-	9	9
<b>LG10402V</b>	K3-700, -860	K3-700, -860	302	162	280	200	280	175	175	-	-	11	11
<b>LG10403V</b>	K3-1000, -1200	K3-1000, -1200	-	-	380	280	380	120	120	-	-	13,5	13,5
<b>LG10399V</b>	K3-450, -550	K3-700, -860	302	-	220	150	280	110	175	51	74,5	9	11
<b>LG10401V</b>	K3-700, -860	K3-1000, -1200	-	-	280	240	380	175	120	-	-	11	13,5

# Contactors

## Dimensions Accessories

### Latch

#### K2-L..

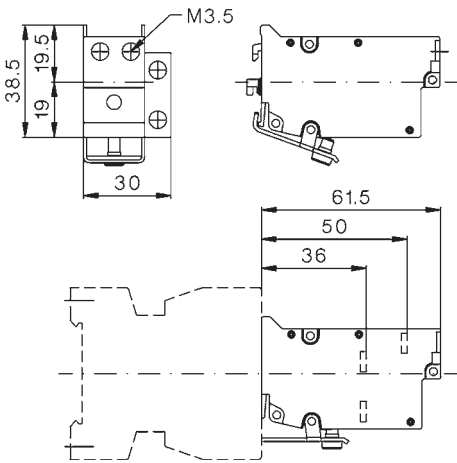

### Contactors with additional terminals

#### LG9339N (2 x 3 pieces) for K3-10N. to K3-22N.

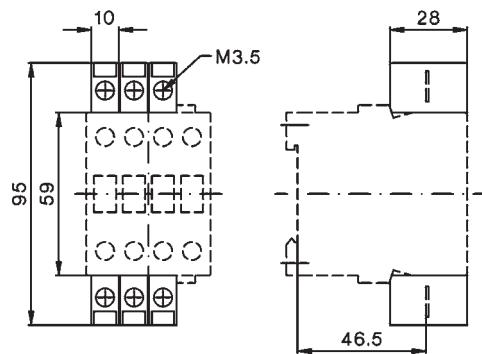

### Indicator units

#### K2-ING, K2-INR K2-UN, K2-UNR

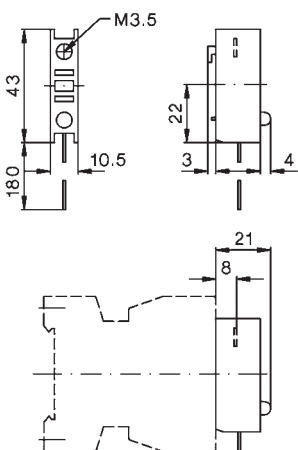

### Fuse holder

#### K2-RF

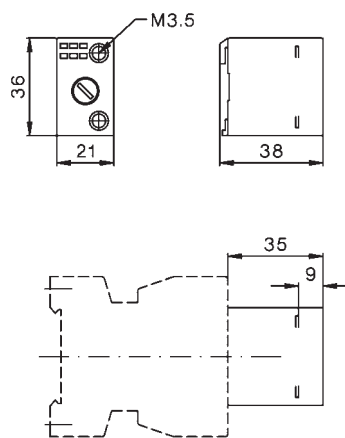

### Fuse holder with rectifier

#### K2-RF1 K2-RF3

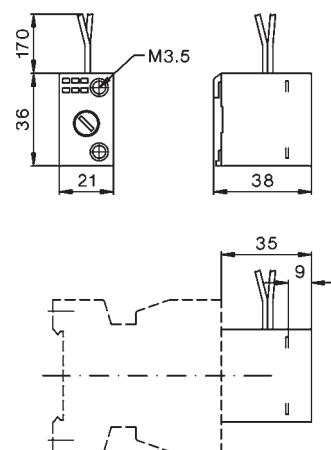

# Contactors

## Dimensions Accessories

### Interface

#### K2-IM

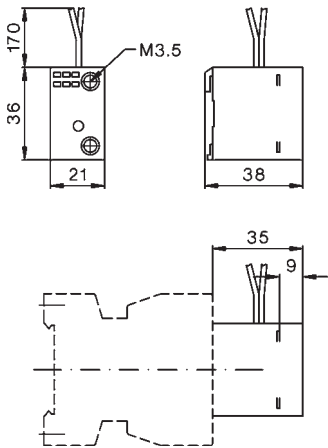

### Snap-on adapter

#### K2-SM

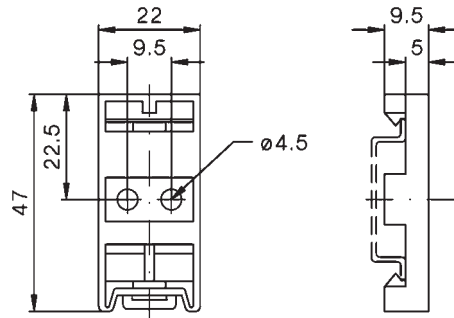

### Suppressor units

#### RC-K3N ..

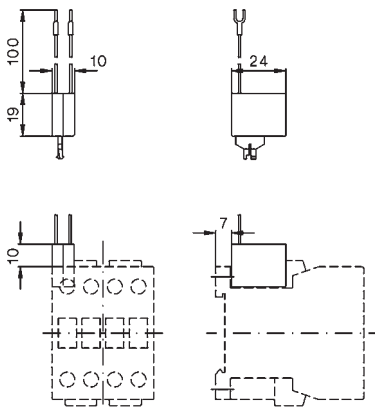

#### RC-K3NW ..

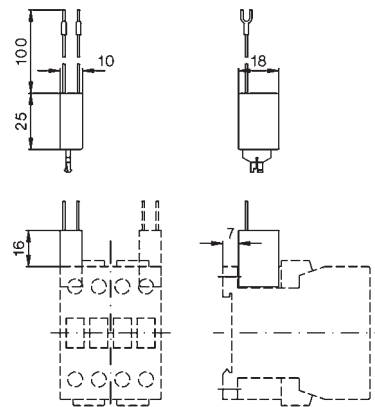

### Marking systems

marking label

**P487-1** or **P245-**

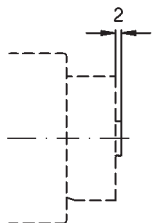



# Contactors

## Position of terminals

K3-10ND10  
K3-14ND10  
K3-18ND10  
K3-22ND10  
K3-18NK10

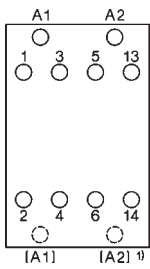

K3-10ND01  
K3-14ND01  
K3-18ND01  
K3-22ND01  
K3-18NK01

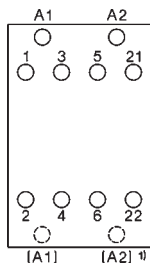

K3-24A00, K3-24K00  
K3-32A00, K3-32K00  
K3-40A00

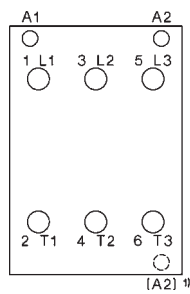

K3-50A00, K3-50K00  
K3-62A00, K3-62K00  
K3-74A00, K3-74K00

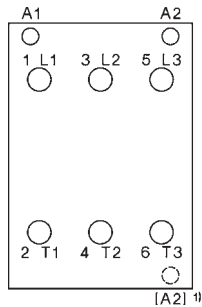

K3-10NA00-40  
K3-14NA00-40  
K3-18NA00-40  
K3-22NA00-40  
K2-23A00-40 to  
K2-60A00-40

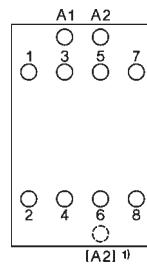

K85A22  
K110A22

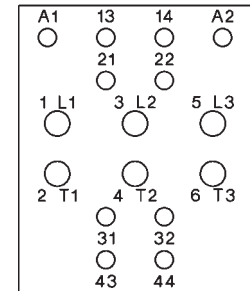

K3-90A00  
K3-115A00

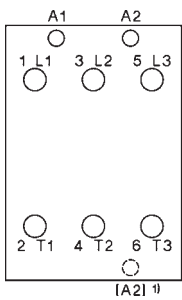

K3-151A00  
K3-176A00  
K3-210A00  
K3-260A00  
K3-316A00

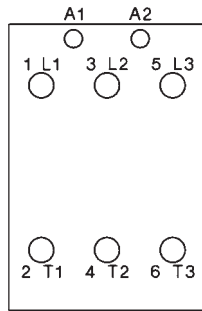

K3-116A00-40  
K3-151A00-40  
K3-176A00-40  
K3-210A00-40  
K3-260A00-40  
K3-316A00-40

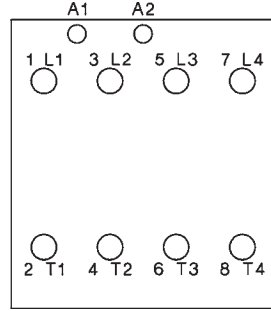

K3-450A22  
K3-550A22  
K3-700A22  
K3-860A22

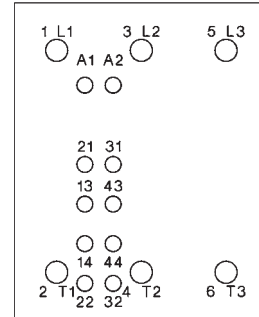

K3-1000A12  
K3-1200A12

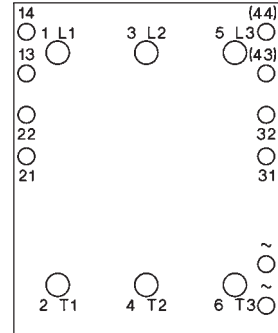

KG3-10A10  
KG3-14A10  
KG3-18A10  
KG3-22A10

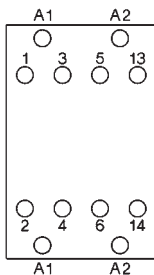

KG3-10A01  
KG3-14A01  
KG3-18A01  
KG3-22A01

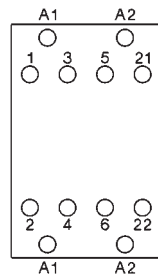

KG3-10A00-40  
KG3-14A00-40  
KG3-18A00-40  
KG3-22A00-40

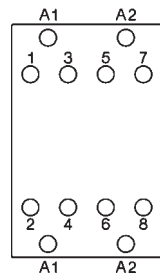

KG3-24A00  
KG3-32A00  
KG3-40A00

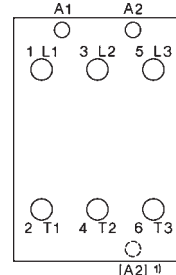

K3-10ND10=  
K3-14ND10=  
K3-18ND10=  
K3-22ND10=

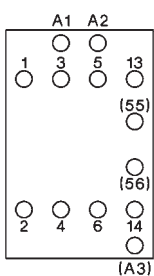

K3-10ND01=  
K3-14ND01=  
K3-18ND01=  
K3-22ND01=

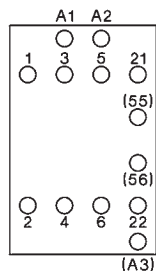

K3-24A00=  
K3-32A00=  
K3-40A00=

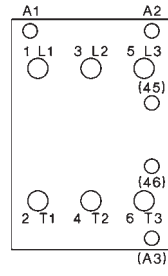

K3-50A00=  
K3-62A00=  
K3-74A00=

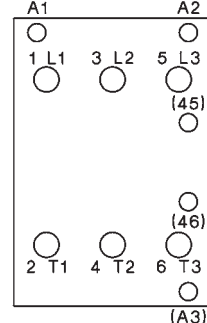

K85A21=  
K110A21=

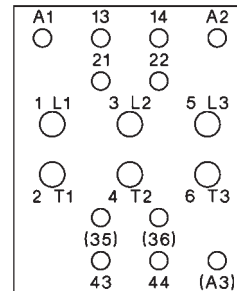

K3-1000A12=  
K3-1200A12=

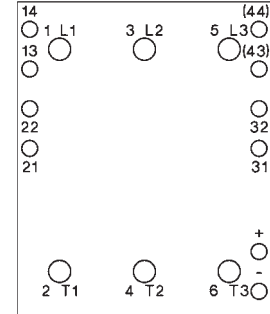

1) Type-suffix "EUR" with additional coil terminal  
Ordering example: K3-10ND10 EUR 230

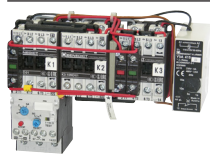

Star-Delta Starters Open Type

92



Star-Delta Starters Enclosed  
Enclosure for Star-Delta Starters

94

94

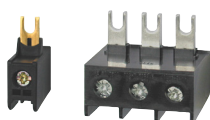

Accessories

95



Reversing Contactors

96



Pole Changing Starters

98



Technical Data

100

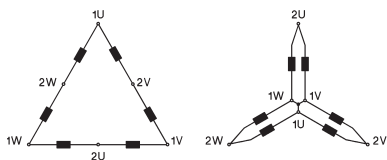

Wiring Diagrams

103

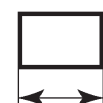

Dimensions

107

# Star-Delta Starters Open Type

AC Operated

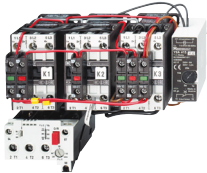

Ratings		Rated Current		order separately	Type	Coil voltage <sup>1)</sup>	Pack pcs.	Weight kg/pc.
AC3	380V	660V	AC3	Overload Relay	230	220-240V 50Hz		
400V	415V	500V	690V	400V	400	380-415V 50Hz		
kW	kW	kW	A	Type	↓			
7,5	7,5	11	16	U3/32 U12/16E K3	<b>K3NY15 ...</b>		1	0,9
15	18,5	15	30		<b>K3NY26 ...</b>		1	0,9
22	30	22	45	U3/42	<b>K3Y40 ...</b>		1	1,4
30	37	30	60		<b>K3Y52 ...</b>		1	1,8
45	55	45	85	U3/74	<b>K3Y80 ...</b>		1	3,5
55	75	55	109		<b>K3Y100 ...</b>		1	3,7
75	90	90	150	U85	<b>K3Y140 ...</b>		1	6,6
110	132	110	205		<b>K3Y200 ...</b>		1	7
132	160	160	240	U180	<b>K3Y240 ...</b>		1	15
160	180	180	300		<b>K3Y300 ...</b>		1	15

Star-delta starters are wired to accept thermal overload relay. The thermal overload relay has to be ordered separately. For full load current setting use the YD-dial of thermal overload relay.

**Ordering Example:** Star-Delta Starter, open type, rated AC3 at 400V 205A rated control voltage 230V 50Hz - **Order Type: K3Y200 230 + U85 120**

## Thermal Overload Relays

Rated Motor Current A	Type	Pack pcs.	Weight kg/pc.	Wiring Diagram
--------------------------	------	-----------	---------------	----------------

For Star-Delta Starters K3NY15.. to K3Y40..



7 - 10,5	<b>U12/16E 6 K3</b>	1	0,10	
10,5 - 15,5	<b>U12/16E 9 K3</b>	1	0,10	
14 - 19	<b>U12/16E 11 K3</b>	1	0,10	
18 - 24	<b>U12/16E 14 K3</b>	1	0,10	
23 - 31	<b>U12/16E 18 K3</b>	1	0,10	

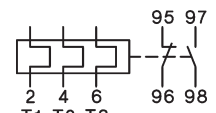

manual reset

For Star-Delta Starters K3NY15.. to K3Y52..



7 - 10,5	<b>U3/32 6</b>	1	0,14	
10,5 - 15,5	<b>U3/32 9</b>	1	0,14	
14 - 19	<b>U3/32 11</b>	1	0,14	
18 - 24	<b>U3/32 14</b>	1	0,14	
23 - 31	<b>U3/32 18</b>	1	0,14	
30 - 41	<b>U3/32 24</b>	1	0,14	
40 - 55	<b>U3/32 32</b>	1	0,14	

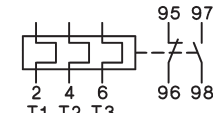

manual and auto reset

For Star-Delta Starters K3Y40.., K3Y52..



24 - 35	<b>U3/42 20</b>	1	0,30	
35 - 48	<b>U3/42 28</b>	1	0,30	
48 - 73	<b>U3/42 42</b>	1	0,30	

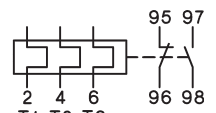

manual and auto reset

1) Coil voltage range and other coil voltages see page 100

Components for Combinations			Electronic Timer	Mechanical Interlock between K2 and K3	Star-Delta Starter Connector Type	Auxiliary Contacts Built-in for use on Contactor			Free Space for Aux. Contact Blocks on Contactor		
Line Contactor	Delta Contactor	Star Contactor				Line K1	Delta K2	Star K3	Line K1	Delta K2	Star K3
K3-10ND01 + HN10	K3-10ND01	K3-10ND10 + HN10 + HN01	Y9A	LG10889	K3NY-VB10	-	-	-	3	4	2
K3-18ND01 + HN10	K3-18ND01	K3-14ND10 + HN10 + HN01	Y9A	LG10889	K3NY-VB10	-	-	-	3	4	2
K3-24A00 + HN10 + HN01	K3-24A00 + HN01	K3-24A00 + 2HN10 + HN01	Y9A	LG10889	K3Y-VB24	-	-	-	2	3	1
K3-32A00 + HN10 + HN01	K3-32A00 + HN01	K3-24A00 + 2HN10 + HN01	Y9A	LG10889	K3Y-VB24	-	-	-	2	3	1
K3-50A00 + HN01 + HN10	K3-50A00 + HN01	K3-32A00 + 2HN10 + HN01	Y9A	LG10890	-	-	-	-	2	3	1
K3-62A00 + HN01 + HN10	K3-62A00 + HN01	K3-50A00 + 2HN10 + HN01	Y9A	LG10890	-	-	-	-	2	3	1
K3-90A00 + HN01 + HN10	K3-90A00 + HN01	K3-90A00 + 2HN10 + HN01	Y9AL	LG11478	-	-	-	-	5	6	4
K3-115A00 + HN01 + HN10	K3-115A00 + HN01	K3-90A00 + 2HN10 + HN01	Y9AL	LG11478	-	-	-	-	5	6	4
K3-151A00 + HKT11	K3-151A00 + HKT11	K3-151A00 + HKT22	Y9AL	LG11223H	-	-	1/-	-/1	2	1	1
K3-176A00 + HKT11	K3-176A00 + HKT11	K3-151A00 + HKT22	Y9AL	LG11223H	-	-	1/-	-/1	2	1	1

**Applications**

The star-delta starting method is only practicable in such cases where the motor windings are connected in delta configuration for normal operation and the torque which is needed during the starting period is not higher than approx. 30% of the rated torque. The starting current drawn from the line will be approx. 2 to 2,7 times the rated motor current.

**Time setting**

The transition from start (star configuration) to normal operation (delta configuration) should be after the motor achieves practically full rotational speed. The use of star-delta timer Y9A with a dwell period of approx. 25ms provides a careful operation of motor and drive equipment.

**Thermal Overload Relays**



**Rated Motor Current**  
A

**Type**

Pack pcs. Weight kg/pc.

Wiring Diagram

For Star-Delta Starters K3Y80.., K3Y100..

35 - 48	<b>U3/74 28</b>	1	0,40
48 - 73	<b>U3/74 42</b>	1	0,40
70 - 90	<b>U3/74 52</b>	1	0,40
90 - 112	<b>U3/74 65</b>	1	0,40

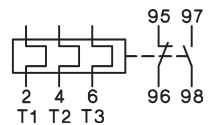

manual and auto reset

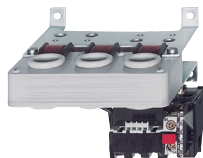

For Star-Delta Starters K3Y140.., K3Y200..

104 - 156	<b>U85 90</b>	1	0,90
140 - 207	<b>U85 120</b>	1	0,90

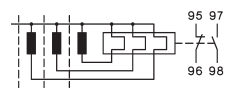

manual reset



For Star-Delta Starters K3Y240.., K3Y300..

208 - 312	<b>U180 180</b>	1	1,5
-----------	-----------------	---	-----

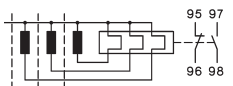

manual and auto reset

# Star-Delta Starters Enclosed Type

AC Operated

Ratings		Rated Current	Optional Extras	Wired to accept Overload Relay	Type	Coil voltage <sup>1)</sup>	Pack pcs.	Weight kg/pc.
AC3						220-240V 50Hz		
<b>380V</b>					<b>230</b>	380-415V 50Hz		
<b>400V</b>	660V	AC3			<b>400</b>			
<b>415V</b>	500V	690V	400V		↓			
<b>kW</b>	kW	kW	A	Type				



## Plastic Enclosed, protected to IP65

Rated Current (A)	Rated Power (kW)	Rated Voltage (V)	Rated Current (A)	Optional Extras	Wiring	Type	Pack pcs.	Weight kg/pc.
7,5	7,5	11	16	ST	U3/32	<b>K3NY15P ...</b>	1	1,8
15	18,5	15	30	ST		<b>K3NY26P ...</b>	1	1,8
22	30	22	45	ST, H	U3/42	<b>K3Y40P ...</b>	1	3,8
30	37	30	60	ST, H		<b>K3Y52P ...</b>	1	4,2
45	55	45	85	ST, H	U3/74	<b>K3Y80P ...</b>	1	5,9
55	75	55	109	ST, H		<b>K3Y100P ...</b>	1	8,7



## Sheet Steel Enclosed, protected to IP54

Rated Current (A)	Rated Power (kW)	Rated Voltage (V)	Rated Current (A)	Optional Extras	Wiring	Type	Pack pcs.	Weight kg/pc.
7,5	7,5	11	16	ST,H	U3/32	<b>K3NY15B ...</b>	1	2,8
15	18,5	15	30	ST, H		<b>K3NY26B ...</b>	1	2,8
22	30	22	45	ST, H	U3/42	<b>K3Y40B ...</b>	1	4,8
30	37	30	60	ST, H		<b>K3Y52B ...</b>	1	5,2
45	55	45	85	ST, H	U3/74	<b>K3Y80B ...</b>	1	15
55	75	55	109	ST, H		<b>K3Y100B ...</b>	1	15
75	90	90	150	ST, H	U85	<b>K3Y140B ...</b>	1	22
110	132	110	205	ST, H		<b>K3Y200B ...</b>	1	22

1) Coil voltage range and other coil voltages see page 100

### Type-suffix for optional extras

Start-Stop Push Buttons	.....T ...
Selector Switch	.....W ...
Control Circuit Fuse <250V (1 piece)	.....ST ...
>250V (2 pieces)	.....ST ...
Run Hour Meter	.....H ...

**Ordering Example:** Star-Delta Starter, steel sheet enclosed, with selector switch and run hour meter rated AC3 at 400V 82A, rated control voltage 230V 50Hz - **Order Type: K3Y80BWH 230 + U3/74 52**

## Enclosures for Star Delta Starter



for Starter	accept Overload Relay	Type	Pack pcs.	Weight kg/pc.
<b>Plastic IP65</b>				
<b>K3NY15, K3NY26</b>	U3/32	<b>K3Y26P-G3</b>	1	1,0
<b>K3Y40, K3Y52</b>	U3/42, U3/32	<b>K3Y40/52P-G3</b>	1	2,4
<b>Sheet Steel IP54</b>				
<b>K3NY15, K3NY26</b>	U3/32	<b>K3Y26B-G3</b>	1	3,4
<b>K3Y40, K3Y52</b>	U3/42, U3/32	<b>K3Y40/52B-G3</b>	1	3,4

## Star-Delta Starter Connector



For Star-Delta Starter Types

	Type	Pack pcs.	Weight kg/pc.
K3NY15, K3NY26	<b>K3NY-VB10</b>	1	0,02
K3Y40, K3Y52	<b>K3Y-VB24</b>	1	0,03

## Additional Terminals



For Star-Delta Starter Types  
Line Conn. Motor Conn.  
Line Contactor Overload Relay

Cable cross-section mm<sup>2</sup>

Type

Pack pcs. Weight kg/pc.

### Single pole with Fingertouch Protection

K3NY15, K3NY26	U12/16	0,75 - 10 solid 0,75 - 6 flex.	<b>LG9339</b>	6	0,009
----------------	--------	-----------------------------------	---------------	---	-------

### Three-pole with Fingertouch Protection

	U3/42	4 - 35 strand. 4 - 25 flex.	<b>LG7559</b>	1	0,052
--	-------	--------------------------------	---------------	---	-------

## Electronic Timers for Star-Delta Starters<sup>1)</sup>



Rated Control Voltage V	Time Range s	Delay Time ms	Rated Current AC15		Type	Pack pcs.	Weight kg/pc.
			230V A	400V A			
24 - 60V AC	1 - 20	20 - 25	6	4	<b>Y9A 60</b>	1	0,075
110 - 415V AC	1 - 20	20 - 25	6	4	<b>Y9A 415</b>	1	0,075
24 - 60V~	1 - 20	40 - 80	6	4	<b>Y9AL 60</b>	1	0,075
110 - 415V~	1 - 20	40 - 80	6	4	<b>Y9AL 415</b>	1	0,075

Time repeat accuracy	± 1%	Power consumption at	24V	0,2VA
Minimum interval between operations	2s		60V	5VA
Short circuit protection	4A gl (gG)		220-240V	2VA
			380-415V	7VA

1) not suitable for contactors K3-450 - K3-1200

## Mounting Bar

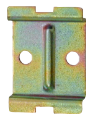

Specification	Type	Pack pcs.	Weight kg/pc.
For screw mounting of electronic timer Y9..	<b>LG7735</b>	10	0,09

## Star-Delta Starters in Special Versions

### Starters for Longer Starting Time

For longer starting times the thermal overload relay is mounted on delta-contactor. The motor is not protected in Y-connection. The timer used for this starter-type is the type Y91A, time range is 10 to 60s. Principal wiring diagram see page 104.

**Ordering Example:** K3YL52 230

### Starters with two Thermal Overload Relays on request

Basic circuit diagram see page 104

## Reversing Contactors with Mechanical Interlock

AC Operated

Ratings		Rated Current	Vorbereitet für Einbau	Wired to accept Overload Relay page 120 Type	Type	Coil voltage <sup>1)</sup>	Pack pcs.	Weight kg/pc.
AC3						110V 50Hz		
<b>380V</b>						220-240V 50Hz		
<b>400V</b>		660V	AC3			380-415 50Hz		
<b>415V</b>	500V	690V	400V					
<b>kW</b>	kW	kW	A					

### Open Type

<b>4</b>	5,5	5,5	10	U3/32 U12/16E K3	<b>K3NWU10 ...</b>	1	0,6
<b>7,5</b>	10	7,5	18		<b>K3NWU18 ...</b>	1	0,6
<b>11</b>	15	15	24	U3/42	<b>K3WU24 ...</b>	1	1,2
<b>15</b>	18,5	18,5	32		<b>K3WU32 ...</b>	1	1,4
<b>18,5</b>	18,5	18,5	40		<b>K3WU40</b>	1	1,4
<b>22</b>	30	30	50	U3/74	<b>K3WU50 ...</b>	1	2,5
<b>30</b>	37	37	62		<b>K3WU62 ...</b>	1	2,5
<b>37</b>	45	45	74		<b>K3WU74 ...</b>	1	2,5



### Sheet Steel Enclosed, protected to IP54

<b>4</b>	5,5	5,5	10	U3/32	<b>K3NWU10B ...</b>	1	3,9
<b>7,5</b>	10	7,5	18		<b>K3NWU18B ...</b>	1	4,1
<b>11</b>	15	15	24	U3/42	<b>K3WU24B ...</b>	1	4,5
<b>15</b>	18,5	18,5	32		<b>K3WU32B ...</b>	1	4,7
<b>22</b>	30	30	50	U3/74	<b>K3WU50B ...</b>	1	7,1
<b>30</b>	37	37	62		<b>K3WU62B ...</b>	1	7,1



## Reversing Starter Connector



For Reversing Starter Types

	Type	Pack pcs.	Weight kg/pc.
K3NWU10, K3NWU18	<b>K3NW-VB10</b>	1	0,02
K3WU24, K3WU32	<b>K3W-VB24</b>	1	0,025

1) Other coil voltages see page 57

Components for Combinations		Mechanical Interlock	Reversing Starter Connector	Auxiliary Contacts Built-in for use on Contactor		Free Space for Aux. Contact Blocks on Contactor	
Left Hand Side Contactor	Right Hand Side Contactor			K1 NO/NC	K2 NO/NC	K1 HN.. or HA..	K2
K1 Type	K2 Type	Type	Type				
K3-10ND10 + HN01	K3-10ND10 + HN01	LG10889	K3NW-VB10	-	-	3	3
K3-18ND10 + HN01	K3-18ND10 + HN01	LG10889	K3NW-VB10	-	-	3	3
K3-24A00 + HN10 + HN01	K3-24A00 + HN10 + HN01	LG10889	K3W-VB24	-	-	2	2
K3-32A00 + HN10 + HN01	K3-32A00 + HN10 + HN01	LG10889	K3W-VB24	-	-	2	2
K3-40A00 + HN10 + HN01	K3-40A00 + HN10 + HN01	LG10889	K3W-VB24	-	-	2	2
K3-50A00 + HN10 + HN01	K3-50A00 + HN10 + HN01	LG10890	-	-	-	2	2
K3-62A00 + HN10 + HN01	K3-62A00 + HN10 + HN01	LG10890	-	-	-	2	2
K3-74A00 + HN10 + HN01	K3-74A00 + HN10 + HN01	LG10890	-	-	-	2	2
K3-10ND10 + HN01	K3-10ND10 + HN01	LG10889	K3NW-VB10	-	-	3	3
K3-18ND10 + HN01	K3-18ND10 + HN01	LG10889	K3NW-VB10	-	-	3	3
K3-24A00 + HN10 + HN01	K3-24A00 + HN10 + HN01	LG10889	K3W-VB24	-	-	2	2
K3-32A00 + HN10 + HN01	K3-32A00 + HN10 + HN01	LG10889	K3W-VB24	-	-	2	2
K3-50A00 + HN10 + HN01	K3-50A00 + HN10 + HN01	LG10890	-	-	-	2	2
K3-62A00 + HN10 + HN01	K3-62A00 + HN10 + HN01	LG10890	-	-	-	2	2

Contactors, Motor-Starter

Circuit Breakers

Manual Motor-Starters

Switches

AC-Main Switches

DC-Switch Disconnect

Push Buttons

Representatives, Suppliers



## Pole Changing Starters

AC Operated

Ratings		Rated Current		Wired to accept Overload Relay page 120 Type	Type	Coil voltage <sup>1)</sup> 220-240V 50Hz 380-415 50Hz	Pack pcs.	Weight kg/pc.
AC3	380V	660V	AC3					
400V			400V		230 400 ↓			
415V	500V	690V	400V					
kW	kW	kW	A					

### Open Type



7,5	10	10	18	2 x U3/32 2 x U12/16E K3	K3NPU18 ...	1	1,0
11	15	15	24		K3NPU24 ...	1	1,5
15	18,5	18,5	32	2 x U3/32	K3PU32 ...	1	1,9
22	30	30	50	2 x U3/74	K3PU50 ...	1	3,9
30	37	37	62		K3PU62 ...	1	3,9

### Sheet Steel Enclosed, protected to IP54



7,5	10	7,5	18	2x U3/32	K3NPU18B ...	1	1,0
11	15	15	24		K3NPU24B ...	1	1,5
15	18,5	18,5	32		K3PU32B ...	1	1,9

**Ordering Example:** Pole Changing Starter, open version, rated AC3 at 400V 28A and 15A, control voltage 230V 50Hz  
**Order Type:** K3PU32 230 + U3/32 32 + U3/32 18

Pole Changing Starters for Star-Delta Operation on request

1) Other coil voltages see page 57

Components for Combinations		Star Contactor	Free Space for Aux. Contact Blocks on Contactor		
High Speed	Low Speed		High Speed K1 HN.. or HA..	Low Speed K2	Star K3
K1 Type	K2 Type	K3 Type			
K3-18ND01 + 2 x HN10	K3-18ND01 + HN10	K3-14ND10	2	3	4
K3-24A00 + HN01 + 2 x HN10	K3-24A00 + HN01 + HN10	K3-18ND10	1	2	4
K3-32A00 + HN01 + 2 x HN10	K3-32A00 + HN01 + HN10	K3-24A00 + HN10	1	2	3
K3-50A00 + HN01 + 2 x HN10	K3-50A00 + HN01 + HN10	K3-32A00 + HN10	1	2	3
K3-62A00 + HN01 + 2 x HN10	K3-62A00 + HN01 + HN10	K3-50A00 + HN10	1	2	3
K3-18ND01 + 2 x HN10	K3-18ND01 + HN10	K3-14ND10	2	3	4
K3-24A00 + HN01 + 2 x HN10	K3-24A00 + HN01 + HN10	K3-18ND10	1	2	4
K3-32A00 + HN01 + 2 x HN10	K3-32A00 + HN01 + HN10	K3-24A00 + HN10	1	2	3

# Star-Delta Starters

## Data according to IEC 947-4-1, VDE 0660, EN 60947-4-1

Type		K3NY15	K3NY26	K3Y40	K3Y52	K3Y80	K3Y100	K3Y140	K3Y200	K3Y240	K3Y300	
<b>Main Contacts</b>												
Rated insulation voltage $U_i^{(1)}$	V AC	690	690	690	690	690	690	690	690	690	690	
Frequency of operations $z_{AC3, I_e}$	1/h	15										
Change-over time max. (Y-step)	s	20 (Type K3YL ... 60)										
<b>Utilization category AC3</b>												
<b>Switching of three-phase motors</b>												
Rated operational current $I_e$	220-230V	A	16	30	45	60	85	109	150	205	240	300
	240V	A	16	30	45	60	85	109	150	205	240	300
	<b>380-400V</b>	<b>A</b>	<b>16</b>	<b>30</b>	<b>45</b>	<b>60</b>	<b>85</b>	<b>109</b>	<b>150</b>	<b>205</b>	240	300
Rated operational power of three-phase motors 50-60Hz	415-440V	A	15	30	45	60	85	109	150	205	240	300
	500V	A	15	30	45	60	85	95	150	205	190	240
	660-690V	A	13	17	30	36	57	72	103	118	147	180
Rated operational power of three-phase motors 50-60Hz	220-230V	kW	4	7,5	11	15	22	30	45	55	75	90
	240V	kW	5,5	11	15	18,5	22	30	45	55	75	90
	<b>380-400V</b>	<b>kW</b>	<b>7,5</b>	<b>15</b>	<b>22</b>	<b>30</b>	<b>45</b>	<b>55</b>	<b>75</b>	<b>110</b>	<b>132</b>	<b>160</b>
Rated operational power of three-phase motors 50-60Hz	415-440V	kW	7,5	15	22	30	45	55	75	110	140	170
	500V	kW	7,5	18,5	30	37	55	75	90	132	132	180
	660-690V	kW	11	15	22	30	45	55	90	110	132	180
<b>Cable cross-sections</b>												
Line	solid or stranded	mm <sup>2</sup>	1,5 - 6 <sup>2)</sup>		1,5 - 16		10 - 70 <sup>3)</sup>		10 - 120		busbar	
	flexible	mm <sup>2</sup>	1,5 - 4 <sup>2)</sup>		1,5 - 16		16 - 50 <sup>3)</sup>		10 - 95		18x5	
	flexible with multicore cable end	mm <sup>2</sup>	1,5 - 4 <sup>2)</sup>		1,5 - 16		10 - 35		10 - 95		M8	
Motor	solid or stranded	mm <sup>2</sup>	1,5 - 6		1,5 - 16		4 - 35 <sup>3)</sup>		10 - 120		busbar	
	flexible	mm <sup>2</sup>	1,5 - 4		1,5 - 16		6 - 25 <sup>3)</sup>		10 - 95		18x5	
	flexible with multicore cable end	mm <sup>2</sup>	1,5 - 4		1,5 - 16		4 - 25		10 - 95		M8	
<b>Power consumption of the combination</b>												
inrush and change-over	VA		55		130		183		560		700	
	sealed VA		20		26		36		10		10	
	W		6		8		14		10		10	

## Coil Voltage Ranges and Non Standard Voltages for Star-Delta Starters

### K3NY15.. to K3Y100..

Suffix to Star-Delta Starter type e.g. K3Y80 <b>400</b>	Rated Control Voltage $U_s$			
	range for 50Hz		range for 60Hz	
	min. V	max. V	min. V	max. V
24	24	24	24	27
42	42	47	47	52
110	100	110	110	122
180	180	210	200	240
<b>230</b>	<b>220</b>	<b>240</b>	<b>230</b>	<b>264</b>
<b>400</b>	<b>380</b>	<b>415</b>	<b>400</b>	<b>415</b>

### K3Y140, to K3Y300..

Suffix to Star-Delta Starter type e.g. K3Y300 <b>230</b>	Rated Control Voltage $U_s$				
	range for 50Hz		range for 60Hz		for DC
	min. V	max. V	min. V	max. V	V
24	24	24	24	24	24
48	48	48	48	48	48
110	110	120	110	120	110
<b>230</b>	<b>220</b>	<b>240</b>	<b>220</b>	<b>240</b>	<b>220</b>
<b>400</b>	<b>380</b>	<b>415</b>	<b>380</b>	<b>415</b>	-

### Standard voltages in bold type letters

1) Suitable for: earthed-neutral systems, overvoltage category I to IV, pollution degree 3 (standard-industry):  $U_{imp} = 8kV$ .  
Data for other conditions on request.

2) Additional terminals see page 95

3) Maximum cable cross-section with prepared conductor

# Reversing Starters

Data according to IEC 947-4-1, VDE 0660, EN 60947-4-1

Type		K3NWU10	K3NWU18	K3WU24	K3WU32	K3WU50	K3WU62	K3WU74
<b>Main Contacts</b>								
Rated insulation voltage $U_i^{(1)}$	V AC	690	690	690	690	690	690	690
<b>Utilization category AC3</b>								
<b>Switching of three-phase motors</b>								
Rated operational current $I_e$	220V A	12	18	23	30	45	63	
	230V A	11,5	18	24	32	50	62	74
	240V A	11	18	24	32	50	62	74
	<b>380-400V A</b>	<b>10</b>	<b>18</b>	<b>24</b>	<b>32</b>	<b>50</b>	<b>62</b>	<b>74</b>
	415-440V A	9	18	23	30	50	62	74
	500V A	9	16	23	30	45	60	74
	660-690V A	6,5	8,5	17	20	31	40	40
Rated operational power of three-phase motors 50-60Hz	220-230V kW	3	5	6	8,5	12,5	18,5	
	240V kW	3	5	7	9	13,5	19	23
	<b>380-400V kW</b>	<b>4</b>	<b>7,5</b>	<b>11</b>	<b>15</b>	<b>22</b>	<b>30</b>	<b>37</b>
	415-440V kW	4,5	8,5	12	16	24	33	40
	500V kW	5,5	10	15	18,5	30	37	45
	660-690V kW	5,5	10	15	18,5	30	37	45
<b>Cable cross-sections</b>								
Line	solid or stranded	mm <sup>2</sup>	0,75 - 6		1,5 - 25		4 - 50	
	flexible	mm <sup>2</sup>	1 - 4		2,5 - 16		6 - 35	
	flexible with multicore cable end	mm <sup>2</sup>	0,75 - 4		1,5 - 16		6 - 35	
Cables per clamp			1		1		1	
<b>Power consumption of the combination</b>								
inrush and change-over	VA	33 - 45		90 - 115		140 - 185		
	sealed VA	7 - 10		9 - 13		13 - 18		
	W	2,6 - 3		2,7 - 4		5,4 - 7		

## Technical Data according to UL508

Main Contacts (cULus)	Type	KNW3-10	KNW3-18	KW3-24	KW3-32	KW3-40
Rated operational power of three-phase motors at 60Hz (3ph)	110-120V hp	1½	2	5	5	7½
	200V hp	3	5	7½	10	10
	220-240V hp	3	7½	10	10	15
	277V hp	3	7½	7½	10	15
	380-415V hp	5	10	10	15	20
	440-480V hp	5	10	15	20	25
	550-600V hp	7½	15	20	25	30
Fuse / Short-circuit current	A/kA	30/5	50/5	90/5	125/5	175/5
Rated voltage	V	600	600	600	600	600
<b>Auxiliary Contacts (cULus)</b>		A600	A600	A600	A600	A600
<b>Cable cross-sections</b>						
for main connectors	solid	AWG	18 - 10		16 - 10	
	flexible	AWG	18 - 10		14 - 4	
Cables per clamp			1		1	

1) Suitable for: earthed-neutral systems, overvoltage category I to IV, pollution degree 3 (standard-industry):  $U_{mp} = 8kV$ . Data for other conditions on request.

## Pole Changing Starters

Data according to IEC 947-4-1, VDE 0660, EN 60947-4-1

Type		K3NPU18	K3NPU24	K3PU32	K3PU50	K3PU62
<b>Main Contacts</b>						
Rated insulation voltage $U_i$ <sup>1)</sup>	V AC	690	690	690	690	690
<b>Utilization category AC3</b>						
<b>Switching of three-phase motors</b>						
Rated operational current $I_e$	220V A	18	23	30	45	63
	230V A	17,5	23	30	45	60
	240V A	17	23	30	45	60
	<b>380-400V A</b>	<b>16</b>	<b>23</b>	<b>30</b>	<b>45</b>	<b>60</b>
	415V A	16	23	30	45	60
	440V A	16	23	30	45	60
	500V A	16	23	30	45	55
	660V A	9	17,5	21	33	42
	690V A	8,5	17	20	31	40
Rated operational power of three-phase motors 50-60Hz	220-230V kW	5	6	8,5	12,5	18,5
	240V kW	5	7	9	13,5	19
	<b>380-400V kW</b>	<b>7,5</b>	<b>11</b>	<b>15</b>	<b>22</b>	<b>30</b>
	415-440V kW	8,5	12	16	24	33
	500V kW	10	15	18,5	30	37
	660-690V kW	7,5	15	18,5	30	37
<b>Cable cross-sections</b>						
Line	solid or stranded mm <sup>2</sup>	0,75 - 6	1,5 - 25		4 - 50	
	flexible mm <sup>2</sup>	1 - 4	2,5 - 16		6 - 35	
	flexible with multicore cable end mm <sup>2</sup>	0,75 - 4	1,5 - 16		6 - 35	
Cables per clamp		1	1		1	
<b>Power consumption of the combination</b>						
	inrush and change-over VA	55	128		178	
	sealed VA	20	26		31	
	W	6	8		11	

1) Suitable for: earthed-neutral systems, overvoltage category I to IV, pollution degree 3 (standard-industry):  $U_{imp} = 8kV$ . Data for other conditions on request.

# Star-Delta Starters

## Wiring Diagrams Main Circuit

Terminal markings of contactors and relays according to DIN EN 50012  
Connections shown in main and circuits as broken lines are not included.

### K3NY15 to K3Y100

with thermal overload relay U3/.. or U12/16

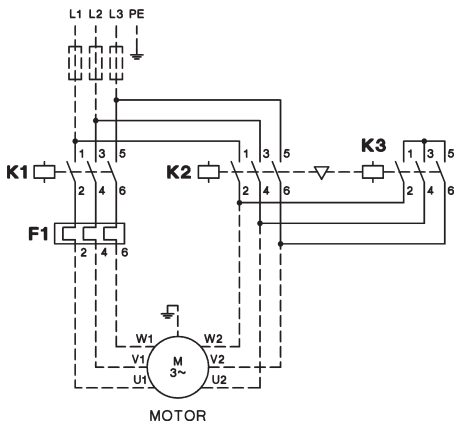

### K3Y140 to K3Y300

with thermal overload relay U85 or U180

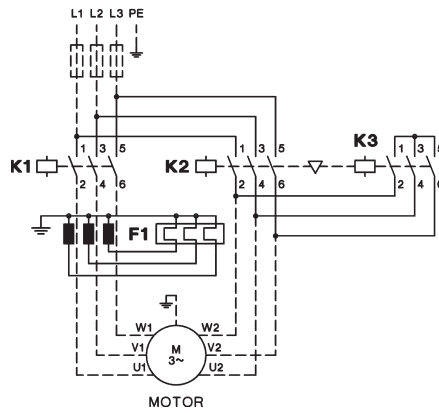

## Wiring Diagrams Control Circuit

### K3NY15 to K3Y52

operating with control switch

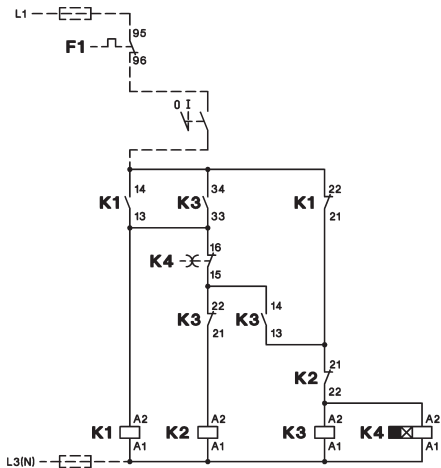

### K3NY15 to K3Y52

operating with push buttons

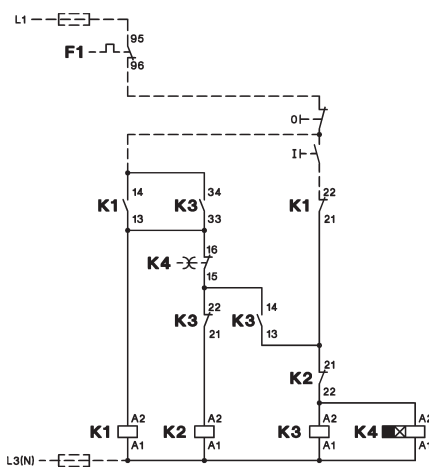

### K3Y80 to K3Y200

operating with control switch

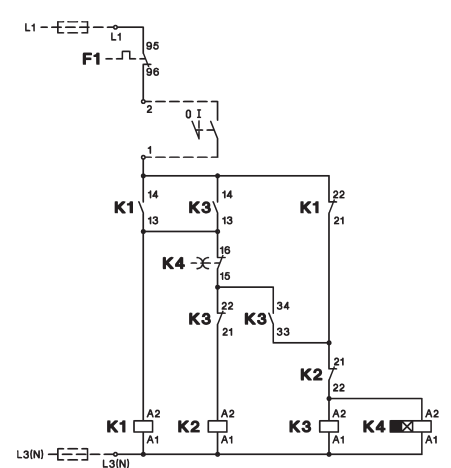

### K3Y80 to K3Y200

operating with push buttons

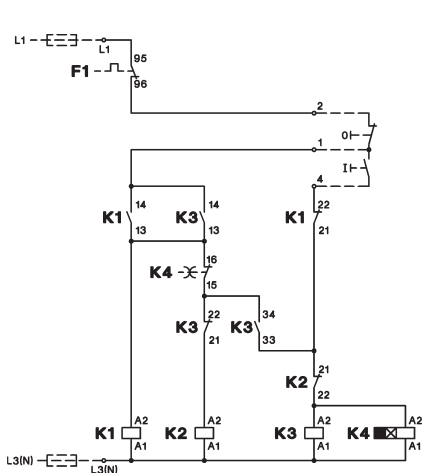

### K3Y240 to K3Y300

operating with control switch

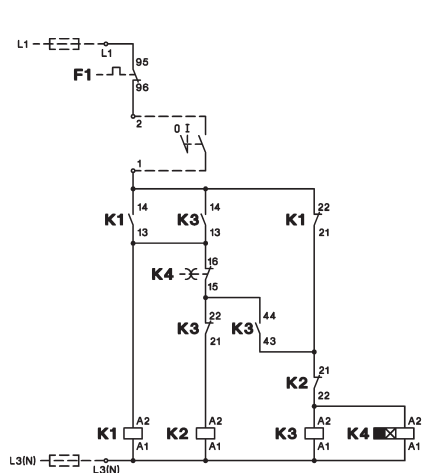

### K3Y240 to K3Y300

operating with push buttons

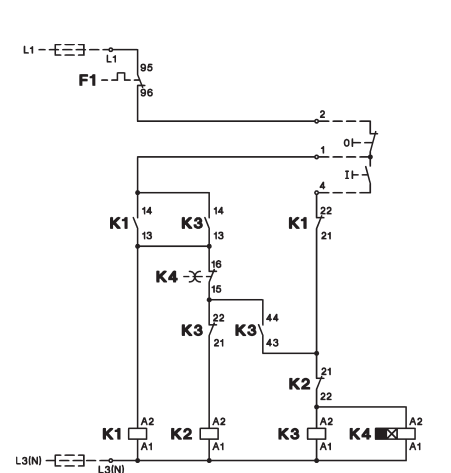

# Star-Delta Starters

## Wiring Diagrams Main Circuit

Terminal markings of contactors and relays according to DIN EN 50012  
 Connections shown in main and control circuits as broken lines are not included.

### K3YL..

Typical circuit diagram

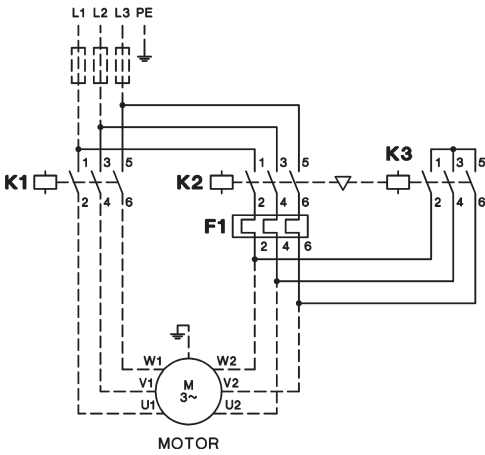

### K3Y.. with 2 Thermal Overload Relays

Typical circuit diagram

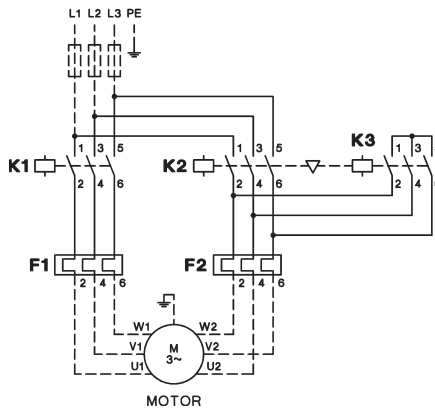

## Wiring Diagrams Control Circuit

### with selector switch

#### K3Y..W

Typical circuit diagram  
 operating with control switch

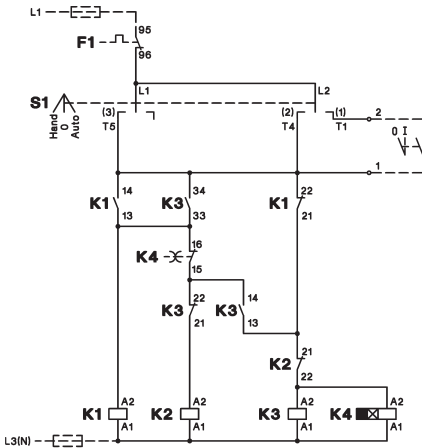

Typical circuit diagram  
 operating with push buttons

### with push buttons

#### K3Y..T

Typical circuit diagram

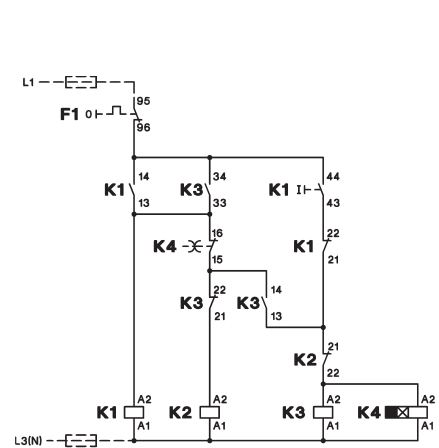
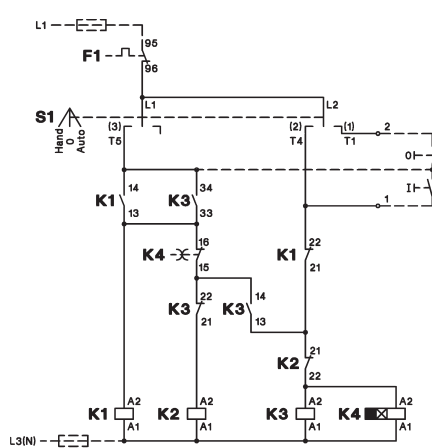

# Reversing Contactors

## Wiring Diagrams Main Circuit

Terminal markings of contactors and relays according to DIN EN 50012  
 Connections shown in main and control circuits as broken lines are not included.

### K3NWU10 to K3WU74

with thermal overload relay U3/32, U3/42 or U3/74

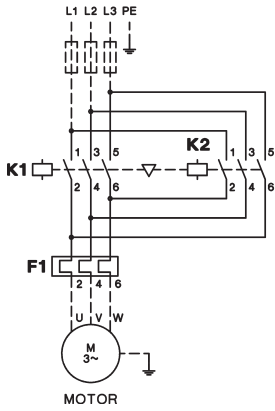

## Wiring Diagrams Control Circuit

### K3NWU10 to K3WU32

operating with control switch

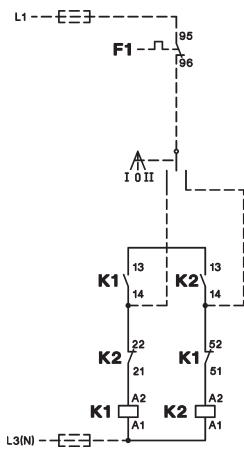

operating with push buttons  
**Reversing over off-position**

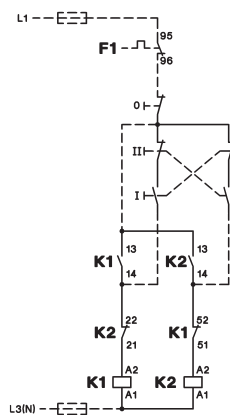

**Reversing direct**

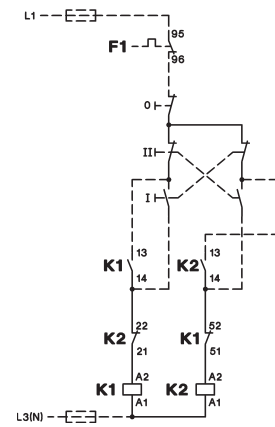

### K3WU50, K3WU62, K3WU74

operating with control switch

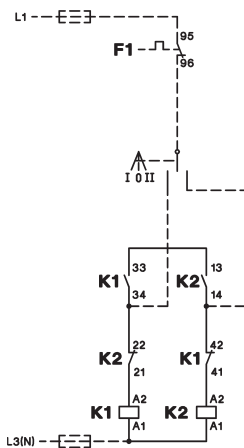

operating with push buttons

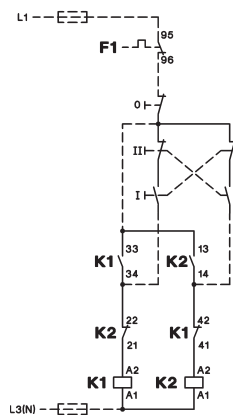



# Pole Changing Starters

## Wiring Diagrams

Terminal markings of contactors and relays according to DIN EN 50012  
 Connections shown in main and control circuits as broken lines are not included.

### Main Circuit

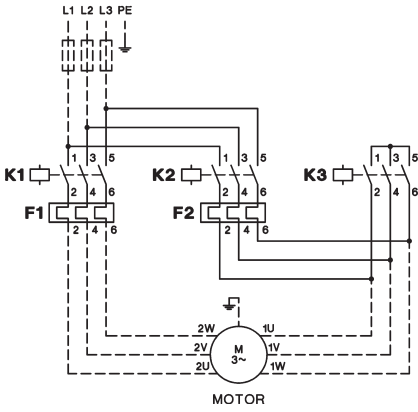

### Principal Control Circuit Wiring Diagram

operating with control switch

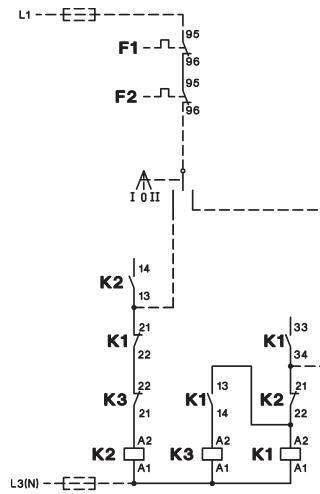

operating with push buttons

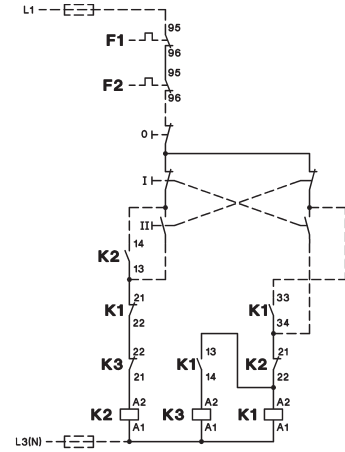

	Low speed	High speed	Low speed	High speed
Operation	Delta	Double-Star	Star	Double-Star
Speed relation	1	2	1	2
Power relation	1	1,5 - 1,8	0,3	1

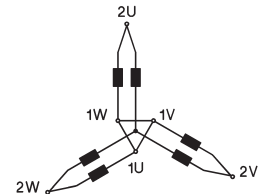
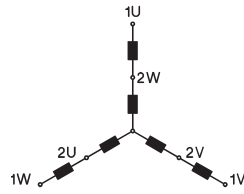
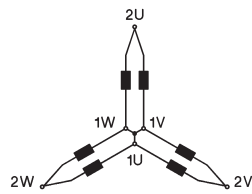
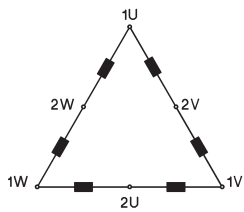

# Star-Delta Starters

## Dimensions

Star-Delta Starters, AC operated, open type

**K3NY15 + U3/32**  
**K3NY26**

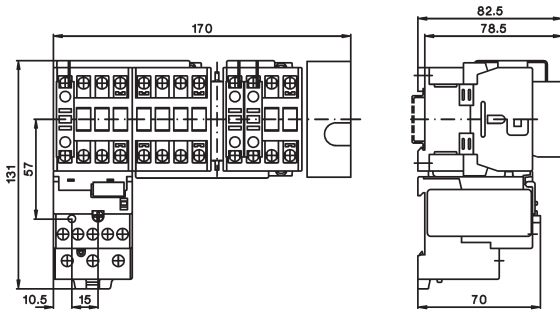

**K3NY15 + U12/16E G3**  
**K3NY26**

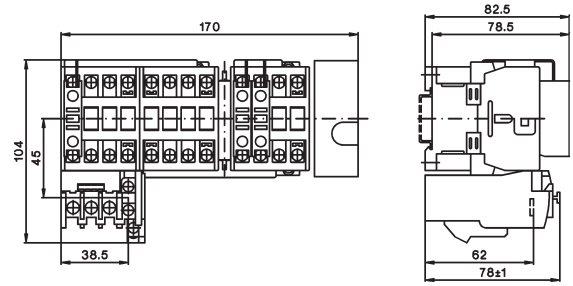

**K3Y40 + U3/32**  
**K3Y52 + U3/32**

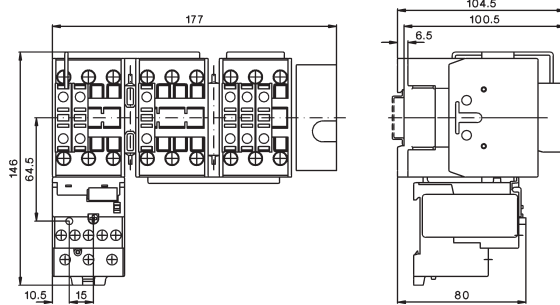

**K3Y40 + U3/42**  
**K3Y52 + U3/42**

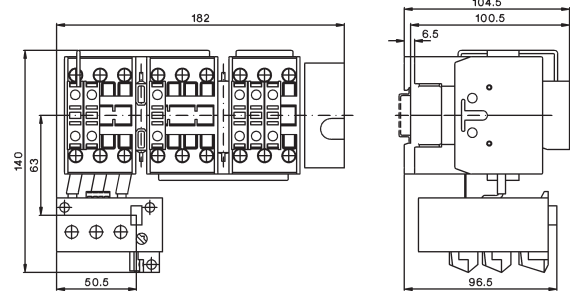

**K3Y80 + U3/74**

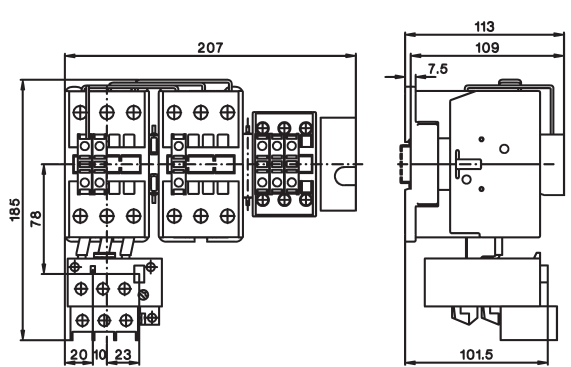

**K3Y100 + U3/74**

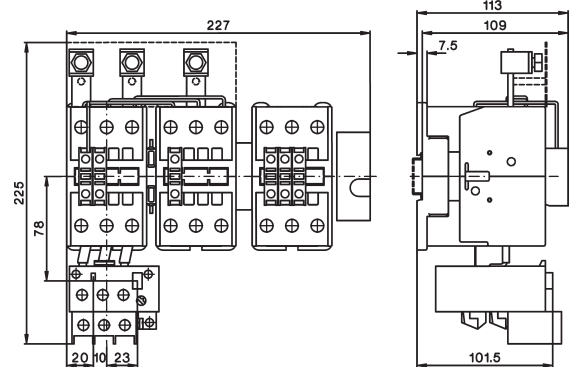

**K3Y140 + U85**  
**K3Y200**

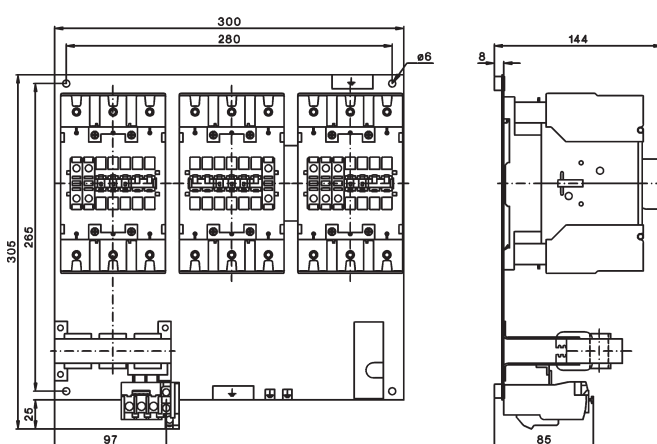

**K3Y240 + U180 + SU180/176**  
**K3Y300**

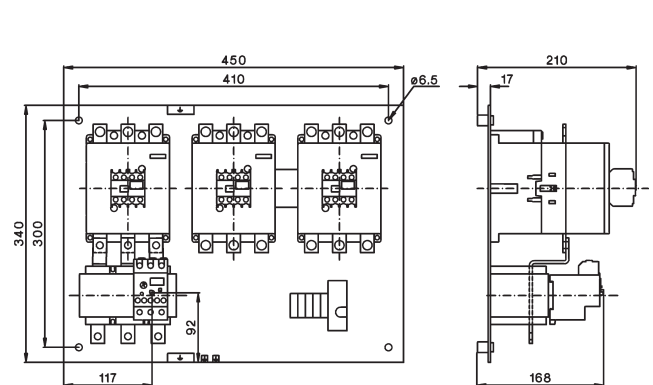

# Star-Delta Starters

## Dimensions

Star-Delta Starters, plastic enclosed, protected to IP65

### K3NY26P

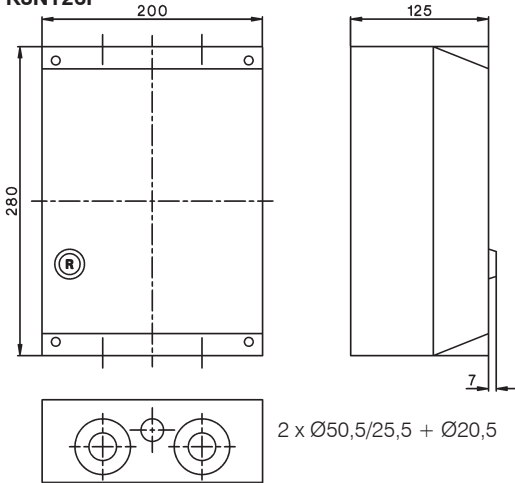

### K3Y40P to K2Y100P

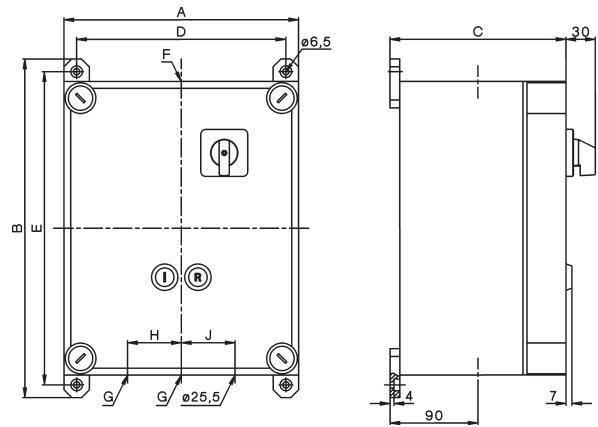

Type	A	B	C	D	E	Ø F	Ø G	H	J	
<b>K3Y40P</b>	300	346	180	272	320	6,5	32,5	32,5	60	60
<b>K3Y52P</b>	300	346	180	272	320	6,5	32,5	32,5	60	60
<b>K3Y80P</b>	300	446	180	272	420	6,5	40,5	40,5	70	70
<b>K3Y100P</b>	300	446	180	272	420	6,5	50,5	40,5	70	70

Star-Delta Starters, sheet steel enclosed, protected to IP54

### K3Y26B to K3Y52B

Type	Ø F	Ø G
<b>K3NY26B</b>	25,5	25,5
<b>K3Y40B</b>	32,5	32,5
<b>K3Y52B</b>	32,5	32,5

Mounting by included fixing link

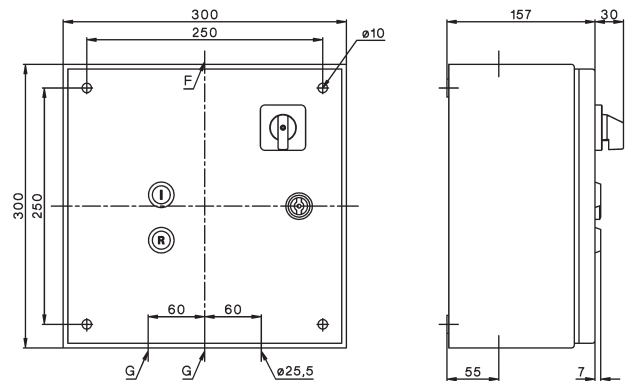
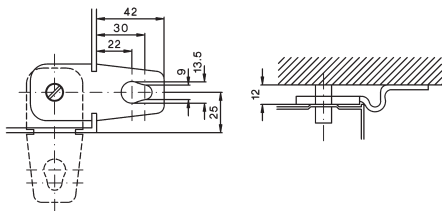

### K3Y80B to K2Y200B

Type	A	B	C	D	E	L	M
<b>K3Y80B</b>	380	380	210	340	340	8,7	65
<b>K3Y100B</b>	380	380	210	340	340	8,7	65
<b>K3Y140B</b>	380	600	210	560	340	8,7	65
<b>K3Y200B</b>	380	600	210	560	340	8,7	65

Type	Ø F	Ø G	H	J	K
<b>K3Y80B</b>	40,5	40,5	70	70	60
<b>K3Y100B</b>	50,5	40,5	80	70	60
<b>K3Y140B</b>	50,5	50,5	80	80	70
<b>K3Y200B</b>	50,5	50,5	80	80	70

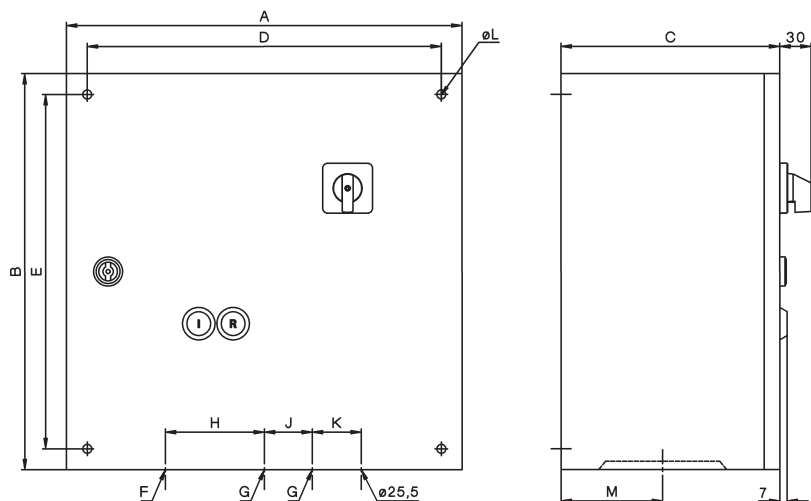

# Reversing Contactors

## Dimensions

Reversing Starters, AC operated, open type

**K3NWU10 + U3/32**  
**K3NWU18**

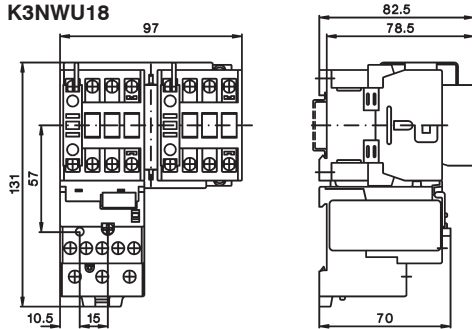

**K3NWU10 + U12/16E G3**  
**K3NWU18**

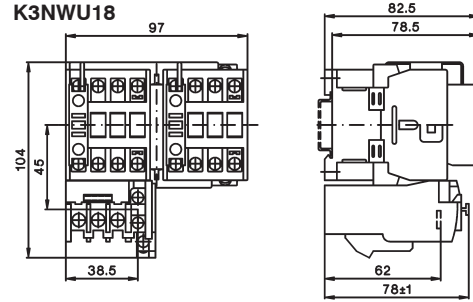

**K3WU24 + U3/32**  
**K3WU32**  
**K3WU40**

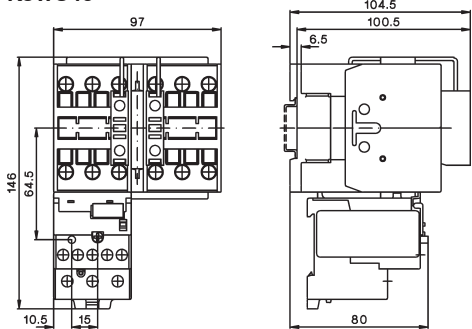

**K3WU24 + U3/42**  
**K3WU32**  
**K3WU40**

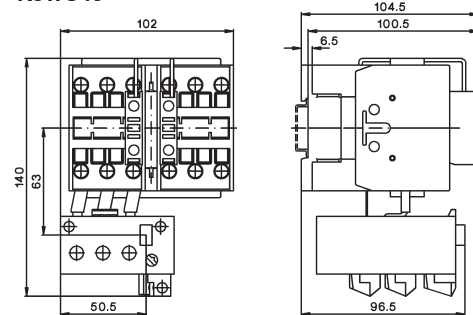

**K3WU50 + U3/74**  
**K3WU62**  
**K3WU74**

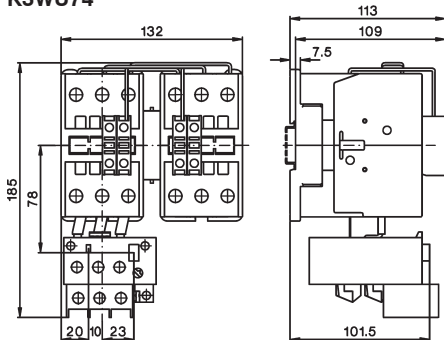

Reversing Contactors, sheet steel enclosed, protected to IP54

Type	A	B	C	D	E	F	G	H	K
<b>K3NWU18B</b>	300	300	150	250	250	30	30	Ø25,5	41
<b>K3WU24B</b>	300	300	150	250	250	30	30	Ø32,5	41
<b>K3WU32B</b>	300	300	150	250	250	30	30	Ø32,5	41
<b>K3WU50B</b>	300	300	150	250	250	40	40	Ø32,5	59
<b>K3WU62B</b>	300	300	150	250	250	40	40	Ø32,5	59

Mounting by included fixing link

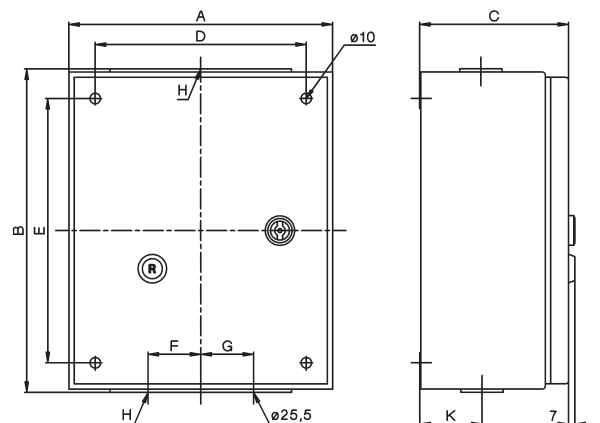
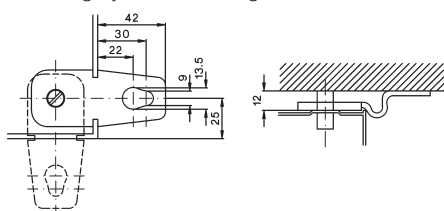

# Pole Changing Starters

## Dimensions

Pole Changing Starters, AC operated, open type

**K3NPU18 + 2x U3/32**

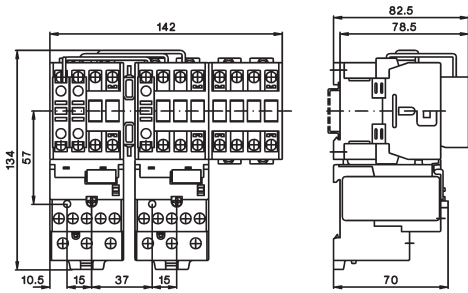

**K3NPU18 + 2x U12/16**

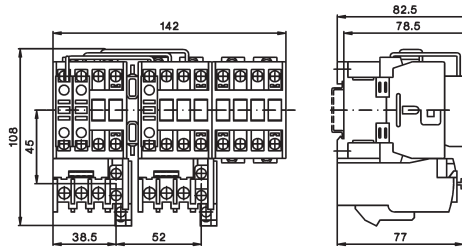

**K3PU24 + 2x U3/32  
K3PU32**

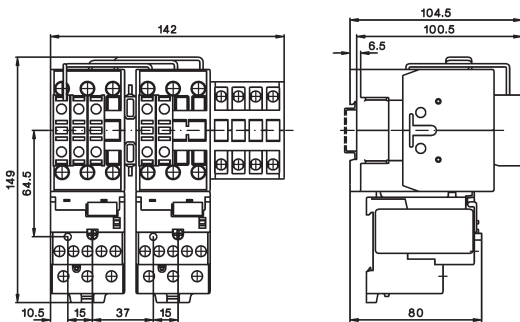

**K3PU50 + 2x U3/74  
K3PU62**

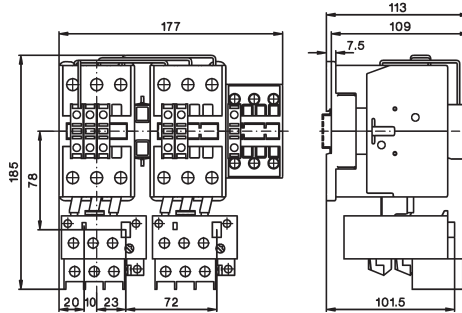

Pole Changing Starters, sheet steel enclosed, protected to IP54

**K3NPU18B to K3PU32B**

Type	Ø F	Ø G
<b>K3NPU18B</b>	25,5	25,5
<b>K3PU24B</b>	32,3	32,5
<b>K3PU32B</b>	32,3	32,5

Mounting by included fixing link

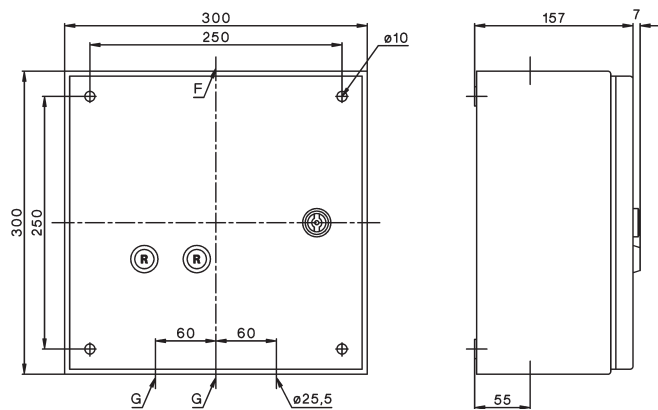
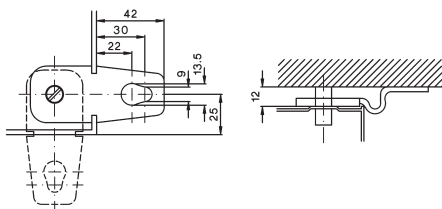



D.O.L. Starters With Start-Stop Buttons

112



D.O.L. Starters With Selector Switch

112



D.O.L. Starters With Selector Switch And Pneumatic Switch For Use In Moist Rooms

112



Enclosures

113



Accessories

113

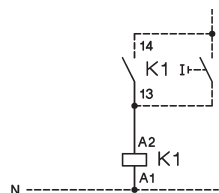

Wiring Diagrams

115

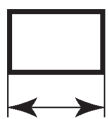

Dimensions

116

## D.O.L. Starters In Plastic Enclosure

Ratings	Included	Free	order	Protec-	Conduit	Type	Coil voltage <sup>1)</sup>	Pack	Weight
AC3 at	Contact	Space	extra	tion	Entries			pcs.	kg/pc.
<b>380V</b>		f. Aux.		Degree			<b>230</b> 220-240V 50Hz		
<b>400V</b>		Cont.	Overload				<b>400</b> 380-415V 50Hz		
<b>415V</b>		HN..	Relay						
<b>kW</b>	Type	pcs.	Type						

## D.O.L. Starters with Start-Stop/Reset Push Buttons



<b>4</b>	K3-10ND10	2	U12/16 K3	IP65	Ø 20,5mm	<b>P1T10</b> ...	1	0,6
<b>7,5</b>	K3-18ND10	2	U12/16 K3	IP65	Ø 20,5mm	<b>P1T18</b> ...	1	0,6
<b>11</b>	K3-22ND10	2	U12/16 K3	IP65	Ø 20,5mm	<b>P1T22</b> ...	1	0,6

## D.O.L. Starters with Selector Switch



<b>4</b>	K3-10ND10	2	U12/16 K3	IP65	Ø 20,5mm	<b>P1W10</b> ...	1	0,6
<b>7,5</b>	K3-18ND10	2	U12/16 K3	IP65	Ø 20,5mm	<b>P1W18</b> ...	1	0,6
<b>11</b>	K3-22ND10	2	U12/16 K3	IP65	Ø 20,5mm	<b>P1W22</b> ...	1	0,6

## D.O.L. Starters with Selector Switch and Pneumatic Switch for moist rooms



<b>7,5</b>	K3-18ND10	2	U12/16 K3	IP65	Ø 20,5mm	<b>P1W18P</b> ...	1	0,6
------------	-----------	---	-----------	------	----------	-------------------	---	-----

Push button and tube on request

**Ordering Example:** D.O.L. Starter with selector switch, plastic enclosed, rated AC3 at 400V 15,5A, rated control voltage 230V 50Hz - **Order Type: P1W18 230 + U12/16E 18 K3**

## Pneumatic Button



						<b>P1LT</b>	1	
--	--	--	--	--	--	-------------	---	--

## Air Pressure Hose



Length 5m						<b>P1LS-5</b>	1	
-----------	--	--	--	--	--	---------------	---	--

## Pneumatic Switch



for refill of D.O.L. Starter P1W.. to P1W..P						<b>P1-LDR</b>	1	0,02
--	--	--	--	--	--	---------------	---	------

## Thermal Overload Relays



Setting range A	Type	Pack pcs.	Weight kg/pc.
0,12 - <b>0,18</b>	<b>U12/16E 0,18 K3</b>	1	0,10
0,18 - <b>0,27</b>	<b>U12/16E 0,27 K3</b>	1	0,10
0,27 - <b>0,4</b>	<b>U12/16E 0,4 K3</b>	1	0,10
0,4 - <b>0,6</b>	<b>U12/16E 0,6 K3</b>	1	0,10
0,6 - <b>0,9</b>	<b>U12/16E 0,9 K3</b>	1	0,10
0,8 - <b>1,2</b>	<b>U12/16E 1,2 K3</b>	1	0,10
1,2 - <b>1,8</b>	<b>U12/16E 1,8 K3</b>	1	0,10
1,8 - <b>2,7</b>	<b>U12/16E 2,7 K3</b>	1	0,10
2,7 - <b>4</b>	<b>U12/16E 4 K3</b>	1	0,10
4 - <b>6</b>	<b>U12/16E 6 K3</b>	1	0,10
6 - <b>9</b>	<b>U12/16E 9 K3</b>	1	0,10
8 - <b>11</b>	<b>U12/16E 11 K3</b>	1	0,10
10 - <b>14</b>	<b>U12/16E 14 K3</b>	1	0,10
13 - <b>18</b>	<b>U12/16E 18 K3</b>	1	0,10
17 - <b>23</b>	<b>U12/16E 23 K3</b>	1	0,10
22 - <b>30</b>	<b>U12/16E 30 K3</b>	1	0,13

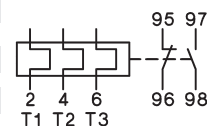

manual reset

## Overload Relays with Quick Tripping Characteristic see page 120,121

Technical data see contactors page 62 and thermal overload relays page 125  
1) Non-standard coil voltages see page 57

## Enclosures for Contactors



Suitable for contactor	Protection Degree	Conduit Entries Top	Conduit Entries Bottom	Type	Pack pcs.	Weight kg/pc.
<b>K3-07.. to K3-22.. K3-24..<sup>1)</sup> to K3-40..<sup>1)</sup></b>	IP65	2 x Ø 20,5mm	2 x Ø 20,5mm	<b>P1</b>	1	0,35

with Reset Button



Suitable for contactor	Protection Degree	Conduit Entries Top	Conduit Entries Bottom	Type	Pack pcs.	Weight kg/pc.
<b>K3-10.. to K3-22.. +U12/16.. K3</b>	IP65	2 x Ø 20,5mm	2 x Ø 20,5mm	<b>P1R</b>	1	0,35

with Selector Switch



Suitable for contactor	Protection Degree	Conduit Entries Top	Conduit Entries Bottom	Type	Pack pcs.	Weight kg/pc.
<b>K3-10.. to K3-22.. +U12/16.. K3</b>	IP65	2 x Ø 20,5mm	2 x Ø 20,5mm	<b>P1W</b>	1	0,35

with Start-Stop Push Button



Suitable for contactor	Protection Degree	Conduit Entries Top	Conduit Entries Bottom	Type	Pack pcs.	Weight kg/pc.
<b>K3-10.. to K3-22.. +U12/16.. K3</b>	IP65	2 x Ø 20,5mm	2 x Ø 20,5mm	<b>P1T</b>	1	0,35

## Indicator Units



Specifications	Voltage Range	Type	Pack pcs.	Weight kg/pc.
<b>Coil Current Indicator</b> , green (LED)	24 - 660V AC/DC	<b>K2-ING</b>	10	0,02
<b>Coil Current Indicator</b> , red (LED)	24 - 660V AC/DC	<b>K2-INR</b>	10	0,02
To be connected in series with the contactor coil. In case of coil interruption the indicator goes out. Voltage drop approx. 2 volts				
<b>Voltage Indicator</b> , clear (glow-disc. I.)	220 - 415V AC/DC	<b>K2-UN</b>	10	0,02
<b>Voltage Indicator</b> , red (LED)	24 - 120V AC/DC	<b>K2-UNR</b>	10	0,02
To be connected parallel to the contactor coil. In case of applied voltage the indicator also lights at coil interruption.				

### Lens Caps For Indicator Units

Lens cap transparent	<b>LG9743T</b>	10	0,005
Lens cap red	<b>LG9743R</b>	10	0,005
Lens cap green	<b>LG9743GR</b>	10	0,005

Mounting instructions see page 118

## Heating Element



Specifications	Voltage Range	Power Consumption	Type	Pack pcs.	Weight kg/pc.
To avoid condensed water on places where high humidity is given together with alterations of ambient temperature	380 - 415V	1,5W	<b>K2-HR</b>	10	0,02
	220 - 240V	1,5W	<b>K2-HR 230</b>	10	0,02

## Additional Terminals, Start Contact



Specification	Cable Cross-sections to clamp mm <sup>2</sup>			Type	Pack pcs.	Weight kg/pc.
	solid or stranded	flexible	flexib. w. multi-core cable end			
<b>Neutral Terminal</b>	2 x 0,75-4	2 x 0,75-2,5	2 x 0,5-2,5	<b>LG9744</b>	10	0,009
<b>Earth Terminal</b>	2,5-16	1,5-10	1,5-10	<b>LG9750</b>	10	0,052
Mounting instructions see page 116						
<b>Start Contact</b>	for contactor K3-10 to K3-22	to be snapped on top of the auxiliary contact		<b>LG9319-K3</b>	10	0,03

<sup>1)</sup> without auxiliary contact blocks



# D.O.L. Starters

## Wiring Diagrams Main Circuit

All fuses F0 shown in the main circuits are not included.  
Terminal markings according to EN 50012

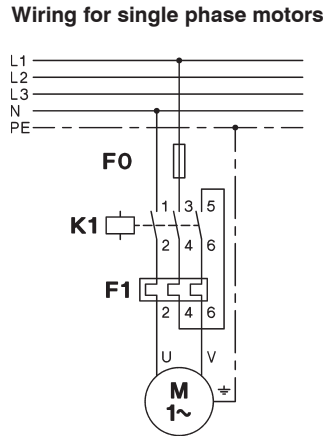
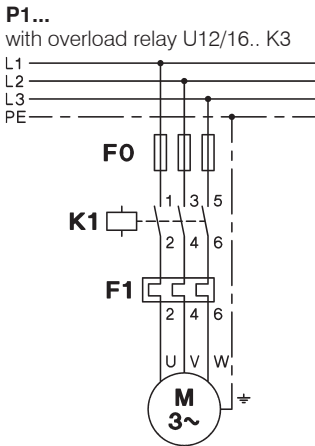

## Wiring Diagrams Control Circuit

D.O.L. Starters P1 with standard coil voltages (see page 94) are supplied with connectors between main circuit and control circuit.

### Coil connectors

Coils for **380-415V 50Hz** and **400-440V 60Hz**: The starter is supplied with control circuit connectors between terminals 1 (L1) and 5 (L3).  
Coils for **220-240V 50Hz** and **230-264V 60Hz**: The starter is supplied with control circuit connectors between terminals 95 and 5 (L3). Connect neutral wire to terminal A1.  
Coils for **other voltages**: Without connectors between supply and control circuit. Connect supply to terminals A1 and 95.

### Separate coil supply

Coils for **380-415V 50Hz** and **400-440V 60Hz**: Remove connectors A1-1 and 95-5, connect supply to terminals A1 and 95.  
Coils for **220-240V 50Hz** and **230-264V 60Hz**: Remove connectors 95-5 connect supply to terminals A1 and 95.  
Coils for **other voltages**: Connect supply to terminals A1 and 95.

### Coil phase to phase (380-415V 50Hz)

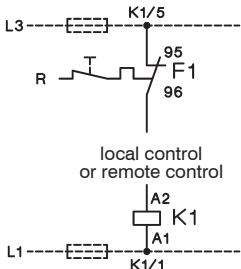

### Coil phase to neutral (220-240V 50Hz)

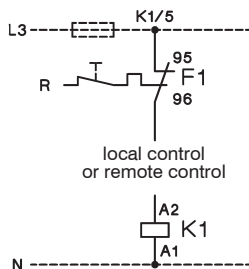

### Coil phase to phase

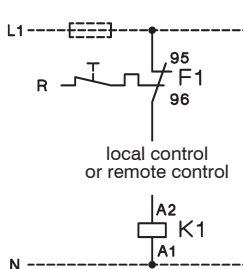

### Coil phase to neutral

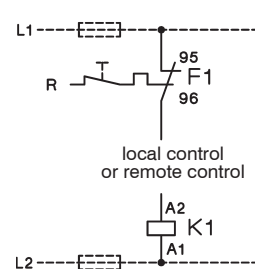

## D.O.L. Starters with remote control

**P1..**  
Remote 2-wire (switch) control

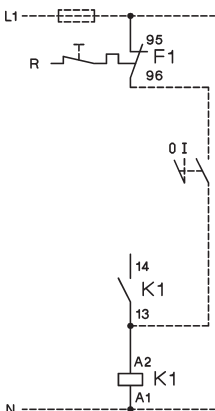

Remote 3-wire (push button) control

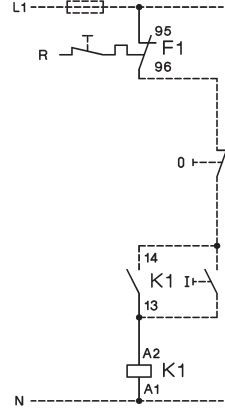

Remote start-stop control  
(3 control stations)

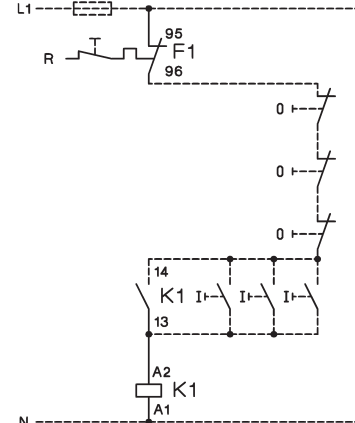

# D.O.L. Starters

## Wiring Diagrams Control Circuits

Typical circuit diagram (for separate coil supply, control circuit connected between L1 and N)  
Terminal markings according to EN 50012

### D.O.L. Starters with Start-Stop/Reset Push Buttons

**P1T10, P1T18, P1T22**  
with overload relay U12/16.. K3

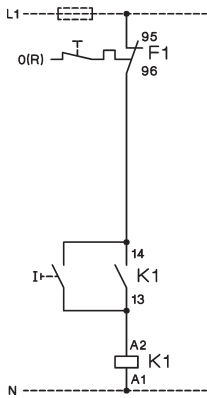

**P1T10, P1T18, P1T22**  
with external push buttons

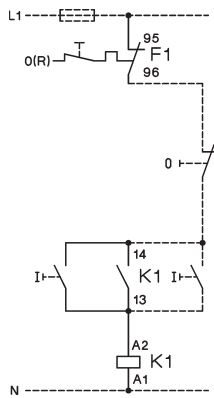

### D.O.L. Starters with Selector Switch

**P1W10, P1W18, P1W22**  
with external control switch

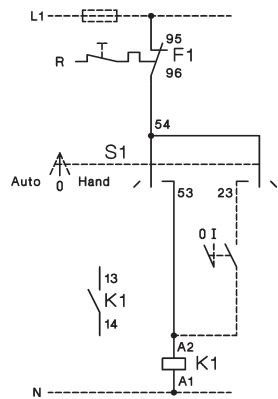

**P1W10, P1W18, P1W22**  
with external push buttons

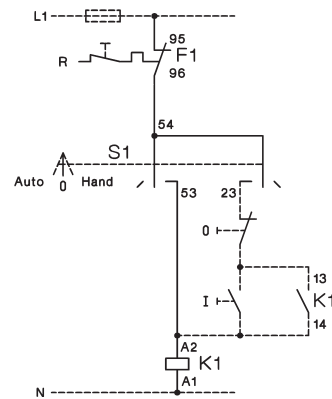

### D.O.L. Starters with Selector Switch and Pneumatic Switch for Swimmingpool Control Gear and for use in Moist Rooms

**P1W18P**  
with overload relay U12/16.. K3

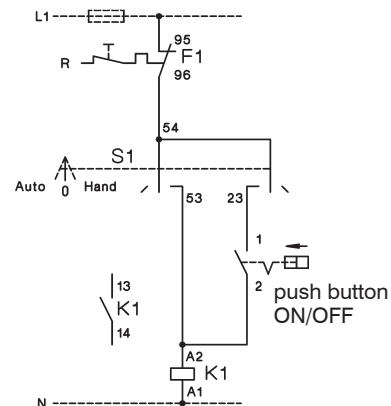

# D.O.L. Starters

## Dimensions

D.O.L. Starters with Start-Stop/Reset Push Buttons, Plastic Enclosed

P1T., P1TP.

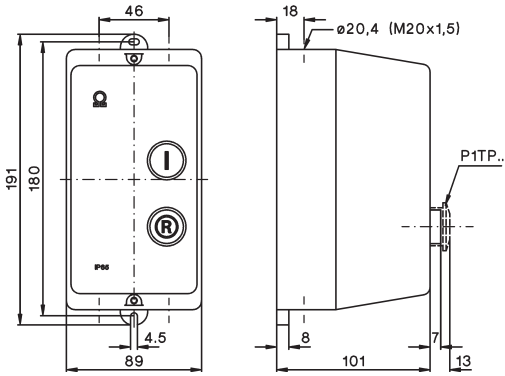

D.O.L. Starters with Selector Switch, Plastic Enclosed

P1W., P1W18P

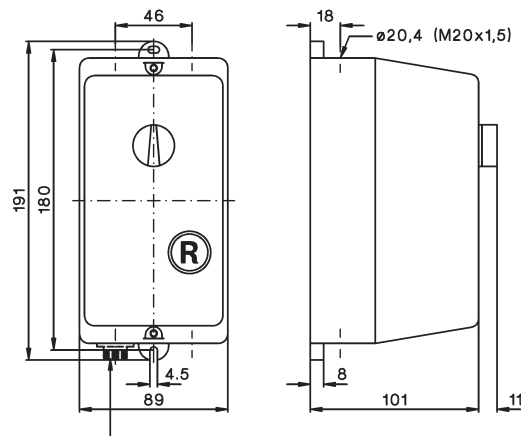

P1W18P: plug-in for air tube inside diameter 3mm

## Rear Conduit Entries

knockouts  
4 x Ø 23

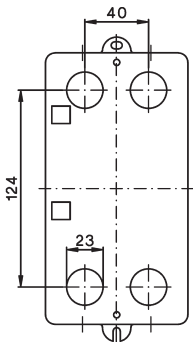

## Earth Terminal LG9750 for K2-23 and K2-30 in Enclosure P1

for K2-23 and K2-30 remove spacing piece

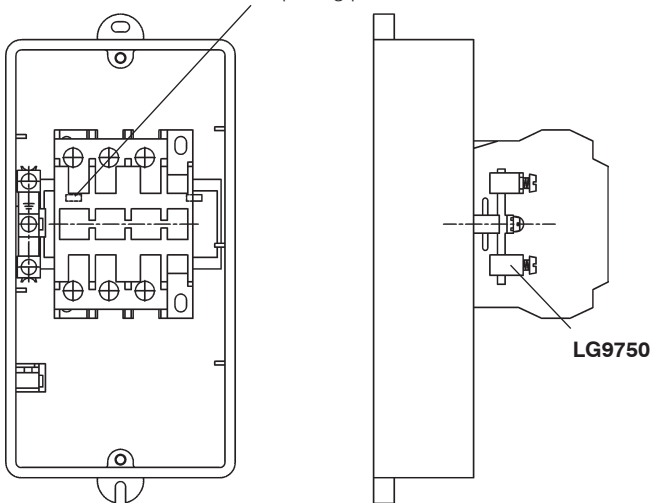

## Neutral Terminal LG9744

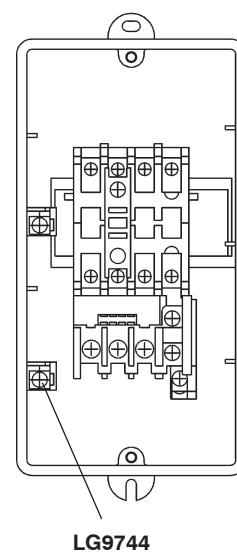

# Enclosures

## Dimensions

### Enclosures for Contactors

P1

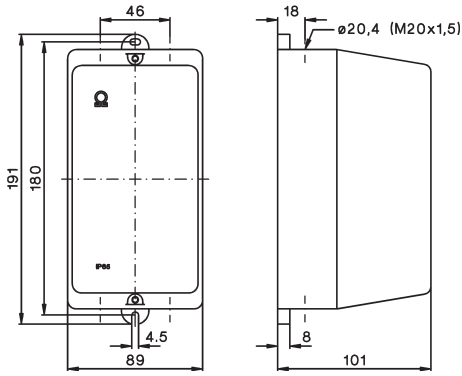

### Enclosures for D.O.L. Starters

P1R, P1P

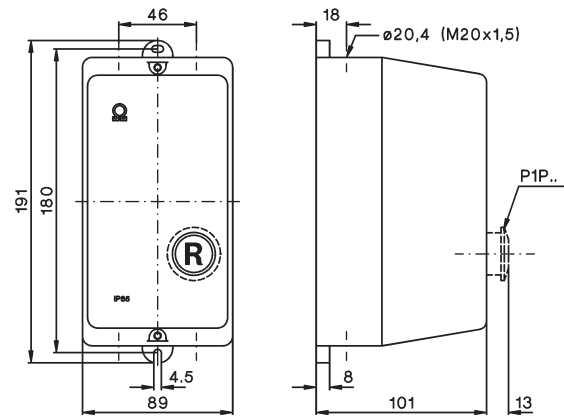

### Rear Conduit Entries

knockouts  
4 x  $\phi 23$

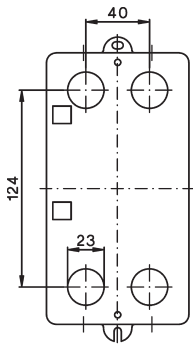

# D.O.L. Starters

## Mounting and Wiring Instructions

Indicators and Lens Caps for D.O.L. Starters P1

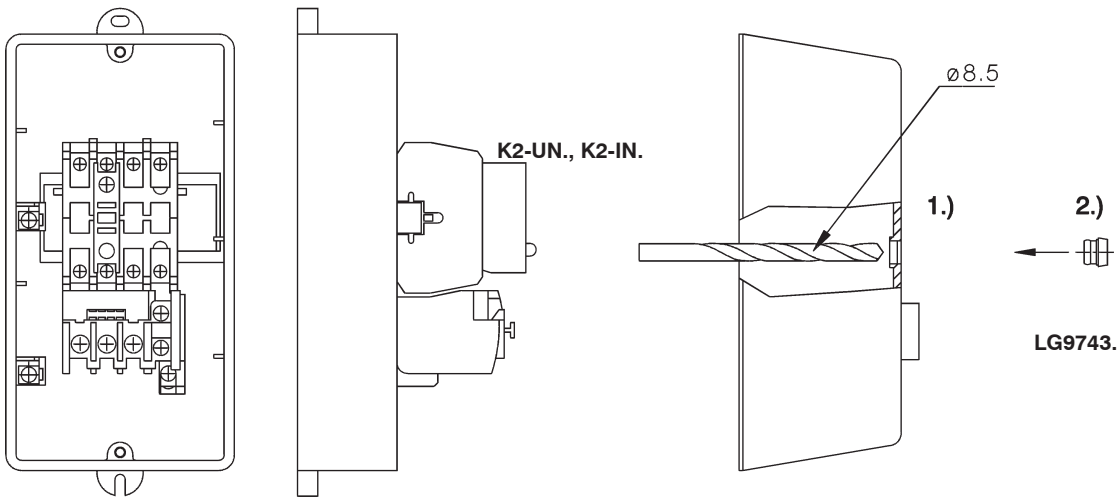

### Wiring Examples

#### Coil Current Indicator

K2-ING  
K2-INR

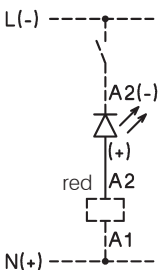

#### Voltage Indicator

K2-UN  
K2-UNR

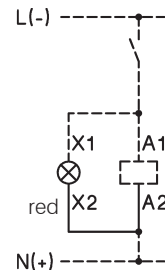

#### Heating Element

K2-HR

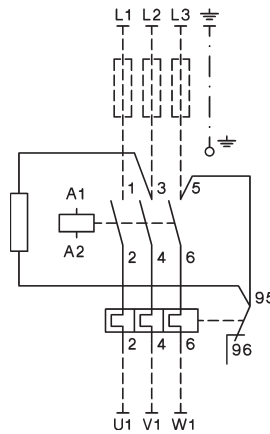

K2-HR 230

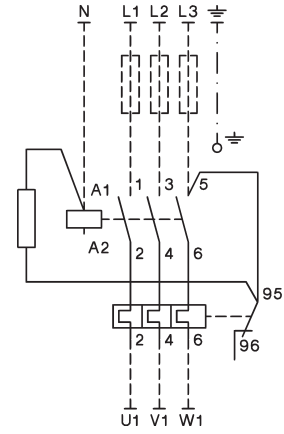

Colour mentioned in wiring diagrams refer to the outgoing connection wire of the device.

Start Contact LG9319-K3 for K3-10ND10 up to K3-22ND10

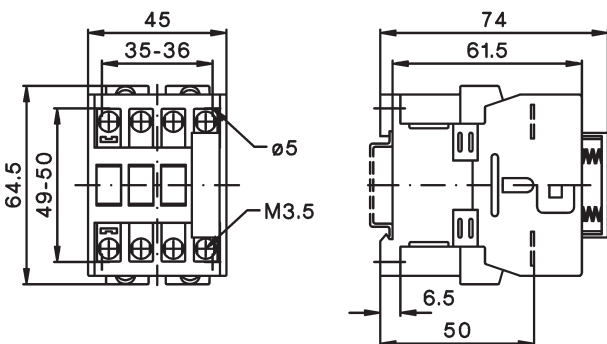



Thermal Overload Relays for Direct Mounting

120

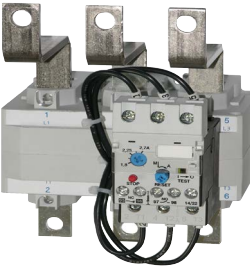

Thermal Overload Relays for Separate Mounting

122



Accessories

123



Technical Data

125

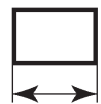

Dimensions

129

# Thermal Overload Relays for plug-in mounting

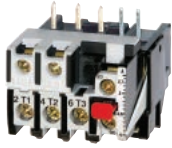

**Setting Range**  
D.O.L. (A)  $\Upsilon\Delta$  (A)

**Type**

Pack Weight  
pcs. kg/pc.

Wiring Diagram

## With Manual Reset, for contactors K1-..

0,12 - <b>0,18</b>	-		<b>U12/16E 0,18 K1</b>	1	0,10
0,18 - <b>0,27</b>	-		<b>U12/16E 0,27 K1</b>	1	0,10
0,27 - <b>0,4</b>	-		<b>U12/16E 0,4 K1</b>	1	0,10
0,4 - <b>0,6</b>	-		<b>U12/16E 0,6 K1</b>	1	0,10
0,6 - <b>0,9</b>	-		<b>U12/16E 0,9 K1</b>	1	0,10
0,8 - <b>1,2</b>	-		<b>U12/16E 1,2 K1</b>	1	0,10
1,2 - <b>1,8</b>	-		<b>U12/16E 1,8 K1</b>	1	0,10
1,8 - <b>2,7</b>	-		<b>U12/16E 2,7 K1</b>	1	0,10
2,7 - <b>4</b>	-		<b>U12/16E 4 K1</b>	1	0,10
4 - <b>6</b>	7 - 10,5		<b>U12/16E 6 K1</b>	1	0,10
6 - <b>9</b>	10,5 - 15,5		<b>U12/16E 9 K1</b>	1	0,10
8 - <b>11</b>	14 - 19		<b>U12/16E 11 K1</b>	1	0,10
10 - <b>14</b>	18 - 24		<b>U12/16E 14 K1</b>	1	0,10

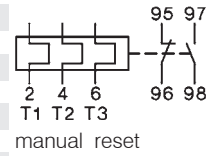

## With Auto Reset, for contactors K1-..

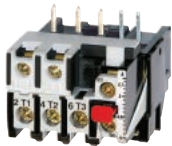

0,12 - <b>0,18</b>	-		<b>U12/16A 0,18 K1</b>	1	0,10
0,18 - <b>0,27</b>	-		<b>U12/16A 0,27 K1</b>	1	0,10
0,27 - <b>0,4</b>	-		<b>U12/16A 0,4 K1</b>	1	0,10
0,4 - <b>0,6</b>	-		<b>U12/16A 0,6 K1</b>	1	0,10
0,6 - <b>0,9</b>	-		<b>U12/16A 0,9 K1</b>	1	0,10
0,8 - <b>1,2</b>	-		<b>U12/16A 1,2 K1</b>	1	0,10
1,2 - <b>1,8</b>	-		<b>U12/16A 1,8 K1</b>	1	0,10
1,8 - <b>2,7</b>	-		<b>U12/16A 2,7 K1</b>	1	0,10
2,7 - <b>4</b>	-		<b>U12/16A 4 K1</b>	1	0,10
4 - <b>6</b>	7 - 10,5		<b>U12/16A 6 K1</b>	1	0,10
6 - <b>9</b>	10,5 - 15,5		<b>U12/16A 9 K1</b>	1	0,10
8 - <b>11</b>	14 - 19		<b>U12/16A 11 K1</b>	1	0,10
10 - <b>14</b>	18 - 24		<b>U12/16A 14 K1</b>	1	0,10

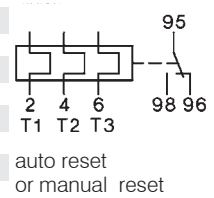

## With Quick Tripping Characteristic for EEx e motors and submersible pumps, f. contactors K1-..

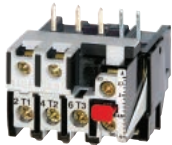

0,4 - <b>0,6</b>	-		<b>U12/16EQ 0,6 K1</b>	1	0,10
0,6 - <b>0,9</b>	-		<b>U12/16EQ 0,9 K1</b>	1	0,10
0,8 - <b>1,2</b>	-		<b>U12/16EQ 1,2 K1</b>	1	0,10
1,2 - <b>1,8</b>	-		<b>U12/16EQ 1,8 K1</b>	1	0,10
1,8 - <b>2,7</b>	-		<b>U12/16EQ 2,7 K1</b>	1	0,10
2,7 - <b>4</b>	-		<b>U12/16EQ 4 K1</b>	1	0,10
4 - <b>6</b>	7 - 10,5		<b>U12/16EQ 6 K1</b>	1	0,10
6 - <b>9</b>	10,5 - 15,5		<b>U12/16EQ 9 K1</b>	1	0,10
8 - <b>11</b>	14 - 19		<b>U12/16EQ 11 K1</b>	1	0,10

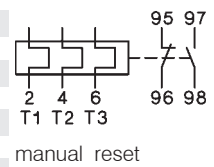

# Thermal Overload Relays for plug-in mounting

Contactors, Motor-Starters  
 Circuit Breakers  
 Manual Motor-Starters  
 Switches  
 AC-Main Switches  
 DC-Switch Disconnectors  
 Push Buttons  
 Representatives, Suppliers

Setting Range      Type      Pack      Weight  
 D.O.L. (A)       $\Upsilon\Delta$  (A)      pcs.      kg/pc.      Wiring Diagram

**With Manual Reset**, for contactors K(G)3-10.. to K(G)3-22.. ..

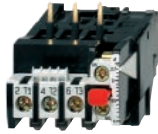

0,12 - <b>0,18</b>	-		<b>U12/16E 0,18 K3</b>	1	0,10
0,18 - <b>0,27</b>	-		<b>U12/16E 0,27 K3</b>	1	0,10
0,27 - <b>0,4</b>	-		<b>U12/16E 0,4 K3</b>	1	0,10
0,4 - <b>0,6</b>	-		<b>U12/16E 0,6 K3</b>	1	0,10
0,6 - <b>0,9</b>	-		<b>U12/16E 0,9 K3</b>	1	0,10
0,8 - <b>1,2</b>	-		<b>U12/16E 1,2 K3</b>	1	0,10
1,2 - <b>1,8</b>	-		<b>U12/16E 1,8 K3</b>	1	0,10
1,8 - <b>2,7</b>	-		<b>U12/16E 2,7 K3</b>	1	0,10
2,7 - <b>4</b>	-		<b>U12/16E 4 K3</b>	1	0,10
4 - <b>6</b>	7 - 10,5		<b>U12/16E 6 K3</b>	1	0,10
6 - <b>9</b>	10,5 - 15,5		<b>U12/16E 9 K3</b>	1	0,10
8 - <b>11</b>	14 - 19		<b>U12/16E 11 K3</b>	1	0,10
10 - <b>14</b>	18 - 24		<b>U12/16E 14 K3</b>	1	0,10
13 - <b>18</b>	23 - 31		<b>U12/16E 18 K3</b>	1	0,10
17 - <b>23</b>	30 - 40		<b>U12/16E 23 K3</b>	1	0,10
22 - <b>30</b>	38 - 52		<b>U12/16E 30 K3</b>	1	0,13

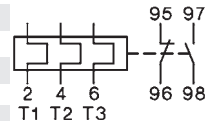

manual reset

**With quick Tripping Characteristic** for EEx e motors and under water pumps



0,4 - <b>0,6</b>	-		<b>U12/16EQ 0,6 K3</b>	1	0,10
0,6 - <b>0,9</b>	-		<b>U12/16EQ 0,9 K3</b>	1	0,10
0,8 - <b>1,2</b>	-		<b>U12/16EQ 1,2 K3</b>	1	0,10
1,2 - <b>1,8</b>	-		<b>U12/16EQ 1,8 K3</b>	1	0,10
1,8 - <b>2,7</b>	-		<b>U12/16EQ 2,7 K3</b>	1	0,10
2,7 - <b>4</b>	-		<b>U12/16EQ 4 K3</b>	1	0,10
4 - <b>6</b>	7 - 10,5		<b>U12/16EQ 6 K3</b>	1	0,10
6 - <b>9</b>	10,5 - 15,5		<b>U12/16EQ 9 K3</b>	1	0,10
8 - <b>11</b>	14 - 19		<b>U12/16EQ 11 K3</b>	1	0,10
10 - <b>14</b>	18 - 24		<b>U12/16EQ 14 K3</b>	1	0,10

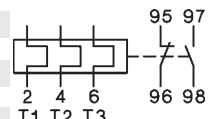

manual reset

For contactors K(G)3-10.. to K(G)3-40A..



0,12 - <b>0,18</b>	-		<b>U3/32 0,18</b>	1	0,14
0,18 - <b>0,27</b>	-		<b>U3/32 0,27</b>	1	0,14
0,27 - <b>0,4</b>	-		<b>U3/32 0,4</b>	1	0,14
0,4 - <b>0,6</b>	-		<b>U3/32 0,6</b>	1	0,14
0,6 - <b>0,9</b>	-		<b>U3/32 0,9</b>	1	0,14
0,8 - <b>1,2</b>	-		<b>U3/32 1,2</b>	1	0,14
1,2 - <b>1,8</b>	-		<b>U3/32 1,8</b>	1	0,14
1,8 - <b>2,7</b>	-		<b>U3/32 2,7</b>	1	0,14
2,7 - <b>4</b>	-		<b>U3/32 4</b>	1	0,14
4 - <b>6</b>	7 - 10,5		<b>U3/32 6</b>	1	0,14
6 - <b>9</b>	10,5 - 15,5		<b>U3/32 9</b>	1	0,14
8 - <b>11</b>	14 - 19		<b>U3/32 11</b>	1	0,14
10 - <b>14</b>	18 - 24		<b>U3/32 14</b>	1	0,14
13 - <b>18</b>	23 - 31		<b>U3/32 18</b>	1	0,14
17 - <b>24</b>	30 - 41		<b>U3/32 24</b>	1	0,14
23 - <b>32</b>	40 - 55		<b>U3/32 32</b>	1	0,14

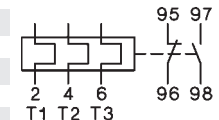

manual and auto reset

For contactors K(G)3-24A.. to K(G)3-40A ..



10 - <b>14</b>	18 - 24		<b>U3/42 14</b>	1	0,30
14 - <b>20</b>	24 - 35		<b>U3/42 20</b>	1	0,30
20 - <b>28</b>	35 - 48		<b>U3/42 28</b>	1	0,30
28 - <b>42</b>	48 - 73		<b>U3/42 42</b>	1	0,30

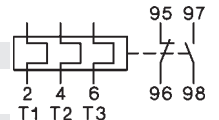

manual and auto reset



## Thermal Overload Relays for plug-in mounting



Setting Range		$\Delta$ (A)	Type	Pack pcs.	Weight kg/pc.
D.O.L.	(A)				
For contactors K3-50A.. to K3-74A..					
20 - <b>28</b>	35 - 48		<b>U3/74 28</b>	1	0,40
28 - <b>42</b>	48 - 73		<b>U3/74 42</b>	1	0,40
40 - <b>52</b>	70 - 90		<b>U3/74 52</b>	1	0,40
52 - <b>65</b>	90 - 112		<b>U3/74 65</b>	1	0,40
60 - <b>74</b>	104 - 128		<b>U3/74 74</b>	1	0,40

Wiring Diagram

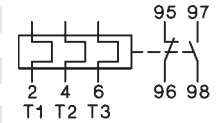

manual and auto reset

## Thermal Overload Relays for separate mounting

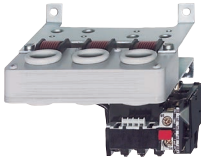

Setting Range		$\Delta$ (A)	Type	Pack pcs.	Weight kg/pc.
D.O.L.	(A)				
For contactors K3-90, K3-115, K85, K110					
60 - <b>90</b>	104 - 156		<b>U85 90</b>	1	0,90
80 - <b>120</b>	140 - 207		<b>U85 120</b>		

Wiring Diagram

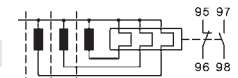

manual reset



For contactors K3-151.. and K3-176.., busbars included

120 - <b>180</b>	208 - 312		<b>U180 180</b>	1	1,5
------------------	-----------	--	-----------------	---	-----

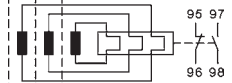

manual and auto reset



For contactors K3-210.. up to K3-316.., busbars included

144 - <b>216</b>	250 - 374		<b>U320 216</b>	1	1,8
216 - <b>320</b>	374 - 554		<b>U320 320</b>		

manual and auto reset

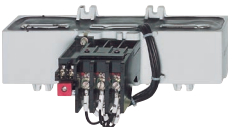

For contactors K3-315.., K3-450.., K3-550.., K3-700.., K3-860..

240 - <b>360</b>	416 - 623		<b>U800 360</b>	1	4,1
360 - <b>540</b>	623 - 935		<b>U800 540</b>	1	4,1
540 - <b>800</b>	935 - 1385		<b>U800 800</b>	1	4,1

### With Slow Tripping Characteristic for heavy duty starting with long run up times

For separate mounting, suitable for all contactors

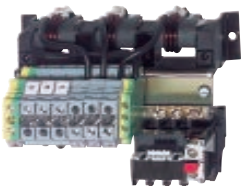

0,8 - <b>1,2</b>	1,2 - 2,1		<b>UAT21 1,2</b>	1	1,0
1,2 - <b>1,8</b>	2,1 - 3,1		<b>UAT21 1,8</b>	1	1,0
1,6 - <b>2,4</b>	2,8 - 4,2		<b>UAT21 2,4</b>	1	1,0
2,4 - <b>3,7</b>	4,2 - 6,4		<b>UAT21 3,7</b>	1	1,0
3,7 - <b>5,7</b>	6,4 - 9,9		<b>UAT21 5,7</b>	1	1,0
5,3 - <b>8,2</b>	9,2 - 14,2		<b>UAT21 8,2</b>	1	1,0
8 - <b>12</b>	13,9 - 20,1		<b>UAT21 12</b>	1	1,0
12 - <b>18</b>	20,1 - 31,2		<b>UAT21 18</b>	1	1,0
16 - <b>24</b>	27,7 - 41,6		<b>UAT22 24</b>	1	1,1
24 - <b>37</b>	41,6 - 64		<b>UAT23 37</b>	1	1,3
32 - <b>49</b>	55,4 - 85		<b>UAT23 49</b>	1	1,3
48 - <b>72</b>	83 - 125		<b>UAT23 72</b>	1	1,3

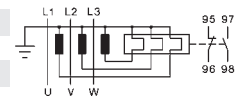

manual reset

## Accessories



for overload relays      for contactors

		Type	Pack set	Weight kg/set
--	--	------	----------	---------------

### Busbar Sets

U800	K3-450.., K3-550..	<b>SU840/550</b>	1	1,7
U800	K3-700.., K3-860..	<b>SU840/860</b>	1	2,1

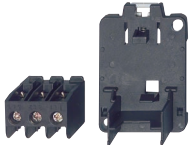

Cable Cross-section (mm <sup>2</sup> )		Type		Pack pcs.	Weight kg/pc.
overload relay	solid or stranded	flexible			

### for Single Mounting U12/16..K3 Base for DIN-rail mounting plus terminals

U12/16..K3	0,75 - 6	0,75 - 4	<b>U12SM K3</b>	1	0,035
------------	----------	----------	-----------------	---	-------



### for Single Mounting U3/32 Additional Terminals with fingertouch protection (U3/32 relays have base for DIN rail mounting integrated)

U3/32	0,75 - 6	0,75 - 4	<b>U3/32SM</b>	1	0,035
-------	----------	----------	----------------	---	-------



### for Single Mounting U3/42 or U3/74 Base for DIN-rail mounting

U3/42, U3/74	-	-	<b>U3/42G</b>	1	0,030
--------------	---	---	---------------	---	-------



### for Single Mounting U3/42 or U3/74 Connecting Wire Set (3 pcs.)

U3/42, U3/74	150mm length	10mm <sup>2</sup>	<b>LG5830-4</b>	1	0,060
U3/42, U3/74	250mm length	10mm <sup>2</sup>	<b>LG5830-2</b>	1	0,100



### Additional Terminals with fingertouch protection

1-pole f. U12/16, U3/32	0,75 - 10	0,75 - 6	<b>LG9339</b>	1	0,009
3-pole for U3/42	4 - 35	6 - 25	<b>LG7559</b>	1	0,052

# Thermal Overload Relays, tripping times for selection to motors of protection degree EEx e

## Relays With Standard Tripping Characteristic

**Setting Range** Tripping time depending on the multiple of the current setting from cold condition (tolerance  $\pm 20\%$  of the tripping time)

A	A	$I_A/I_N$ 3	$I_A/I_N$ 4	$I_A/I_N$ 5	$I_A/I_N$ 6	$I_A/I_N$ 7,2	$I_A/I_N$ 8
<b>U3/32 ..</b>							
0,12 -	<b>0,18</b>	16,1	9,6	6,8	5,3	4,2	3,7
0,18 -	<b>0,27</b>	16,6	9,7	6,7	5,2	4,1	3,6
0,27 -	<b>0,4</b>	19,4	11,4	7,9	6,1	4,7	4,2
0,4 -	<b>0,6</b>	18,7	10,9	7,6	5,9	4,6	4,0
0,6 -	<b>0,9</b>	19,2	11,2	7,7	5,9	4,6	4,1
0,8 -	<b>1,2</b>	20,8	12,3	8,5	6,6	5,2	4,6
1,2 -	<b>1,8</b>	25,5	14,1	9,8	7,6	5,9	5,2
1,8 -	<b>2,7</b>	26,6	15,6	10,9	8,3	6,5	5,7
2,7 -	<b>4</b>	22,7	13,6	9,5	7,4	5,8	5,1
4 -	<b>6</b>	22,2	13,3	9,3	7,1	5,6	4,9
6 -	<b>9</b>	20,4	11,9	8,2	6,1	4,7	4,0
8 -	<b>11</b>	20,9	11,8	7,9	5,7	4,3	3,5
10 -	<b>14</b>	21,3	11,7	7,4	5,1	3,7	3,0
13 -	<b>18</b>	21,2	12,1	8,0	6,2	4,6	4,1
17 -	<b>24</b>	20,4	12,0	8,6	6,3	4,5	3,7
23 -	<b>32</b>	20,2	10,2	6,7	4,7	3,4	2,8

A	A	$I_A/I_N$ 3	$I_A/I_N$ 4	$I_A/I_N$ 5	$I_A/I_N$ 6	$I_A/I_N$ 7,2	$I_A/I_N$ 8
<b>U3/42</b>							
10 -	<b>14</b>	21,8	11,4	7,0	5,0	3,7	2,8
14 -	<b>20</b>	22,4	11,2	6,7	4,5	3,2	2,4
20 -	<b>28</b>	21,8	10,8	6,5	4,5	3,3	2,5
28 -	<b>42</b>	25,2	13,3	8,0	5,5	4,0	3,1

A	A	$I_A/I_N$ 3	$I_A/I_N$ 4	$I_A/I_N$ 5	$I_A/I_N$ 6	$I_A/I_N$ 7,2	$I_A/I_N$ 8
<b>U3/74</b>							
20 -	<b>28</b>	21,8	10,8	6,5	4,5	3,3	2,5
28 -	<b>42</b>	25,2	13,3	8,0	5,5	4,0	3,1
40 -	<b>52</b>	18,3	9,2	5,6	3,9	2,8	2,2
52 -	<b>65</b>	17,8	8,7	5,2	3,4	2,5	1,9

A	A	$I_A/I_N$ 3	$I_A/I_N$ 4	$I_A/I_N$ 5	$I_A/I_N$ 6	$I_A/I_N$ 7,2	$I_A/I_N$ 8
<b>U85 ..</b>							
60 -	<b>90</b>	19,5	13,5	11,0	10,0	9,5	8,5
80 -	<b>120</b>	18,0	11,0	10,0	9,0	8,5	8,0

A	A	$I_A/I_N$ 3	$I_A/I_N$ 4	$I_A/I_N$ 5	$I_A/I_N$ 6	$I_A/I_N$ 7,2	$I_A/I_N$ 8
<b>U840 ..</b>							
260 -	<b>360</b>	23,3	14,1	10,0	7,6	6,1	5,4
340 -	<b>480</b>	23,0	13,8	9,6	7,6	6,1	5,4
440 -	<b>620</b>	20,5	12,4	9,0	7,0	5,5	5,0
560 -	<b>800</b>	21,0	12,5	9,0	7,0	5,6	5,2

A	A	$I_A/I_N$ 3	$I_A/I_N$ 4	$I_A/I_N$ 5	$I_A/I_N$ 6	$I_A/I_N$ 7,2	$I_A/I_N$ 8
<b>U12/16E(A) ..</b>							
0,12 -	<b>0,18</b>	18,5	10,4	7,2	5,5	4,3	3,6
0,18 -	<b>0,27</b>	16,7	9,8	6,5	5,0	4,1	3,5
0,27 -	<b>0,4</b>	19,4	12,1	8,2	5,9	4,9	4,2
0,4 -	<b>0,6</b>	18,7	11,2	8,0	6,0	4,9	4,1
0,6 -	<b>0,9</b>	19,7	11,6	8,1	6,1	4,9	4,2
0,8 -	<b>1,2</b>	22,9	13,6	10,0	7,3	6,0	5,2
1,2 -	<b>1,8</b>	22,2	13,2	9,2	7,6	5,8	5,3
1,8 -	<b>2,7</b>	23,0	13,7	9,3	7,6	5,7	5,1
2,7 -	<b>4</b>	24,0	14,4	9,9	7,8	5,9	5,1
4 -	<b>6</b>	24,7	13,8	9,9	7,3	5,6	4,8
6 -	<b>9</b>	22,0	13,4	8	5,7	4,1	3,5
8 -	<b>11</b>	17,4	9,2	5,9	4,1	2,9	2,3
10 -	<b>14</b>	26,4	12,9	7,6	5,2	3,5	2,8
13 -	<b>18</b>	14,7	7,7	4,8	3,2	2,3	1,7
17 -	<b>23</b>	16,2	8,4	5,0	3,6	2,4	1,8
22 -	<b>30</b>	16,8	8,5	5,0	3,6	2,3	1,9

## Relays With Quick Tripping Characteristic

preferably for motors with short  $t_E$  time and for submersible pumps

**Setting Range** Tripping time depending on the multiple of the current setting from cold condition (tolerance  $\pm 20\%$  of the tripping time)

A	A	$I_A/I_N$ 3	$I_A/I_N$ 4	$I_A/I_N$ 5	$I_A/I_N$ 6	$I_A/I_N$ 7,2	$I_A/I_N$ 8
<b>U12/16EQ ..</b>							
0,4 -	<b>0,6</b>	13,6	8,4	5,9	4,2	3,3	3,0
0,6 -	<b>0,9</b>	13,8	7,8	5,2	4,1	3,2	2,7
0,8 -	<b>1,2</b>	13,1	7,5	5,2	3,9	3,1	2,7
1,2 -	<b>1,8</b>	14,6	8,7	6,0	4,6	3,6	3,2
1,8 -	<b>2,7</b>	13,5	7,6	5,3	3,9	3,1	2,7
2,7 -	<b>4</b>	11,0	6,0	4,1	2,6	1,7	1,4
4 -	<b>6</b>	9,6	5,3	3,3	2,3	1,6	1,3
6 -	<b>9</b>	10,2	5,4	3,4	2,3	1,6	1,3
8 -	<b>11</b>	12,0	6,2	3,9	2,5	1,8	1,3
10 -	<b>14</b>	12,8	6,6	4,0	2,6	1,8	1,4

All tripping times of overload relays U12/16EQ are shorter than the minimum values of the  $t_E$  time for motors of protection degree EEx e acc. to EN 50019 and therefore are suitable for all motors of protection degree EEx e. For these overload relays the selection on basis of tripping curves is thereby not necessary.

When selecting a standard overload, refer to the tripping curve. Determine the values of the starting current ratio  $I_A/I_N$  and the time  $t_E$  which is marked on the label of the motor. The overload must trip within the  $t_E$  time, which means that the tripping curve from cold condition must be (20% due to tolerance) below the co-ordination point  $I_A/I_N$  and the time  $t_E$ .

$I_A$  = Starting current of motor       $I_N$  = Rated current of motor  
 $t_E$  =  $t_E$ -time of motor

Time  $t_E$ /Tripping time

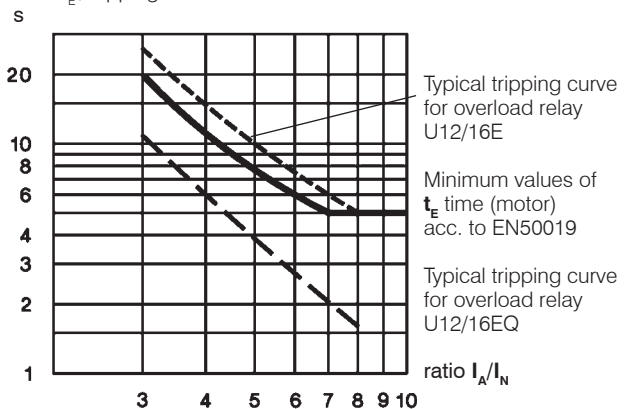

Labels of tripping curves for each setting range, sized 148x105mm (self-adhesive) are available on request.

Order No. D588, specify type and setting range.

### Example of selection for thermal overload relay:

Technical data of a motor protection EEx e  
 $P_N = 1,5kW$     $I_N = 3,6A$     $I_A/I_N = 5$     $t_E$  time = 8s

1) U12/16E 4 (2,7 - 4A)  
 Tripping time at  $5 \times I_N = 9,9s$   
 $9,9s + 20\% \text{ tolerance} = 11,9s > t_{E, \text{Motor}} = 8s$   
 The device U12/16E 4 is **not suitable**.

2) U12/16EQ 4 (2,7 - 4A)  
 Tripping time at  $5 \times I_N = 4,1s$   
 $4,1s + 20\% \text{ tolerance} = 4,9s < t_{E, \text{Motor}} = 8s$   
**The device U12/16EQ 4 is therefore suitable for motor protection**

# Thermal Overload Relays

## Fuses for U3/32, U3/42, U3/74, U12/16E, U85, U180, U320 and U800

Type	Setting Range		Max. Fuse Size According to Coordination-type				Fuse UL	SCCR
	DOL	YΔ	"2" <sup>1)</sup>		"1" <sup>1)</sup>			
			quick A	slow, gL(gG) A	slow, gL(gG) A	aM A		
U3/32 (U12/16E)	0,12 - <b>0,18</b>	-	0,5 <sup>2)</sup>	0,5 <sup>2)</sup>	25	-	15	5
	0,18 - <b>0,27</b>	-	1,0 <sup>2)</sup>	1,0 <sup>2)</sup>	25	-	15	5
	0,27 - <b>0,4</b>	-	2	2	25	-	15	5
	0,4 - <b>0,6</b>	-	2	2	25	-	15	5
	0,6 - <b>0,9</b>	-	4	4	25	-	15	5
	0,8 - <b>1,2</b>	-	4	4	25	2	15	5
	1,2 - <b>1,8</b>	-	6	6	25	2	15	5
	1,8 - <b>2,7</b>	-	10	10	25	4	15	5
	2,7 - <b>4</b>	-	16	10	25	4	15	5
	4 - <b>6</b>	7 - 10,5	20	16	25	6	15	5
	6 - <b>9</b>	10,5 - 15,5	35	25	35	10	25	5
	8 - <b>11</b>	14 - 19	35	25	35	16	30	5
	10 - <b>14</b>	18 - 24	50	35	63	16	40	5
	13 - <b>18</b>	23 - 31	50	35	63	20	50	5
17 - <b>(23)24</b>	30 - (40)41	63	50	63	25	60	5	
(22)23 - <b>(30)32</b>	(38)40 - (52)55	80	63	80	35	70	5	
U3/42	10 - <b>14</b>	18 - 24	50	35	80	16	40	5
	14 - <b>20</b>	24 - 35	63	50	80	25	60	5
	20 - <b>28</b>	35 - 48	80	63	80	35	80	5
	28 - <b>42</b>	48 - 73	100	80	150	50	110	5
U3/74	20 - <b>28</b>	35 - 48	100	80	150	35	80	5
	28 - <b>42</b>	48 - 73	125	100	150	50	110	5
	40 - <b>52</b>	70 - 90	160	100	150	63	200	5
	52 - <b>65</b>	90 - 112	160	125	150	80	250	10
	60 - <b>74</b>	104 - 128	160	125	150	80	250	10
U85	60 - <b>90</b>	104 - 156					300	10
	80 - <b>120</b>	140 - 207					-	10
U180, U320 U800	all ranges all ranges						-	-

For short circuit protecting overload relays with current transformer use fuse according to the contactor of the combination.

### Tripping Characteristics for U3/32, U3/42, U3/74 and U12/16E

Detailed tripping times for each range see table page 124

#### with three-phase load

Tripping time min. s (Average value of typical tolerance curves from cold condition)

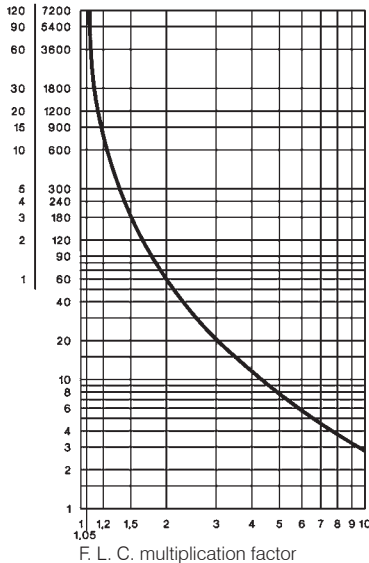

#### with two-pole load

Tripping time min. s (Typical tolerance curve from cold condition)

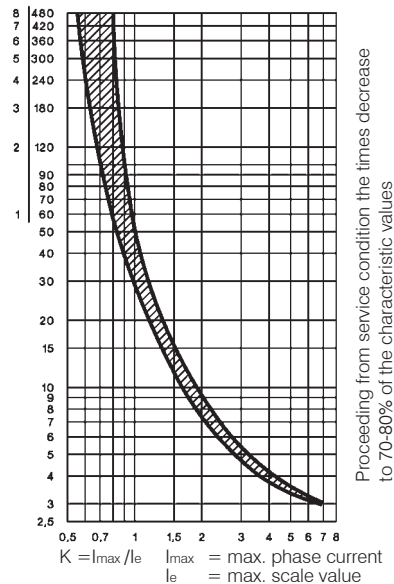

1) Coordination-type according to IEC 947-4-1:  
 "2": Light contact welding accepted. Thermal overload relay must not be damaged.  
 "1": Welding of contactor and damage of the thermal overload relay allowed.  
 2) Miniature fuse

3) Suitable for use on a capability of delivering not more than

# Thermal Overload Relays

## Tripping Characteristics for U85, U180, U320, and U800

Detailed tripping times for each range of U85 see table page 124

### U85 with three-phase load

Tripping time (Average value of typical tolerance curves from cold condition)

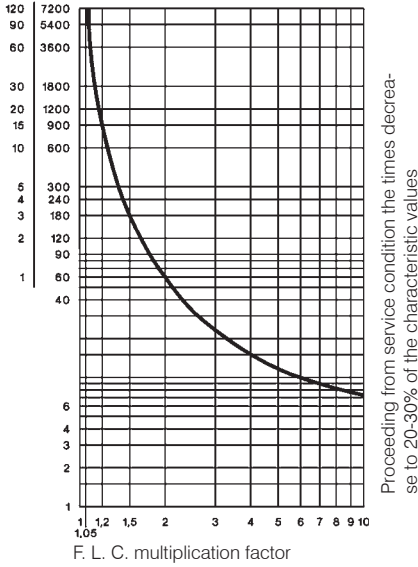

### U180, U320 with three-phase load

Tripping time (Average value of typical tolerance curves from cold condition)

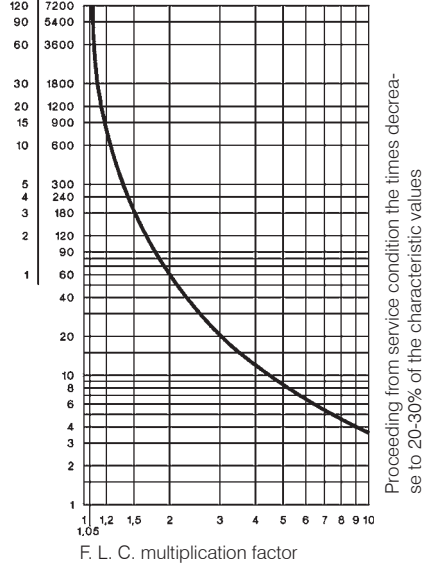

### U800 with three-phase load

Tripping time (Average value of typical tolerance curves from cold condition)

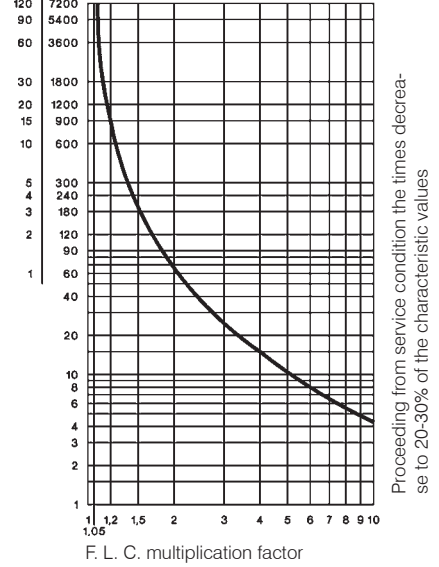

### U85 with two-pole load

Tripping time (Typical tolerance curve from cold condition)

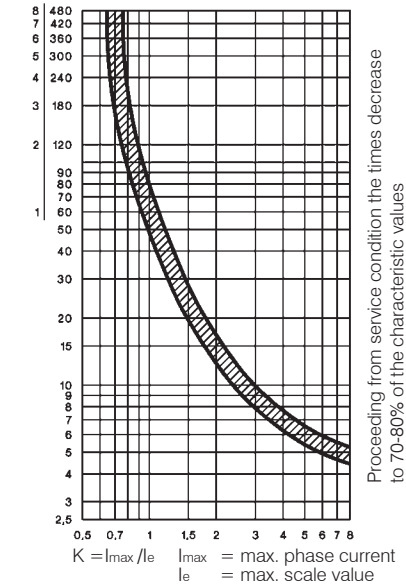

## Position of Terminals

### U3/32

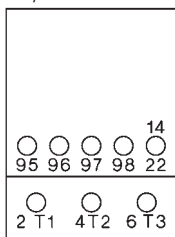

### U12/16E, U12/16EM, U12/16EQ

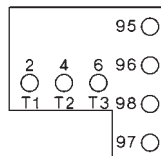

### U12/16A

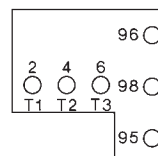

### U3/42, U3/74

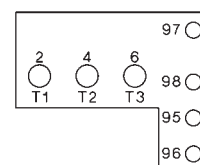

# Thermal Overload Relays in Special Version

## Fuse for U12/16EQ

Setting Range	Maximum Fuse Acc. to Coordination-type		
	"2" <sup>1)</sup> quick A	slow, gL(gG) A	"1" <sup>1)</sup> slow, gL(gG) A
0,4 - <b>0,6</b>	2	2	25
0,6 - <b>0,9</b>	4	4	25
0,8 - <b>1,2</b>	4	4	25
1,2 - <b>1,8</b>	6	6	25
1,8 - <b>2,7</b>	10	10	25
2,7 - <b>4</b>	16	10	25
4 - <b>6</b>	20	16	25
6 - <b>9</b>	35	25	35
8 - <b>11</b>	35	25	35
10 - <b>14</b>	50	35	63

## Fuse for U12/16EM

Setting Range	Maximum Fuse Acc. to Coordination-type "2" <sup>1)</sup>		
	380-400V slow, gL(gG) A	500V slow, gL(gG) A	660-690V slow, gL(gG) A
0,12 - <b>0,18</b>	none	none	on request
0,18 - <b>0,27</b>	none	none	on request
0,27 - <b>0,4</b>	none	none	on request
0,4 - <b>0,6</b>	none	none	on request
0,6 - <b>0,9</b>	none	none	on request
0,8 - <b>1,2</b>	none	10	on request
1,2 - <b>1,8</b>	none	16	on request
1,8 - <b>2,7</b>	20	20	on request
2,7 - <b>4</b>	35	35	on request

## Tripping Characteristic for U12/16EQ

Detailed tripping times for each range see table page 124

### with three-phase load

range 0,4-0,6 to 1,8-2,7A

Tripping time (Typical tolerance curve from cold condition)

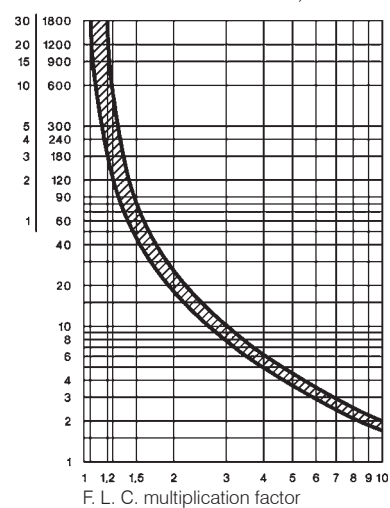

range 2,7-4 to 10-14A

Tripping time (Typical tolerance curve from cold condition)

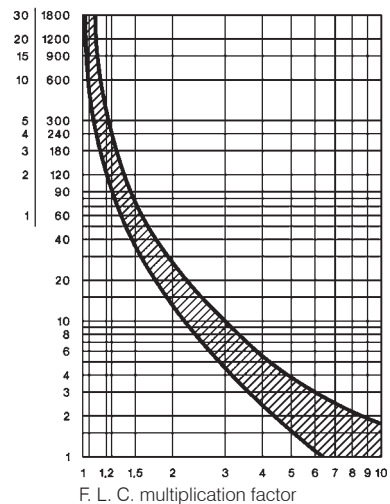

## Tripping Characteristic for U12/16EM

### with three-phase load

Tripping time (Average value of typical tolerance curves from cold condition)

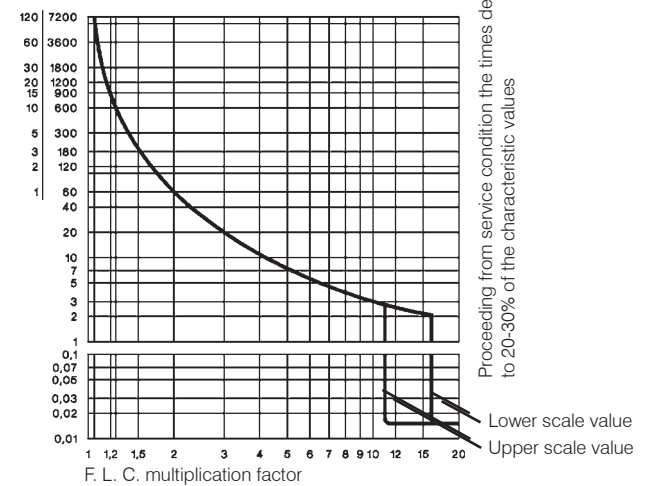

## Fuse for UAT21, UAT22, UAT23

For short circuit protecting thermal overload relays with current transformer use fuse according to the contactor of the combination.

## Tripping characteristic for UAT21, UAT22, UAT23

### with three-phase load

Tripping time in s (Typical tolerance curve from cold condition)

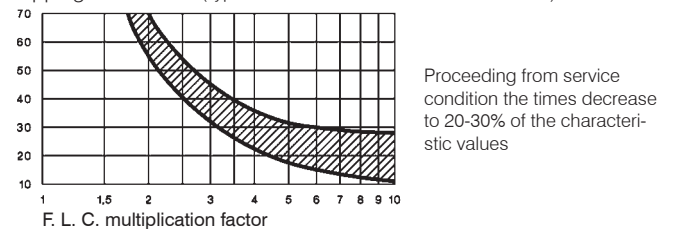

1) Coordination-type according to IEC 947-4-1:  
 "2": Light contact welding accepted. Thermal overload relay must not be damaged.  
 "1": Welding of contactor and damage of the thermal overload relay allowed.

# Thermal Overload Relays

Data according to IEC 947-4-1, IEC 947-5-1, VDE 0660, EN 60947-4-1, EN 60947-5-1

Type	U3/32	U12/16 <sup>6)</sup>	U3/42	U3/74	U85	U180	U320	U800	UAT21	UAT22	UAT23		
<b>Rated insulation voltage</b> $U_i^{1)}$	V~	690	690	690	690	750	1000	1000	1000	690	690	690	
<b>Permissible ambient temperature</b>													
operation	open			-25 to +60					-25 to +55			-25 to +60	
storage				-50 to +70					-40 to +70			-50 to +70	
<b>Trip class according to IEC 947-4-1</b>	10A	10A	10A	10A	20	10A	10A	10	30	30	30		
<b>Cable cross-section</b>													
main connector	solid or stranded	mm <sup>2</sup>	0,75-6	0,75-6+0,75-2,5 <sup>2)</sup>	0,75-10	4-35 <sup>2)</sup>	3)	7)	-	7)	0,5-10	0,5-16	0,5-25
	flexible	mm <sup>2</sup>	1-4	0,75-4+0,5-2,5 <sup>2)</sup>	0,75-6	6-25 <sup>2)</sup>					0,5-6	0,5-10	0,5-16
	flexible with multicore cable end	mm <sup>2</sup>	0,75-4	0,5-2,5+0,5-1,5	0,75-6	4-25					0,5-6	0,5-10	0,5-16
Cables per clamp	number		2	1+1	2	1					1	1	1
auxiliary connector	solid	mm <sup>2</sup>			0,75-2,5 <sup>2)</sup>				1-2,5 <sup>2)</sup>				0,75-2,5 <sup>2)</sup>
	flexible	mm <sup>2</sup>			0,5-2,5 <sup>2)</sup>				1-2,5 <sup>2)</sup>				0,5-2,5 <sup>2)</sup>
	flexible with multicore cable end	mm <sup>2</sup>			0,5-1,5				1-2,5 <sup>2)</sup>				0,5-1,5
Cables per clamp	number				2				2				2

Type	U3/32	U12/16A	U12/16E	U12/16EQ	U3/42	U85	U180	U800	UAT21	UAT22	UAT23
<b>Auxiliary contacts</b>											
<b>Rated insulation voltage</b> $U_i^{1)}$											
same potential	V~	690	690	690	690	690	690	500	690		
different potential	V~	440	-	440	440	250	440	440	500	440	
<b>Utilization category AC15</b>											
Rated operational current $I_e$	24V A	3	4	5	5	4	5	3	4 <sup>5)</sup>	5	
	230V A	2	2,5	3	3	2,5	3	2	2,5	3	
	400V A	1	1,5	2	2	1,5	2	1	1,5	2	
	690V A	0,5	0,6	0,6	0,6	0,6	0,6	0,5	0,6	0,6	
<b>Utilization category DC13</b>											
Rated operational current $I_e$	24V A	1	1,2	1,2	1,2	1,2	1,2	1	1,2	1,2	
	110V A	0,15	0,15	0,15	0,15	0,15	0,15	0,15	0,15	0,15	
	220V A	0,1	0,1	0,1	0,1	0,1	0,1	0,1	0,1	0,1	
<b>Short circuit prot.</b> (without welding 1kA)											
highest fuse rating	gL (gG) A	4	4	6	6	6	6	4	6	6	

Type	U3/32	U12/16	U12/16E	U3/42	U3/42	U3/74	U3/74	U85
Setting range	all	to 23A	22 - 30A	to 28A	28 - 42A	to 52A	52 - 65A	all
<b>Power loss per current path (max.)</b>								
minimum setting value	W	1,1	1,1	1,7	1,3	1,3	2,0	1,1
maximum setting value	W	2,3	2,3	3,7	2,6	3,3	3,7	2,5

## Data according to cULus

Type	U3/32	U12/16A	U12/16E	U12/16EQ	U3/42	U3/74	U85
<b>Rated insulation voltage</b>	V~	600	600	600	600	600	600
<b>Rated current</b>	A	32	23	23	23	42	85
<b>Auxiliary contacts</b>							
Rated voltage							
same potential	V~	600	600	600	600	600	600
different potential	V~	150	-	150	150	150	150
<b>Switching capacity AC</b>	VA	500	500	500	500	600	600
of aux. contacts	A	2	3	4	4	4	4

## Temperature Compensation

In case of higher ambient temperature use the following formula:  
**(Ambient temperature - 20) x 0,125 = correction factor in % of the full load motor current**

**Example: Ambient temperature 70°C, full load motor current 7A**  
**(70 - 20) x 0,125 = 6,25%**  
**Setting value: 7A + 6,25% = 7,44A**

1) Suitable for: earthed-neutral systems, overvoltage category I to III, pollution degree 3 (standard-industry):  $U_{imp} = 4kV$  (at 440V), 6kV (at 690V).

Data for other conditions on request.

2) Maximum cable cross-section with prepared conductor

3) Without terminals, suitable for bushing one connector 70mm<sup>2</sup> (stranded) per phase

4) Switching capacity of the start contact: AC15 300VA, max. 1,5A, DC13 (max. 220V) 30W, max. 1,5A

5) Switching capacity of the make contact: AC15 400VA, max. 1,7A, DC13 (max. 220V) 10W, max. 1A

6) U12/16E 30: Cable cross-section for main connector like type U3/42, one connector only

7) Busbar sets see accessories page 123

# Thermal Overload Relays

## Dimensions

K3-10N + U3/32

K3-14N

K3-18N

K3-22N

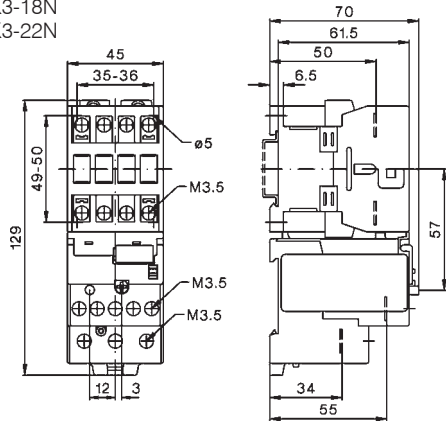

KG3-10 + U3/32

KG3-14

KG3-18

KG3-22

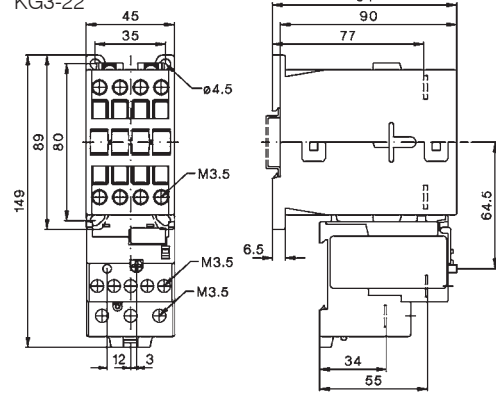

K3-24 + U3/32

K3-32

K3-40

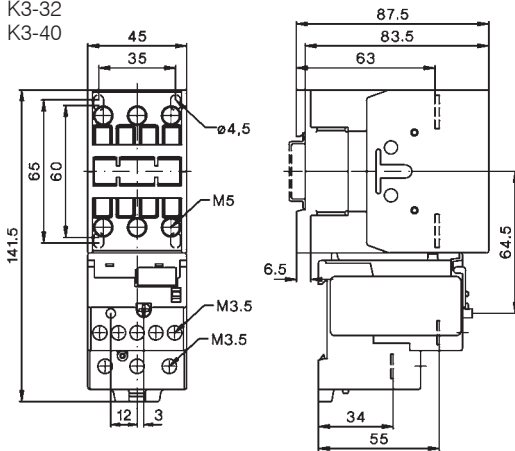

KG3-24 + U3/32

KG3-32

KG3-40

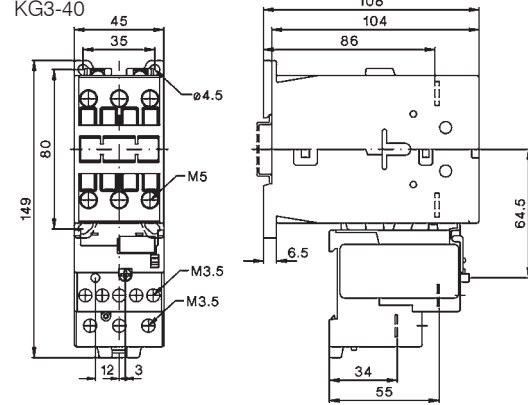

K3-24 + U3/42

K3-32

K3-40

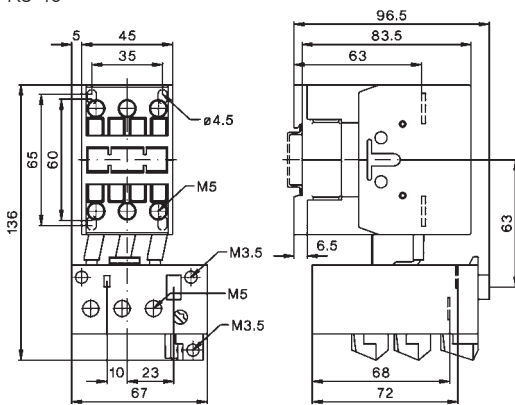

KG3-24 + U3/42

KG3-32

KG3-40

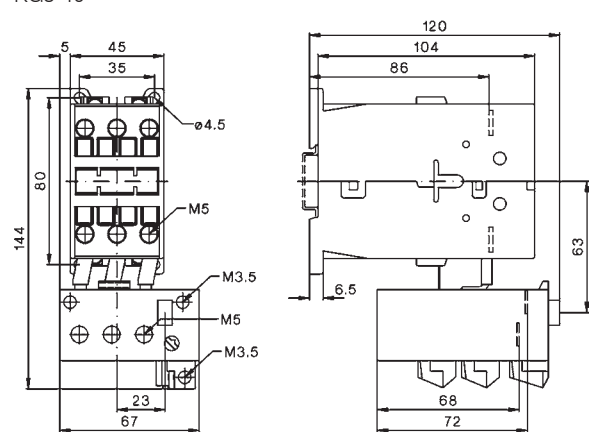

U3/32SM

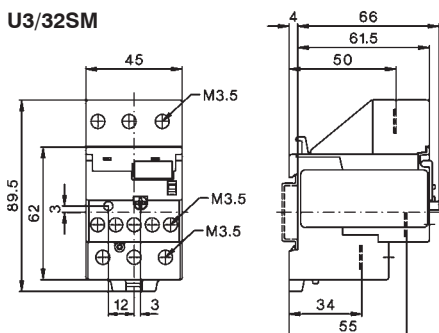

U3/42G + LG5830-

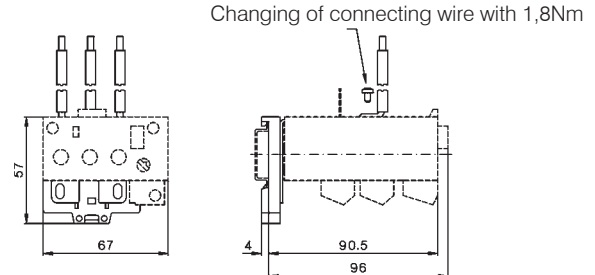



# Thermal Overload Relays

## Dimensions

K1-09 + U12/16..K1  
K1-12

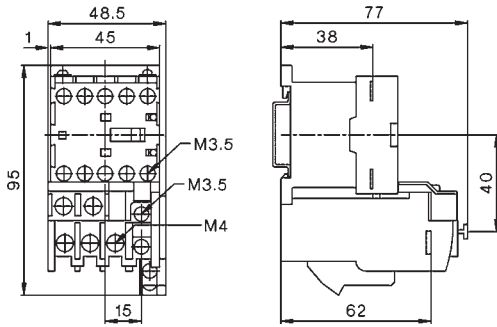

K3-10 + U12/16..K3  
K3-14  
K3-18  
K3-22

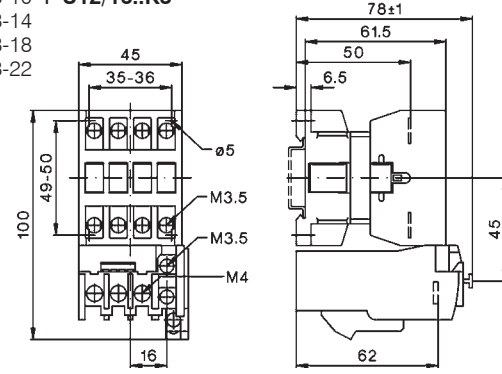

K3-10N + U12/16..K3  
K3-14N  
K3-18N  
K3-22N

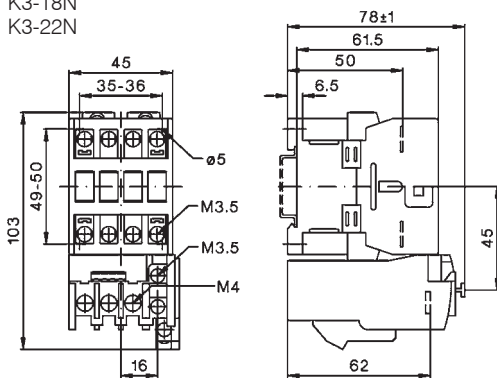

KG3-10 + U12/16..K3  
KG3-14  
KG3-18  
KG3-22

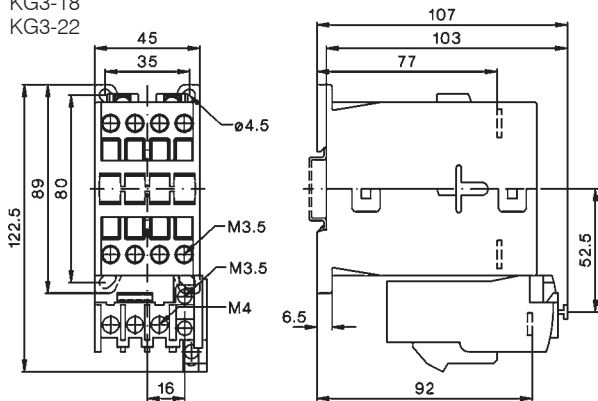

## U12SM K3

U12/16..K3 + U12SM K3 for snap-on 35mm DIN-rail according to DIN EN50022 and screw mounting (single mounting)

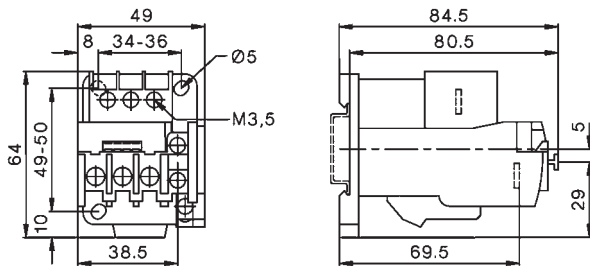

K3-50 + U3/74  
K3-62  
K3-74

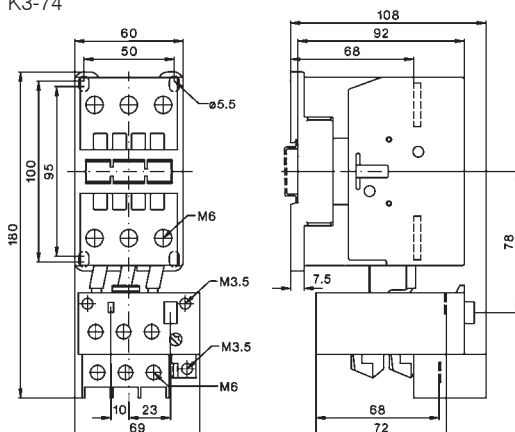

# Thermal Overload Relays

## Dimensions

K3-90A + U85  
K3-115A

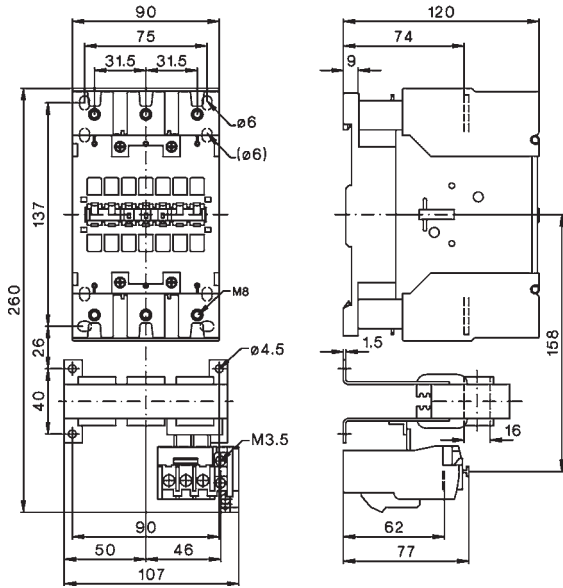

K3-151A00 + U180  
K3-176A00

Mounting holes

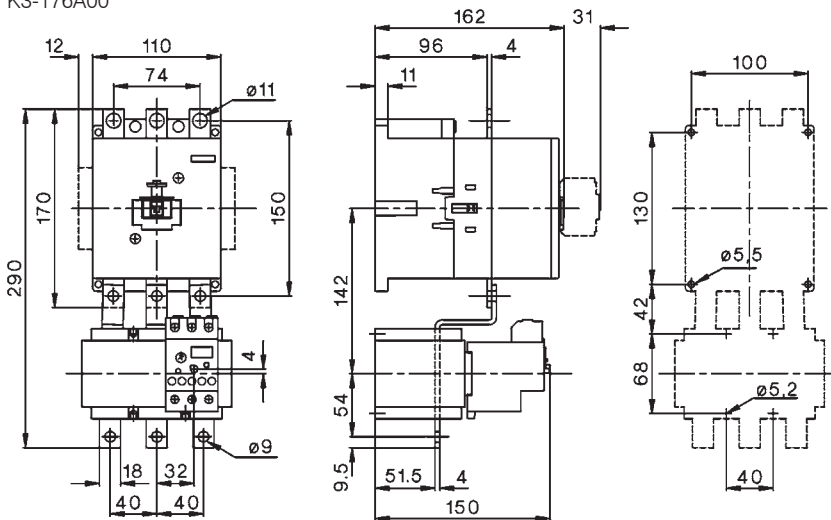

K3-210A00 + U320  
K3-260A00  
K3-316A00

Mounting holes

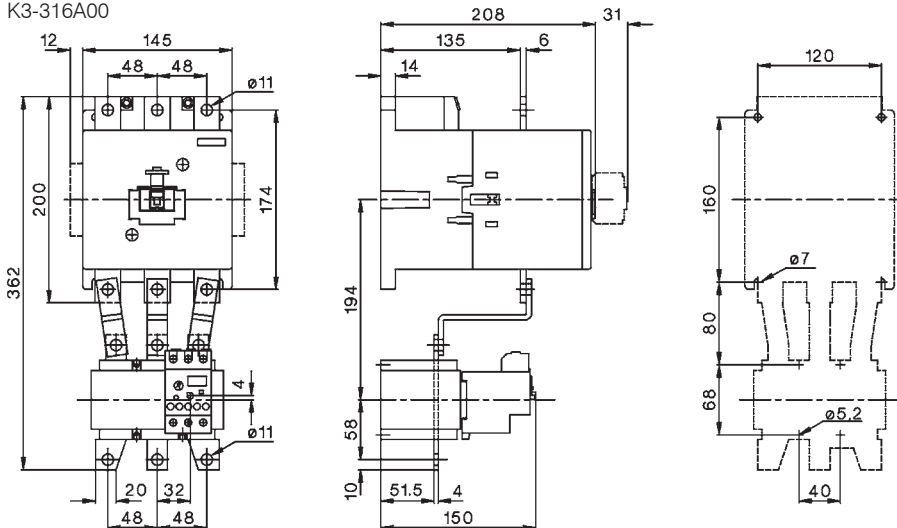

# Thermal Overload Relays

## Dimensions

### U800

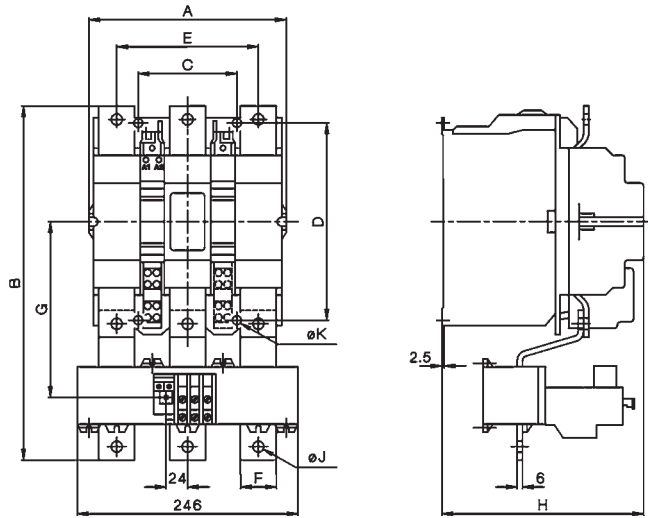
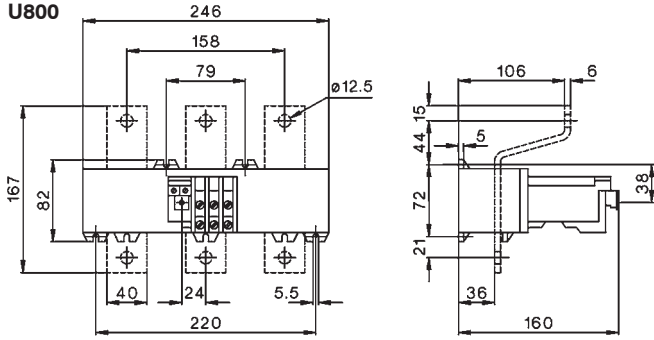

U800 with	A	B	C	D	E	F	G	H	J	K
<b>K3-450</b>	220	372	110	220	158	40	185	225	12,5	9
<b>K3-550</b>	220	395	110	220	158	40	196	225	12,5	9
<b>K3-700</b>	280	487	175	280	202	50	257	291	14,5	11
<b>K3-860</b>	280	540	175	280	202	50	280	291	14,5	11

### UAT21

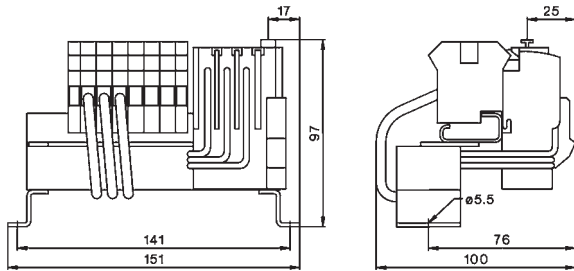



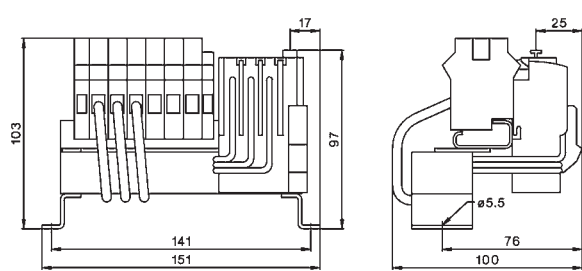

### UAT22

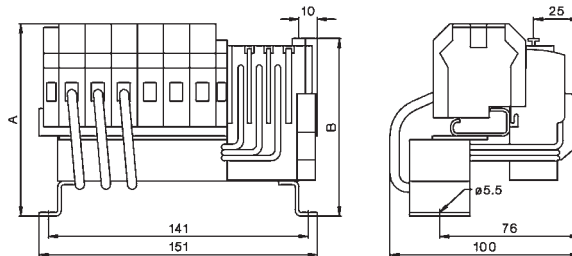

### UAT23

Type	Setting Range	A	B
<b>UAT23 37</b>	23-37A	105,5	97,5
<b>UAT23 49</b>	32-49A	94	86
<b>UAT23 72</b>	48-72A	94	86



	<p>Modular Contactors</p>	<p>134</p>
	<p>Auxiliary Contact Block Accessories</p>	<p>135 135</p>
	<p>Switching Of Lamps</p>	<p>136</p>
	<p>Technical Data</p>	<p>138</p>
	<p>Dimensions</p>	<p>140</p>

# Modular Contactors

Rated Current	Heating Power AC1 at		Type	coil voltage	Pack pcs.	Weight kg/pc.	Wiring Diagram
	1-phase	3-phase					
400V A	230V kW	400V kW	24	24V 50/60Hz	12	0,12	
			230	220-240V 50Hz, 230-264V 60Hz			
			24VM	24V 50/60Hz, 24V DC			
			230VM	220-240V 50/60Hz, 220V DC			

## One-pole 1 module (17,5mm), AC-operated (low noise)



20	4,6	-	R20-10 24	12	0,12
20	4,6	-	R20-10 230	12	0,12



## Two-pole 1 module (17,5mm), AC-operated (low noise)



20	4,6	-	R20-20 24	12	0,12
20	4,6	-	R20-20 230	12	0,12

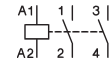

20	4,6	-	R20-11 24	12	0,12
20	4,6	-	R20-11 230	12	0,12

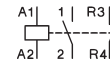

20	4,6	-	R20-02 24	12	0,12
20	4,6	-	R20-02 230	12	0,12

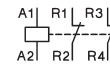

25	5,5	-	R25-20 24	12	0,14
25	5,5	-	R25-20 230	12	0,14

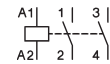

25	5,5	-	R25-11 24	12	0,14
25	5,5	-	R25-11 230	12	0,14

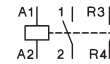

25	5,5	-	R25-02 24	12	0,14
25	5,5	-	R25-02 230	12	0,14

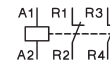

## Four-pole 2 modules (35mm) <sup>1)</sup>, AC-operated (low noise)



25	5,7	17	R25-40 24	6	0,21
25	5,7	17	R25-40 230	6	0,21

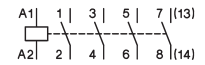

25	5,7	17	R25-31 24	6	0,21
25	5,7	17	R25-31 230	6	0,21

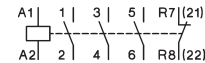

25	5,7	17	R25-13 24	6	0,21
25	5,7	17	R25-13 230	6	0,21

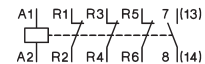

25	5,7	-	R25-22 24	6	0,21
25	5,7	-	R25-22 230	6	0,21

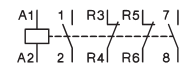

25	5,7	17	R25-04 24	6	0,21
25	5,7	17	R25-04 230	6	0,21

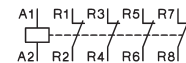

## Four-pole 2 modules(35mm), AC/DC-operated <sup>1)</sup>, (hum free)



25	5,7	17	R25-40 24VM	6	0,22
25	5,7	17	R25-40 230VM	6	0,22

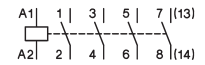

25	5,7	17	R25-31 24VM	6	0,22
25	5,7	17	R25-31 230VM	6	0,22

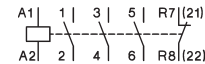

25	5,7	17	R25-13 24VM	6	0,22
25	5,7	17	R25-13 230VM	6	0,22

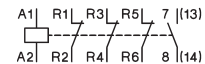

25	5,7	-	R25-22 24VM	6	0,22
25	5,7	-	R25-22 230VM	6	0,22

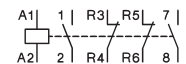

25	5,7	17	R25-04 24VM	6	0,22
25	5,7	17	R25-04 230VM	6	0,22

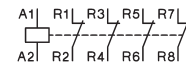

1) Sealable with Sealing Cover P721, available aux. contact block RH11(see page 135)  
 2) Sealable with Sealing Cover P721, available aux. contact block RH11-1(see page 135)

# Modular Contactors

Rated Current	Heating Power AC1 at	Type	coil voltage	Pack pcs.	Weight kg/pc.	Wiring Diagram
<b>400V</b>	1-phase 230V	<b>24</b>	24V 50/60Hz			
<b>A</b>	3-phase 400V	<b>230</b>	220-240V 50Hz, 230-264V 60Hz			



## Two-pole 2 modules (35mm), AC-operated (low noise)

<b>40</b>	9	-	<b>R40-20 24</b>	6	0,23	
<b>40</b>	9	-	<b>R40-20 230</b>	6	0,23	
<b>40</b>	9	-	<b>R40-02 24</b>	6	0,23	
<b>40</b>	9	-	<b>R40-02 230</b>	6	0,23	
<b>63</b>	14,3	-	<b>R63-20 24</b>	6	0,23	
<b>63</b>	14,3	-	<b>R63-20 230</b>	6	0,23	
<b>63</b>	14,3	-	<b>R63-02 24</b>	6	0,23	
<b>63</b>	14,3	-	<b>R63-02 230</b>	6	0,23	



## Four-pole 3 modules (52,5mm)<sup>1)</sup>, AC-operated (low noise)

<b>40</b>	9	27,5	<b>R40-40 24</b>	4	0,35	
<b>40</b>	9	27,5	<b>R40-40 230</b>	4	0,35	
<b>40</b>	9	27,5	<b>R40-31 24</b>	4	0,35	
<b>40</b>	9	27,5	<b>R40-31 230</b>	4	0,35	
<b>40</b>	9	-	<b>R40-22 24</b>	4	0,35	
<b>40</b>	9	-	<b>R40-22 230</b>	4	0,35	
<b>40</b>	9	27,5	<b>R40-04 24</b>	4	0,35	
<b>40</b>	9	27,5	<b>R40-04 230</b>	4	0,35	
<b>63</b>	14,3	43	<b>R63-40 24</b>	4	0,36	
<b>63</b>	14,3	43	<b>R63-40 230</b>	4	0,36	
<b>63</b>	14,3	43	<b>R63-31 24</b>	4	0,36	
<b>63</b>	14,3	43	<b>R63-31 230</b>	4	0,36	
<b>63</b>	14,3	-	<b>R63-22 24</b>	4	0,36	
<b>63</b>	14,3	-	<b>R63-22 230</b>	4	0,36	
<b>63</b>	14,3	43	<b>R63-04 24</b>	4	0,36	
<b>63</b>	14,3	43	<b>R63-04 230</b>	4	0,36	



## Auxiliary Contact Block 1/2 module (8,8mm) for contactor R25, R40, R63 (4p.) max. 1 piece for contactor R40 and R63 (2p.) max. 1 piece



Rated current	Type	Pack pcs.	Weight kg/pc.	Wiring Diagram
<b>AC15</b> AC15 AC1	for contactor			
<b>230V</b> 400V 400V				
<b>A</b> A A				
<b>3</b> 2 10	R25 <sup>2)</sup> , R40, R63	<b>RH11</b>	3	0,026
<b>3</b> 2 10	R25-..VM	<b>RH11-1</b>	3	0,026

## Accessories



<b>RC-unit</b> 2x for R20.. to R63.. for 12V to 250V AC 220nF / 100 Ohm not for R25-..VM	<b>RC-R 230</b>	2	0,05
--	-----------------	---	------



<b>Spacing piece</b> 1/2 module (8,8mm) for R20.. to R63.. for ambient temperature >40°C	<b>P730</b>	10	0,012
--	-------------	----	-------



<b>Sealing cover</b> for R25.. (4p.)	<b>P721</b>	10	0,002
<b>Sealing cover</b> for R40.., R63..	<b>P690</b>	10	0,003

1) Sealable with Sealing Cover P690, available aux. contact block RH11  
 2) AC-operated R25-..., 4-pole

## Modular Contactors

### Switching of lamps

Lamp Type	Power W	Current A	Capacitors µF	Max. lamps per pole at 230V 50Hz and max. 60°C			
				R20..	R25..	R40..	R63..
<b>Incandescent lamps</b>	60	0,27	-	36	50	92	129
	100	0,45	-	21	30	55	77
	200	0,91	-	10	15	27	38
	300	1,36	-	7	10	19	26
	500	2,27	-	4	6	11	16
	1000	4,5	-	2	3	6	8
<b>Fluorescent lamps</b> uncompensated or serial compensated	11	0,16	1,3	60	75	210	310
	18	0,37	2,7	25	30	90	140
	24	0,35	2,5	25	30	90	140
	36	0,43	3,4	20	25	70	140
	58	0,67	5,3	14	17	45	70
	65	0,67	5,3	13	16	40	65
	85	0,8	5,3	11	14	35	60
	<b>Fluorescent lamps</b> dual-connection	11	0,07	-	2 x 100	2 x 110	2 x 220
18	0,11	-	2 x 50	2 x 55	2 x 130	2 x 200	
24	0,14	-	2 x 40	2 x 44	2 x 110	2 x 160	
36	0,22	-	2 x 30	2 x 33	2 x 70	2 x 100	
58	0,35	-	2 x 20	2 x 22	2 x 45	2 x 70	
65	0,35	-	2 x 15	2 x 16	2 x 40	2 x 60	
85	0,47	-	2 x 10	2 x 11	2 x 30	2 x 40	
<b>Fluorescent lamps</b> parallel compensated	11	0,09	2	33	43	67	107
	18	0,13	2	25	32	50	80
	24	0,16	3	25	32	50	80
	36	0,27	4	22	32	50	80
	58	0,45	7	14	18	36	46
	65	0,5	7	14	18	36	46
	85	0,6	8	12	16	33	44
	<b>Fluorescent lamps</b> with electronic fluorescent lamp ballast	18	0,09	-	40	40	100
36		0,16	-	20	20	52	75
58		0,25	-	15	15	30	55
80		0,4	-	7	10	20	30
2 x 18		0,17	-	20	20	50	60
2 x 28		0,25	-	15	15	37	45
2 x 36		0,32	-	10	10	25	30
2 x 58		0,49	-	7	7	15	20
2 x 80		0,7	-	4	4	8	10
<b>Transformers</b> for metal halid low voltage lamps		20	0,09	-	40	52	110
	50	0,22	-	20	24	50	80
	75	0,33	-	13	16	35	54
	100	0,43	-	10	12	27	43
	150	0,65	-	7	9	19	29
	200	0,87	-	5	5	14	23
	300	1,3	-	3	4	9	14
<b>Mercury-vapour lamps</b> (high-pressure lamps), uncompensated e. g. HQL, HPL	50	0,61	-	16	21	38	55
	80	0,8	-	12	16	29	40
	125	1,15	-	8	11	20	28
	250	2,15	-	4	6	11	15
	400	3,25	-	3	4	7	10
	700	5,4	-	1	2	4	6
	1000	7,5	-	1	1	3	4
<b>Mercury-vapour lamps</b> (high-pressure lamps), compensated e. g. HQL, HPL	50	0,28	7	14	18	36	50
	80	0,41	8	12	16	31	44
	125	0,65	10	10	13	25	35
	250	1,22	18	5	7	14	19
	400	1,95	25	4	5	10	14
	700	3,45	45	2	3	6	8
	1000	4,8	60	1	2	4	6

# Modular Contactors

## Switching of lamps

Lamp Type	Power W	Current A	Capacitors μF	Max. lamps per pole at 230V 50Hz and max. 60°C				
				R20..	R25..	R40..	R63..	
<b>Metal halide lamps</b> uncompensated e. g. HQI, HPI, CDM	35	0,53	-	22	24	57	65	
	70	1	-	12	14	30	35	
	150	1,8	-	6	8	17	18	
	250	3	-	4	5	10	12	
	400	3,5	-	3	4	8	10	
	1000	9,5	-	1	1	3	4	
	2000	16,5	-	-	-	2	2	
	400V per pole	2000	10,5	-	-	2	2	
	3500	18	-	-	1	1		
	<b>Metal halide lamps</b> compensated e. g. HQI, HPI, CDM	35	0,25	6	16	21	42	58
70		0,45	12	8	11	21	29	
150		0,75	20	5	7	13	18	
250		1,5	33	3	4	9	11	
400		2,1	35	2	4	9	10	
1000		5,8	95	1	1	3	4	
2000		11,5	148	-	-	2	2	
400V per pole		2000	6,6	58	-	-	3	4
3500		11,6	100	-	-	2	3	
<b>Metal halide lamps</b> with electronic fluorescent with electronic fluorescent lamp ballast (e. g.: PCI) 50-125 x I <sub>nlamp</sub> for 0,6ms		20	0,1	integrated	9	9	18	20
	28	0,15	integrated	-	-	-	18	
	35	0,2	integrated	6	6	11	13	
	70	0,36	integrated	5	5	10	12	
	150	0,7	integrated	4	4	8	10	
<b>Sodium-vapour lamps</b> (low pressure lamps), uncompensated	35	1,5	-	7	9	22	30	
	55	1,5	-	7	9	22	30	
	90	2,4	-	4	6	13	19	
	135	3,3	-	3	4	10	14	
	150	3,3	-	3	4	10	14	
	180	3,3	-	3	4	10	14	
	200	3,3	-	3	4	10	14	
<b>Sodium-vapour lamps</b> (low pressure lamps), compensated	35	0,31	20	5	6	15	18	
	55	0,42	20	5	6	15	18	
	90	0,63	30	3	4	10	12	
	135	0,94	45	2	3	7	8	
	150	1	40	2	3	8	9	
	180	1,16	40	2	3	8	9	
200	1,32	25	-	-	10	12		
<b>Sodium-vapour lamps</b> (high pressure lamps), uncompensated	150	1,8	-	5	8	17	22	
	250	3	-	4	5	10	13	
	330	3,7	-	3	4	8	10	
	400	4,7	-	2	3	6	8	
	1000	10,3	-	1	1	3	4	
<b>Sodium-vapour lamps</b> (high pressure lamps), compensated	150	0,83	20	5	7	20	25	
	250	1,5	33	3	4	12	15	
	330	2	40	2	3	10	13	
	400	2,4	48	2	2	8	12	
1000	6,3	106	1	1	4	6		
<b>Sodium-vapour lamps</b> (high pressure lamps) with serial electronic (e. g.: PCI) 50-125 x I <sub>nlamp</sub> for 0,6ms	20	0,1	integrated	9	9	18	20	
	35	0,2	integrated	6	6	11	13	
	70	0,36	integrated	5	5	10	12	
	150	0,7	integrated	4	4	8	10	
<b>LED-Lamps</b> consider the inrush current of the lamp ballast and the cosφ of the lamp	max. inrush current of contactor [A]			195A	233A	424A	565A	
	inrush current of contactor inrush current of lamp/EVG			= max. lamps per pole at 230V 50Hz and max. 60°C (I <sub>nLED</sub> ≤ I <sub>tr</sub> )				



# Modular Contactors

Data according to IEC60 947-4-1, IEC 60947-5-1, VDE 0660-5-1

Type	2-pole				4-pole			RH11	
	R20 (VM) <sup>3)</sup>	R25 (VM) <sup>3)</sup>	R40	R63	R25 (VM) <sup>3)</sup>	R40	R63		
<b>Main Contacts</b> <sup>4) 5) 6)</sup>									
<b>Rated insulation voltage U<sub>i</sub><sup>1)</sup></b>	V~	<b>440</b>	<b>440</b>	<b>440</b>	<b>440</b>	<b>440</b>	<b>440</b>	<b>440</b>	
Rated operation voltage U <sub>e</sub>	V~	440	440	440	440	440	440	440	
<b>Frequency of operations z</b> AC1, AC3	1/h	300	300	600	600	300	600	600	
<b>Mechanical life</b>	S x 10 <sup>6</sup>	1	1	1	1	1	1	1	
<b>Utilization category AC1 / AC7a</b>									
<b>Switching of resistive load</b>									
Rated operational current I <sub>e</sub> (=I <sub>th</sub> ) open	A	20	25	40	63	25	40	63	-
<b>Contact life</b>	S x 10 <sup>6</sup>	0,1	0,1	0,1	0,1	0,1	0,1	0,1	-
<b>Minimum Switch Voltage</b>	V/mA	24/100	24/100	24/100	24/100	24/100	24/100	24/100	17/5
<b>Short time current</b> 10s-current	A	72	72	216	240	72	216	240	-
<b>Power loss</b> per pole at I <sub>e</sub> /AC1	W	2	3	3	7	2	3	7	0,5
<b>Utilization category AC2 and AC3 / AC7b</b>									
<b>Switching of three-phase motors</b>									
Rated operational current I <sub>e</sub>	A	-	-	-	-	9	27	30	-
Rated operational power of three-phase motors		-	-	-	-	2,2	7,5	8	-
50-60Hz	220V kW	-	-	-	-	2,5	8	8,5	-
	230-240V kW	-	-	-	-	4	12,5	15	-
	380-415V kW	-	-	-	-	-	-	-	-
2-pole motors	230V kW	1,1 <sup>2)</sup>	1,3	2,6	5	-	-	-	-
<b>Contact life</b>	S x 10 <sup>6</sup>	0,15	0,15	0,15	0,15	0,15	0,15	0,15	-
<b>Power consumption of coils</b>									
AC operated	inrush VA	7 - 9	7 - 9	-	-	20 - 25	33 - 45	33 - 45	-
	sealed VA	2,2 - 4,2	2,2 - 4,2	5 - 7	5 - 7	4 - 6	6 - 8	6 - 8	-
	W	0,8 - 1,6	0,8 - 1,6	-	-	1,5 - 2,5	2,6	2,6	-
AC and DC-operated	W	-	-	-	-	3 - 4	-	-	-
<b>Operation range of coils</b>									
in multiples of control voltage U <sub>c</sub> (-40° – +40°C)		0,85 - 1,1	0,85 - 1,1	0,85 - 1,1	0,85 - 1,1	0,85 - 1,1	0,85 - 1,1	0,85 - 1,1	-
<b>Noise level (operation)</b>									
<b>acc. to EN ISO 3744</b>									
from front, distance 0,5 m	dB	16 (0) <sup>3)</sup>	16 (0) <sup>3)</sup>	8	8	8 (0) <sup>3)</sup>	< 4	< 4	-

1) Suitable for: earthed-neutral systems, overvoltage category I to III, pollution degree 3 (standard-industry): U<sub>imp</sub> = 4kV.

2) AC7b motor 2-pole 230V 1,1kW

3) 0 dB for contactors type "VM" (AC/DC operated)

4) Rated frequency 50/60Hz

5) Max. occ. switching overvoltage <4kV

6) Duty cycle: 100%

# Modular Contactors

Data according to IEC60 947-4-1, IEC 60947-5-1, VDE 0660-5-1

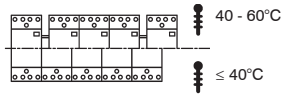
Type	R20	R25 (2p.)	R25 (4p.)	R25-..VM	R40 (2p./4p.)	R63 (2p./4p.)	RH11
<b>Maximum ambient temperature</b>							
Operation	open °C		-40 to + 60				
	enclosed °C		-40 to + 40				
Storage	°C		-50 to + 90				
<b>Short circuit protection</b>							
max. fuse Coordination-type "1"gL (gG)	A	35	35	35	63	80	-
Rated short circuit current	"I <sub>sc</sub> " kA	3	3	3	3	3	-
	"I <sub>q</sub> " kA	3	3	10	10	10	-
<b>Switching time</b> at control voltage U <sub>s</sub> ± 10%							
make time	ms	7 - 16	7 - 16	9 - 15	17 - 50	11 - 15	11 - 15
release time	ms	6 - 12	6 - 12	4 - 8	17 - 23	6 - 13	6 - 13
arc duration	ms	10 - 15	10 - 15	10 - 15	10 - 15	10 - 15	10 - 15
<b>Cable cross-sections</b>							
Main connector	solid or stranded mm <sup>2</sup>	1,5 - 10	1,5 - 10	1,5 - 10	1,5 - 10	2,5 - 25	2,5 - 25
	flexible mm <sup>2</sup>	1,5 - 6	1,5 - 6	1,5 - 6	1,5 - 6	2,5 - 16	2,5 - 16
	flexible with multicore cable end mm <sup>2</sup>	1,5 - 6	1,5 - 6	1,5 - 6	1,5 - 6	2,5 - 16	2,5 - 16
Clamps per pole		1	1	1	1	1	2
Magnetic coil	solid or stranded mm <sup>2</sup>	0,75 - 2,5	0,75 - 2,5	0,75 - 2,5	0,75 - 2,5	0,75 - 2,5	0,75 - 2,5
	flexible mm <sup>2</sup>	0,5 - 2,5	0,5 - 2,5	0,5 - 2,5	0,5 - 2,5	0,5 - 2,5	0,5 - 2,5
	flexible with multicore cable end mm <sup>2</sup>	0,5 - 1,5	0,5 - 2,5	0,5 - 1,5	0,5 - 1,5	0,5 - 1,5	0,5 - 1,5
Clamps per pole		1	1	1	1	1	-
<b>Auxiliary Contacts</b> <sup>4) 5) 6)</sup>							
Rated insulation voltage U <sub>i</sub> <sup>1)</sup>	V AC	-	-	440	440	440	440
Thermal rated current I <sub>th</sub>	40°C A	-	-	25	25	40	63
Ambient temperature	60°C A	-	-	25	25	40	63
<b>Utilization category AC15</b>							
Rated operational current I <sub>e</sub>	220-240V A	-	-	3	3	3	3
	380-415V A	-	-	2	2	2	2
	440V A	-	-	1,6	1,6	1,6	1,6
<b>Utilization category DC13</b>							
Rated operational current I <sub>e</sub>	24-60V A	-	-	2	2	2	2
	110V A	-	-	0,4	0,4	0,4	0,4
per pole	220V A	-	-	0,1	0,1	0,1	0,1
<b>Short circuit protection</b>							
short-circuit current 1kA, contact welding not accepted		-	-	10	10	10	10
max. fuse size	gL (gG) A	-	-	10	10	10	10

## Data according to UL508

Main Contacts (cULus)	Type	R20	R25 (2p.)	R25 (4p.)	R40 (2p./4p.)	R63 (2p./4p.)	RH11
Rated operational current "General Use"	A	20	25	25	40	63	10
Rated operational power of three-phase motors at 60Hz (3ph)	110-120V hp	-	-	1	2	3	-
	200-208V hp	-	-	2	5	7½	-
	220-240V hp	-	-	3	7½	10	-
	265-277V hp	-	-	3	7½	10	-
Rated operational power of AC motors at 60Hz (1ph)	110-120V hp	½	½	½	1	1½	-
	200-208V hp	1	1	1	2	3	-
	220-240V hp	1½	1 ½	1½	3	5	-
	265-277V hp	1½	2	2	3	5	-
Fuses	A	40	40	40	80	80	-
Suitable for use on a capability of delivering not more than	rms A	5000	5000	5000	5000	5000	-
	V	300	300	300	300	300	300
Rated operation voltage	V~	300	300	300	300	300	300
<b>Auxiliary Contacts (cULus)</b>	heavy pilot duty AC	-	-	-	-	-	C300

1) Suitable for: earthed-neutral systems, overvoltage category I to III, pollution degree 3 (standard-industry): U<sub>imp</sub> = 4kV.

3) Maximum cable cross-section with prepared conductor

4) Rated frequency 50/60Hz

5) Max. occ. switching overvoltage < 4kV

6) Duty cycle: 100%

# Maße

R20-..., R25-... (2-pole)  
RC-R 230

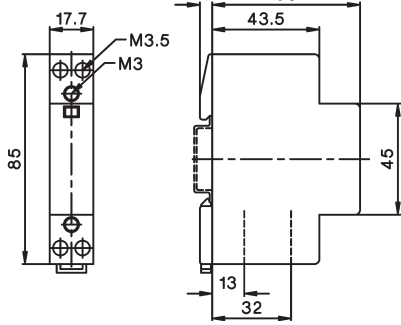

R25-... (4-pole) (+RH11)  
R25-...VM (+RH11-1)

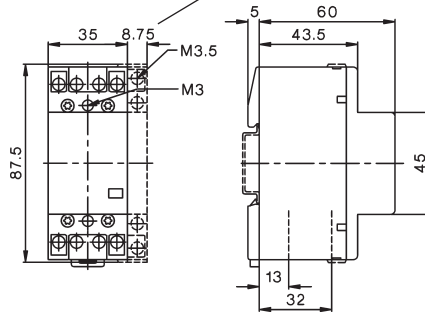

R40-... (2-pole)  
R63-... (2-pole)

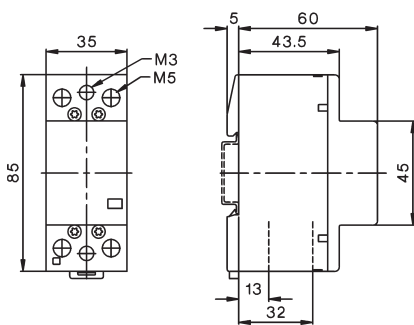

R40-... (4-pole) (+RH11)  
R63-... (4-pole) (+RH11)

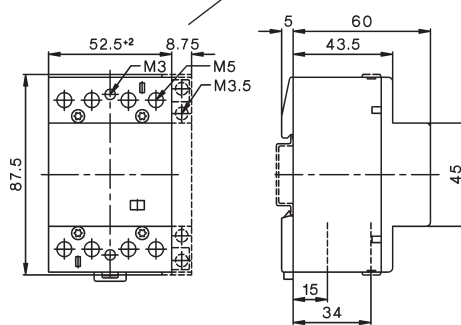

Aux. contact block  
RH11, RH11-1

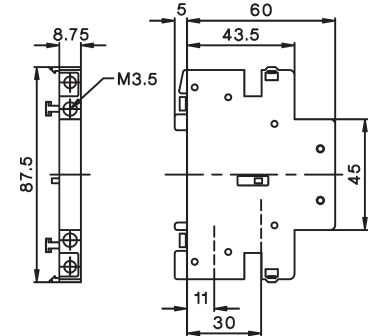

# Contactors for DC-Switching

AC-operated

## Rated Operational Current

DC1

Additional  
Aux.  
Contacts

Coil voltage <sup>1)</sup>  
**230**  
220-230V 50Hz, 240V 60Hz

Pack Weight  
pcs. kg/pcs.

Wiring diagram



600V	1000V	1200V		Type			
20A	-	-	2 HKA11	<b>K3DC-20A00 ...</b>	1	0,5	
50A	-	-	+1 HKT.	<b>K3DC-48A00 ...</b>	1	0,5	
60A	30A	-	2 HKA11	<b>K3DC-60A00...</b>	1	1,2	
80A	60A	-	+1 HKT.	<b>K3DC-80A00 ...</b>	1	1,2	
100A	-	-		<b>K3DC-100A00 ...</b>	1	1,8	
12A	12A	6A	2 HKA11 +2 HKT.	<b>K3PV-12A00 ...</b>	1	0,8	
30A	30A	-	2 HKA11	<b>K3PV-30A00 ...</b>	1	0,9	
60A	60A	-	+2 HKT.	<b>K3PV-60A00 ...</b>	1	0,9	
80A	80A	-	2 HKA11	<b>K3PV-80A00 ...</b>	1	1,5	
100A	100A	-	+1 HKT.	<b>K3PV-100A00 ...<sup>2)3)</sup></b>	1	2,3	
150A	150A	-	2 HKA11	<b>K3PV-150A00 ...<sup>2)3)</sup></b>	1	5	
200A	200A	-	+1 HKT.	<b>K3PV-200A00 ...<sup>2)3)</sup></b>	1	5	
240A	240A	-		<b>K3PV-240A00 ...<sup>2)3)</sup></b>	1	5	
300A	300A	-	2 HKA11	<b>K3PV-300A00 ...<sup>2)3)</sup></b>	1	7,5	
400A	400A	-	+1 HKT.	<b>K3PV-400A00 ...<sup>2)3)</sup></b>	1	7,5	
450A	450A	-		<b>K3PV-450A00 ...<sup>2)3)</sup></b>	1	7,5	

# Contactors for DC-Switching for PV-installations, as remote controlled fire protection defeat device

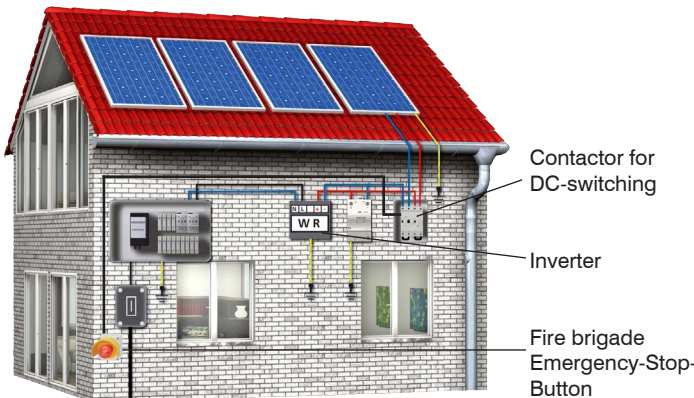

In most Photovoltaic-installations, the switch disconnectors according to IEC 60364-7-712 are integrated in the DC/AC-inverter. So the wires between solar-panels and inverter are continuously under voltage. According to ÖVE-R11-1: 2013, Photovoltaic-installations must have a fire protection defeat device. For this purpose, BENEDICT contactors for DC-switching, used as a fire protection defeat device, can switch off the Photovoltaic-installation with a remote controlled fire brigade Emergency-Stop-button.

Switch diagram (4 contacts)

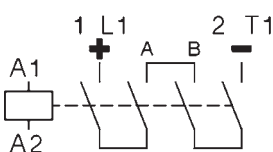

Connection diagram 1-pole

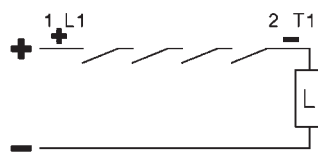



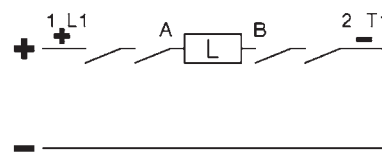





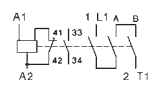

For using as two-poles contactor remove connection A-B

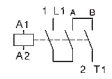

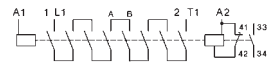

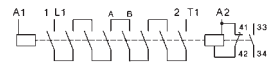

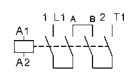
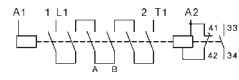
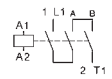
1) Other coil voltages from 24 to 600V AC, on request  
2) Type for AC- and DC-operating: e.g.: 230: 220-240V 50/60Hz and 220V=  
3) With integrated coil suppressor

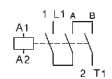
# Contactors for DC-Switching

DC-operated

Type	Coil voltage <sup>1)</sup>	Aux. Contacts		Pack pcs.	Weight kg/pcs.	Wiring diagram	
	24 24V= DC	build in NO NC	additional Type				
		1	-	1 HKA11	1	0,5	
<b>K3DC-48A10= ...<sup>5)</sup></b>		1	-	+1 HKT.	1	0,5	
		-	-	1 HKA11	1	1,2	
<b>K3DC-80A00= ...<sup>5)</sup></b>		-	-	+1 HKT.	1	1,2	
<b>K3DC-100A00= ...<sup>5)</sup></b>		-	-		1	1,8	
		1	-	1 HKA11 +2 HKT.	1	0,85	
<b>K3PV-30A10= ...<sup>5)</sup></b>		1	-	1 HKA11	1	0,95	
		1	-	+2 HKT.	1	0,95	
<b>K3PV-80A00= ...<sup>5)</sup></b>		-	-	2 HKA11	1	1,5	
		-	-	+1 HKT.	1	2,3	
<b>K3PV-150A00 ...<sup>2) 5)</sup></b>		-	-	2 HKA11	1	5	
		-	-	+1 HKT.	1	5	
<b>K3PV-240A00 ...<sup>2) 5)</sup></b>		-	-		1	5	
		-	-	2 HKA11	1	7,5	
<b>K3PV-400A00 ...<sup>2) 5)</sup></b>		-	-	+1 HKT.	1	7,5	
<b>K3PV-450A00 ...<sup>2) 5)</sup></b>		-	-		1	7,5	

## Auxiliary Contact Blocks for contactors K3DC-.. and K3PV-.., for low level switching<sup>4)</sup>

	Rated Operational Current			Type	Pack pcs.	Weight kg/pcs.	Wiring diagrams	
	AC15	AC15	AC1					
	230V	400V	690V					
	A	A	A	for contactors				
	<b>3</b>	2	10	K3DC, K3PV-.. top	<b>HKT11</b>	1	0,04	
	<b>3</b>	2	10	K3DC, K3PV-.. top	<b>HKT22</b>	1	0,05	
	<b>3</b>	2	10	K3DC, K3PV-.. top	<b>HKT31</b>	1	0,05	
	<b>3</b>	2	10	K3DC, K3PV-.. top	<b>HKT40</b>	1	0,05	
	<b>3</b>	2	10	K3DC, K3PV-.. side	<b>HKA11</b>	1	0,05	

## Accessories



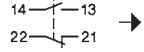











<b>Fire Brigade-EMERGENCY STOP key operated button</b> Ø40mm, according to EN418, unlock by key	<b>BG10P44S3-11 +SK</b>	1	0,22		3)
---	-------------------------	---	------	---	----

1) Other coil voltages from 24 to 250V DC, on request  
 2) Type for AC- and DC-operating: e.g.: 24: 24V 50/60Hz and 24V=  
 3) → opener positive opening acc. IEC/EN60947-5-1  
 4) Contacts suitable for electronic circuits, according to IEC60947-5-4 for rated voltage 24V DC (test ratings 17V DC, 5mA) Mirror contacts acc. IEC60947-4-1 Annex F. Technical data see page 78  
 5) With integrated coil suppressor

# Technical Data

Data according to IEC 60947-4-1, VDE 0660

Type		K3DC-20..	K3DC-48..	K3DC-60..	K3DC-80..	K3DC-100..	K3PV-12..	K3PV-30..	K3PV-60..	K3PV-80..	K3PV-100..	K3PV-150..	K3PV-200..	K3PV-240..	K3PV-300..	K3PV-400..	K3PV-450..	
Rated insulation voltage $U_{imp}$	V= kV	600 8	600 8	1000 8	1000 8	600 8	1200 8	1000 8	1000 8	1000 8	1000 8	1000 8	1000 8	1000 8	1000 8	1000 8	1000 8	
poles in series		3	3	3	3	3	8	6	6	4	4	3	3	3	3	3	3	
DC1 600V dc	$I_e$ A	20	50	60	80	100	12	30	60	80	100	150	200	240	300	400	450	
DC1 1000V dc	$I_e$ A	-	-	30	60	-	12	30	60	80	100	150	200	240	300	400	450	
DC1 1200V dc	$I_e$ A	-	-	-	-	-	6	-	-	-	-	-	-	-	-	-	-	
DC3/5 310V dc	$I_e$ A	-	-	-	40	60	-	15	24	40	90	125	170	200	230	270	300	
DC3/5 460V dc	$I_e$ A	-	-	-	-	-	-	15	24	40	40	125	170	200	230	270	300	
DC3/5 600V dc	$I_e$ A	-	-	-	-	-	-	-	-	-	-	50	60	75	120	160	200	
Main pole resistance	mOhm	1,8	1,8	1,4	1,2	1	2,2	1,8	1,8	1,2	1	0,5	0,5	0,35	0,15	0,15	0,15	
poles in series resistance	mOhm	5,4	5,4	4,2	3,6	3	17,6	10,8	10,8	4,8	4	1,5	1,5	1,1	0,5	0,5	0,5	
Mechanical life	$10^6$	10										10			8			
Protection degree		IP20										IP00 / IP20 <sup>1)</sup>			IP00 / IP20 <sup>1)</sup>			
Main poles																		
Cable cross sections	mm <sup>2</sup>	2 x 1,5 - 10		2,5 - 35		4 - 35 +4-50		2x 1,5-2,5		2 x 1,5 - 10		2,5-35		4 - 35 +4 - 50		Busbar 18 x 4 Screw M8		
Tightening torque	Nm	2,3 - 2,7		5 - 6		8 - 9,6		1,4 - 1,6		2,3 - 2,7		5 - 6		8 - 9,6		17 - 20		
Mounting		DIN-rail or screw				screws		DIN-rail or screws				Screws		Screws				
Operating range of coils	Uc	0,85 - 1,1																
Power consumption of coils																		
AC inrush sealed	VA VA/W	90 9 / 3		250 18 / 4		180 18 / 6		250 18 / 4		350 5 / 5		360 6 / 6						
DC inrush sealed	W W	120 2		230 4		230 5		230 4		350 5		360 6						
Switching time																		
AC make time	ms	10 - 25		12 - 30		12 - 30		10 - 25		12 - 30		15 - 50		30 - 60				
AC release time	ms	6 - 18		6 - 15		6 - 15		6 - 18		6 - 15		30 - 80		30 - 80				
DC make time	ms	15 - 25		15 - 25		20 - 30		15 - 25		15 - 25		15 - 50		30 - 60				
DC release time	ms	40 - 70		10 - 25		10 - 25		40 - 70		10 - 25		30 - 80		30 - 80				
Maximum ambient temperature																		
Operation °C		-40 to +40 (+70) <sup>2)</sup>																
Storage °C		-40 to +70																
Short circuit protection for contactors																		
Coordination-type „1“ max. fuse size gPV																		
600VDC A		63	80	-	-	160	-	-	-	-	-	160	200	250	-	-	-	
1000VDC A		-	-	-	-	-	12	63	100	-	160	160	200	250	315	400	500	
Coordination-type „2“ max. fuse size gPV																		
600VDC A		50	63	80	100	125	-	-	-	100	-	-	-	-	-	-	-	
1000VDC A		-	-	80	100	-	-	50	80	100	125	-	-	-	-	-	-	
Short-circuit current	kA	3	3	3	3	5	3	3	3	5	5	10	10	10	10	10	10	

Data according to UL60947-4-1 

Type		<b>LISTED</b>	K3DC-20..	K3DC-48..	K3DC-60..	K3DC-80..	K3PV-80..	K3PV-150..	K3PV-200..	K3PV-240..	K3PV-300..	K3PV-400..	K3PV-450..
General Use $I_e$ [A]	600V DC		20	40	60	80	80	130	160	200	300	330	360
	1000V DC		-	-	30	60	80	130	160	200	300	330	360
Motor Control $I_e$ [A]	220-240V DC		12	20	38	55	72	89	106	140	173	206	255
	500V DC		12	16	34	51	67	83	99	123	164	205	246
	550-600V DC		12	16	38	46	61	90	111	148	185	222	294

1) IP20 w. terminal lug.

2) > 40° ... 1% / °C de-rating (eg. at 60°C 20% de-rating)

# Dimensions

**K3DC-20A00, K3DC-48A00**

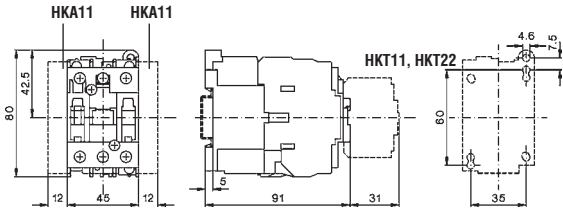

**K3DC-20A10=, K3DC-48A10=**

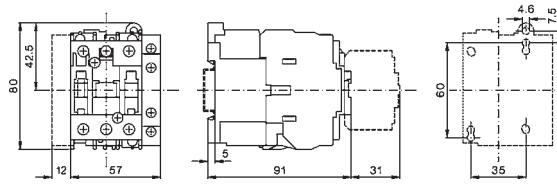

**K3DC-60A00(=), K3DC-80A00(=), K3DC-100A00(=)**

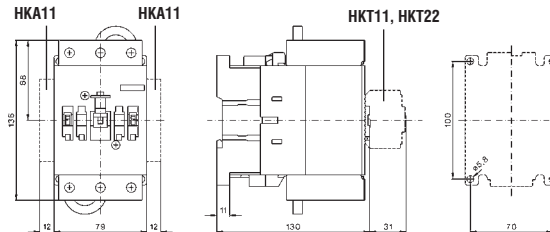
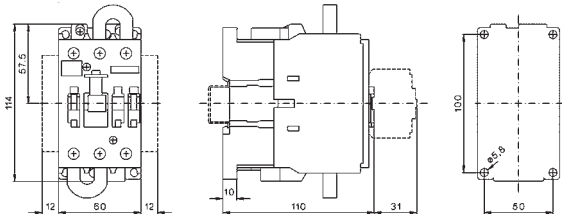

**K3PV-12A00**

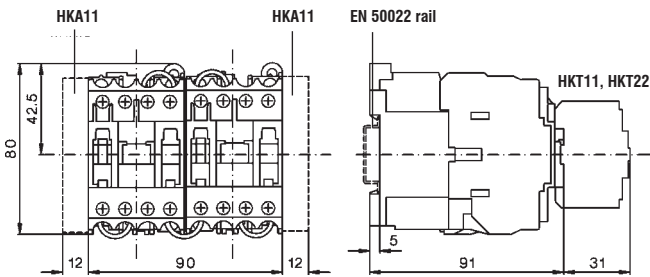

**K3PV-12A10=**

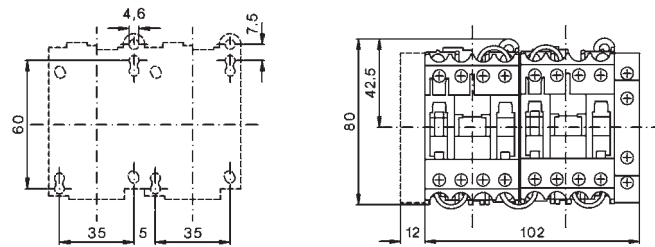

**K3PV-30A00, K3PV-60A00**

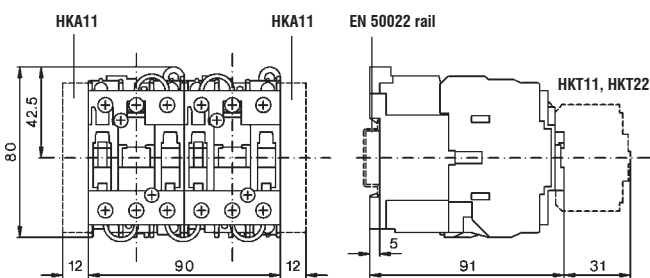

**K3PV-30A10=, K3PV-60A10=**

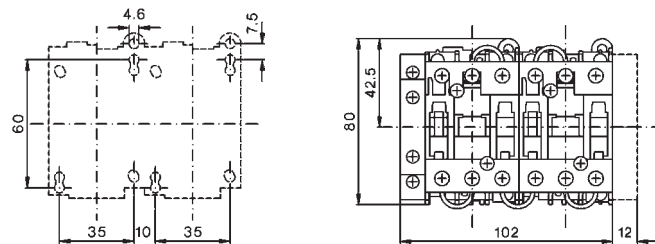

**K3PV-80A00(=)**

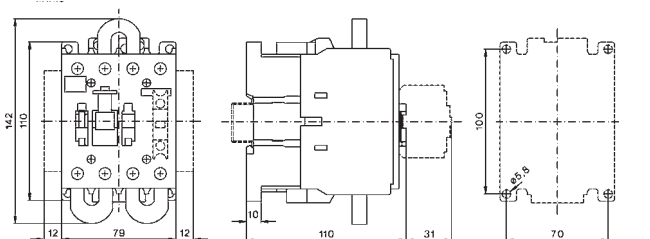

**K3PV-100A00(=)**

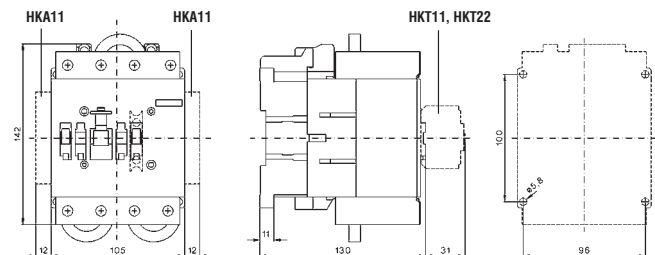

**K3PV-150A00(=), K3PV-200A00(=), K3PV-240A00(=)**

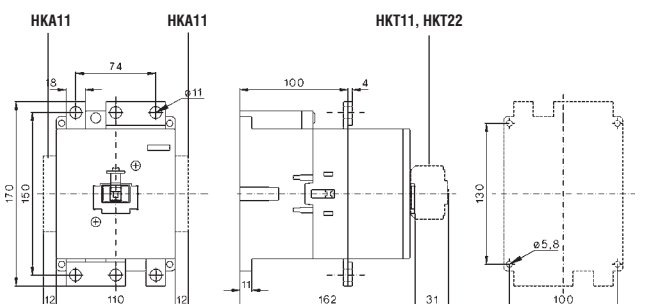

**K3PV-300A00(=), K3PV-400A00(=), K3PV-450A00(=)**

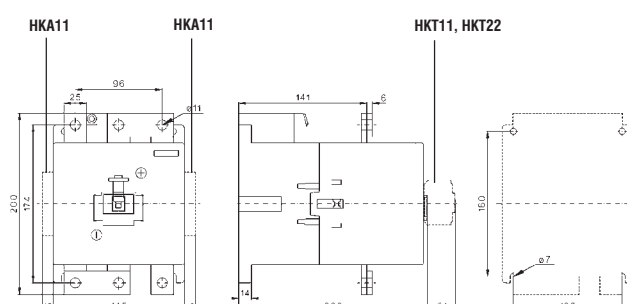

	<b>Contactors RAST 5</b> Contactor Relays Contactors	147 147 147
	<b>Accessories</b> Auxilliary Contact Blocks	147 147
	<b>Combinations</b> Contactors for Fuseless Load Feeder Contactors for Overload Relays	148 148 148
	<b>Industry Standard RAST 5</b> Contactor-Housing Coil-Housing Auxilliary Contact Block-Housing	149 150 157
	<b>System Stocko RAST 5</b> Contactor-Housing Coil-Housing Auxilliary Contact Block-Housing	151 152 158
	<b>System Tyco RAST 5</b> Contactor-Housing Coil-Housing Auxilliary Contact Block-Housing	153 154 159
	<b>System Lumberg RAST 5</b> Contactor-Housing Coil-Housing Auxilliary Contact Block-Housing	155 156 160
	<b>Dimensions / Color Codes</b>	161
	<b>Technical Information</b>	162



# RAST 5 - exclusiv for OEM-Partner

5 mm pitch connector system

## Advantages RAST 5 - Technology

- Time saving installation
- Easy assembly without tools
- Tailor-made sockets, custom - designed codes
- Ambient temperatures up to +90°C/194°F
- Smallest sizes
- Plug technology up to 32 A / 415 V
- color coding for power ratings
- color coding for coil voltages

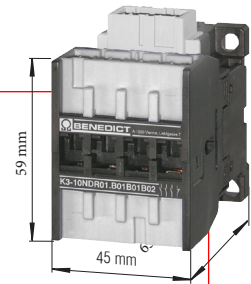

## RAST 5 - Accessories



Combining switchgears with plug-in connections and screw connections

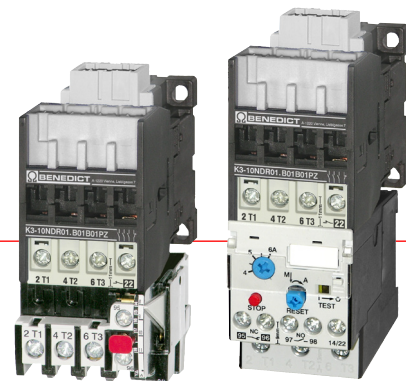



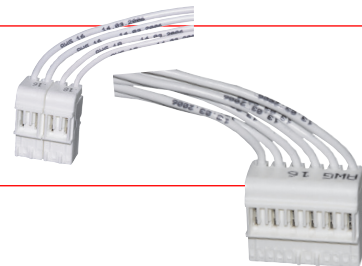

Contactors are available for plugs of many different producers



# Contactors, RAST 5

AC operated

Ratings AC2, AC3 380V 400V 415V <b>kW</b>	220V 230V kW	240V kW	Rated- Current AC1 415V A	Auxilliary Contacts built in		Auxilliary Contacts snap on HN10R..	Type	Coil Voltage	Code Housing Coil	Code Housing IN (L)	Code Housing OUT (T)	Pack pcs.	Weight kg/pc.
				NO	NC								
<b>● Contactor Relays</b>													
	-	-	10	4	-	2	<b>K3-07NDR40</b>					1	0,23
	-	-	10	2	2	2	<b>K3-07NDR22</b>					1	0,23
<b>● Contactors</b>													
	<b>4</b>	3	3	25	1	-	2	<b>K3-10NDR10</b>				1	0,23
	<b>4</b>	3	3	25	-	1	2	<b>K3-10NDR01</b>				1	0,23
	<b>5,5</b>	4	4	25	1	-	2	<b>K3-14NDR10</b>				1	0,23
	<b>5,5</b>	4	4	25	-	1	2	<b>K3-14NDR01</b>				1	0,23
	<b>7,5</b>	5	5	32	1	-	2	<b>K3-18NDR10</b>				1	0,23
	<b>7,5</b>	5	5	32	-	1	2	<b>K3-18NDR01</b>				1	0,23
	<b>11</b>	6	7	32	1	-	2	<b>K3-22NDR10</b>				1	0,23
	<b>11</b>	6	7	32	-	1	2	<b>K3-22NDR01</b>				1	0,23

## Auxilliary

● Auxilliary Contact Blocks		for Contactors		AC15 230V A	I <sub>th</sub> A	Contacts		Type	Pack pcs.	Weight kg/pc.
				A	A	NO	NC			
	K3-..R..	3	10	1	-	<b>HN10R</b>		10	0,02	
	K3-..R..	3	10	-	1	<b>HN01R</b>		10	0,02	

Order Example for Contactors:

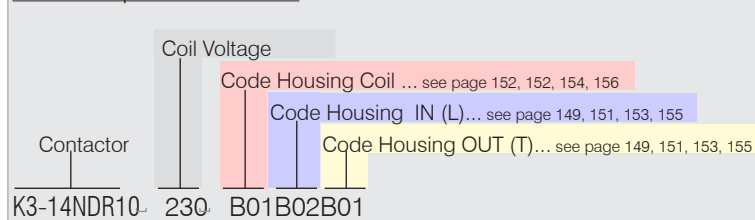

Technical data are subject to change without notice

# Contactors, RAST 5 Combinations

AC operated

Motor  
 AC2, AC3  
 380V AC3  
 400V 400V  
 415V 415V  
**kW A**



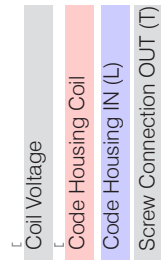

for  
 Overload Relays  
 U12/16E.. and U3/32...

## Type



Pack Weight  
 pcs. kg/pcs.

● Contactors for Overload Relays

	4	10	U12/16E 0,18-..23 K3 and U3/32 0,18-..32	<b>K3-10NDR10</b>	..	..	..	<b>PZ</b>	1	0,23
	4	10	U12/16E 0,18-..23 K3 and U3/32 0,18-..32	<b>K3-10NDR01</b>	..	..	..	<b>PZ</b>	1	0,23
	5,5	14	U12/16E 0,18-..23 K3 and U3/32 0,18-..32	<b>K3-14NDR10</b>	..	..	..	<b>PZ</b>	1	0,23
	5,5	14	U12/16E 0,18-..23 K3 and U3/32 0,18-..32	<b>K3-14NDR01</b>	..	..	..	<b>PZ</b>	1	0,23
	7,5	18	U12/16E 0,18-..23 K3 and U3/32 0,18-..32	<b>K3-18NDR10</b>	..	..	..	<b>PZ</b>	1	0,23
	7,5	18	U12/16E 0,18-..23 K3 and U3/32 0,18-..32	<b>K3-18NDR01</b>	..	..	..	<b>PZ</b>	1	0,23
	11	22	U12/16E 0,18-..23 K3 and U3/32 0,18-..32	<b>K3-22NDR10</b>	..	..	..	<b>PZ</b>	1	0,23
	11	22	U12/16E 0,18-..23 K3 and U3/32 0,18-..32	<b>K3-22NDR01</b>	..	..	..	<b>PZ</b>	1	0,23

Pozidriv ... PZ  
 Torx ..... TX

Selection of Contactor-Housings for Standard plugs acc. **Industry Standard RAST 5**



Contactor Housings

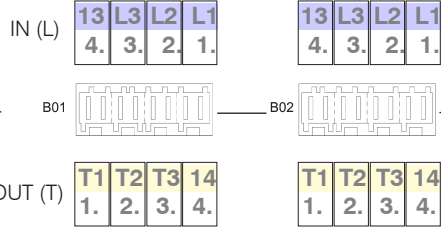

**Code Contactor-Housings** — B01 — B02 — B03 — B04 further housings on request →

**Standard plugs acc. Industry Standard RAST 5**



	B01	B02	B03	B04
8-pole				
6-pole left				
6-pole right				
4-pole left		-0A-		
4-pole right		-0B-		-0B-
2-pole left				-0A- -0C- -0I- -0L- -0O- -0Q-
2-pole center left		-0A- -0C-		-0K-
		-0O- -0Q-		
2-pole center right				-0B- -0F- -0K- -0L-
2-pole right				-0B- -0F- -0I- -0L-

Order Example for Contactors:

Contactor — K3-14NR10  
 Coil Voltage — U<sub>230</sub>  
 Code Housing Coil ...see page 150, 152, 154, 156 — B01  
 Code Housing IN (L)... see page 149, 151, 153, 155 — B02  
 Code Housing OUT (T)...see page 149, 151, 153, 155 — B01

Selection of Coil-Housings for Standard plugs acc. **Industry Standard RAST 5**



Coil-Housings

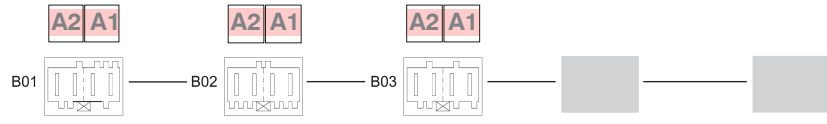

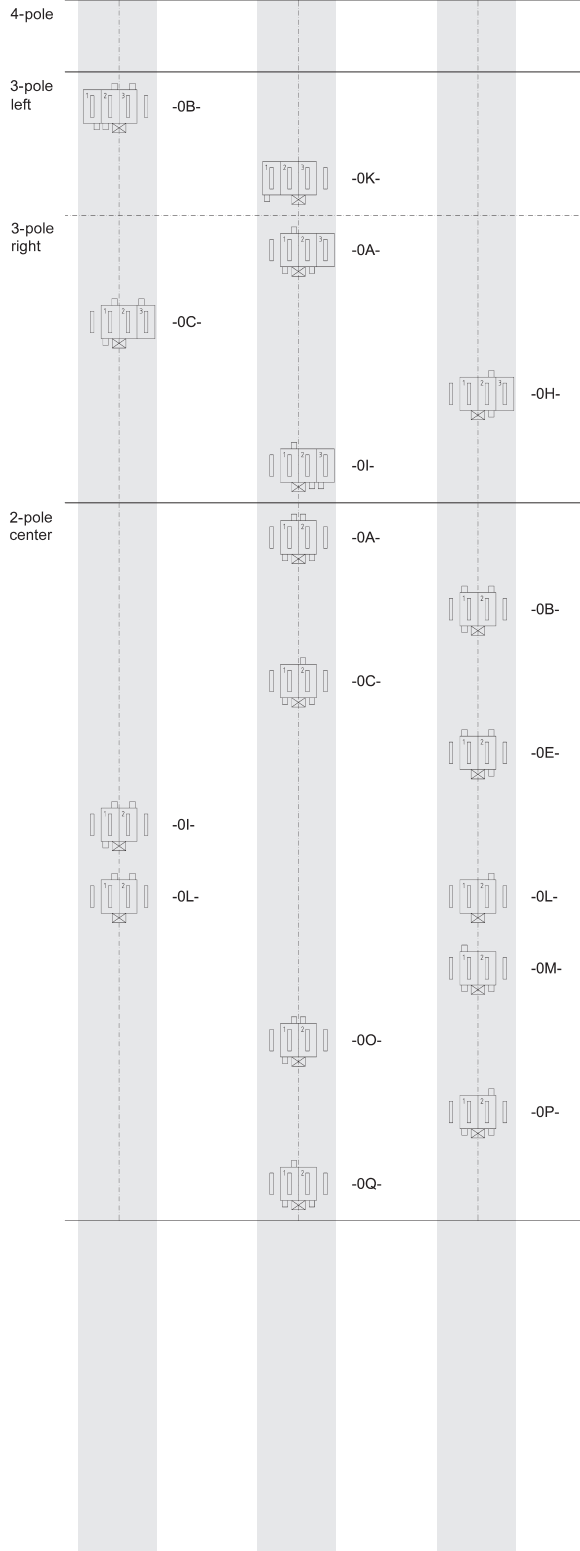

**Code Coil-Housings** ————— **B01** ————— **B02** ————— **B03** ————— **B04** ————— **B05** ————— further housings on request →

**Standard plugs acc. Industry Standard RAST 5**

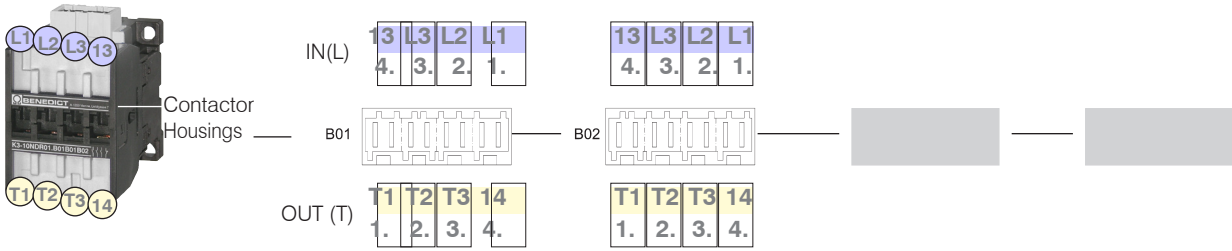

Selection of Contactor-Housings for Standard plugs acc. **System Stocko RAST 5**



Code Contactor-Housings		B01	B02	B03	B04	further housings on request ▶	
<b>Standard plugs acc. System Stocko RAST 5</b>  	8-pole					-31-	
	6-pole left						-34-
							-35-
							-38-
							-50-
							-65-
							-1F-
	6-pole right						-34-
							-35-
							-38-
							-50-
							-65-
							-1F-
	4-pole left						-14-
							-16-
							-53-
							-60-
							-73-
						-75-	
4-pole right						-10-	
						-60-	
2-pole		see...	Industry Standard RAST 5				

Order Example for Contactors:

Contactor  
 Coil Voltage  
 Code Housing Coil ...see page 150, 152, 154, 156  
 Code Housing IN (L)... see page 149, 151, 153, 155  
 Code Housing OUT (T)...see page 149, 151, 153, 155

K3-14NR10\_230\_B01 B02 B01



# Selection of Contactor-Housings for Standard plugs acc. **System Tyco RAST 5**



Contactor Housings

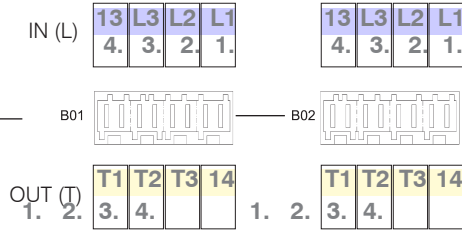

## Code Contactor-Housings — B01 — B02 — B03 — B04 further housings on request ▶

Standard plugs acc. System Tyco RAST 5



	B01	B02	B03	B04 further housings on request ▶
8-pole				
6-pole left		928151-6 2-928344-6		
6-pole right				
4-pole left		928344-4		4-928344-4
4-pole right				
2-pole left				928344-2 3-964951-2
		2-964951-2 928343-2		
				964951-2 4-928344-2
2-pole center left		928344-2		
		3-964951-2 4-928344-2		
2-pole center right				2-928344-2 928343-2
2-pole right				2-928344-2 2-964951-2 928343-2 928343-2

Order Example for Contactors:

Contactor	Coil Voltage	Code Housing Coil ...see page 150, 152, 154, 156	Code Housing IN (L)... see page 149, 151, 153, 155	Code Housing OUT (T)...see page 149, 151, 153, 155
K3-14NR10	230	B01	B02	B01



Selection of Coil-Housings for Standard plugs acc. **System Tyco RAST 5**



Coil  
Housings –

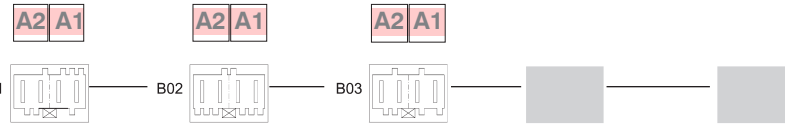

Code Coil-Housings	B01	B02	B03	B04	B05	further housings on request
4-pole						
3-pole left						
3-pole right						
2-pole center						

Standard plugs  
acc.  
System Lumberg RAST 5



# Selection of Contactor-Housings for Standard plugs acc. **System Lumberg RAST 5**

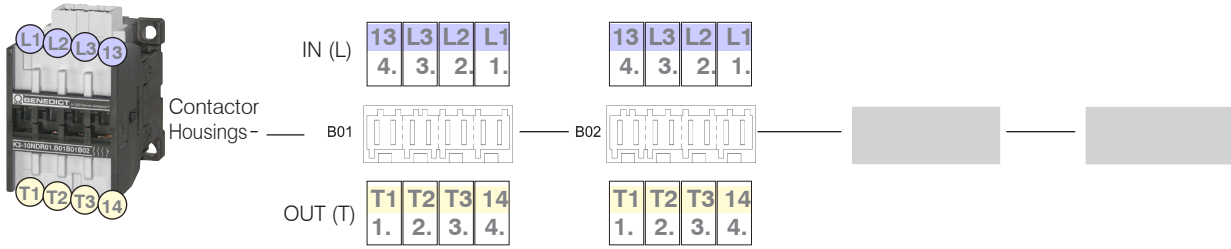

## Code Contactor-Housings B01 B02 B03 B04 further housings on request

Standard plugs acc. System Lumberg RAST 5



	B01	B02	B03	B04
8-pole				
6-pole left				-10-
6-pole right				
4-pole left				-01-
4-pole right				-02-
2-pole left				-01- -03-
2-pole center left				-01- -03-
2-pole center right				-10- -02- -06-
2-pole right				-02- -06- -09-

Order Example for Contactors:

Contactor	K3-14NR10
Coil Voltage	230
Code Housing Coil ...see page 150, 152, 154, 156	B01
Code Housing IN (L)... see page 149, 151, 153, 155	B02
Code Housing OUT (T)...see page 149, 151, 153, 155	B01

Selection of Coil-Housings for Standard plugs acc. **System Lumberg RAST 5**



Coil  
Housings –

B01

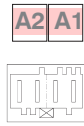

B02

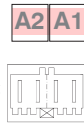

B03



**Code Coil-Housings**

**B01**

**B02**

**B03**

**B04**

**B05**

further housings  
on request →

**Standard plugs  
acc.  
System Lumberg RAST 5**

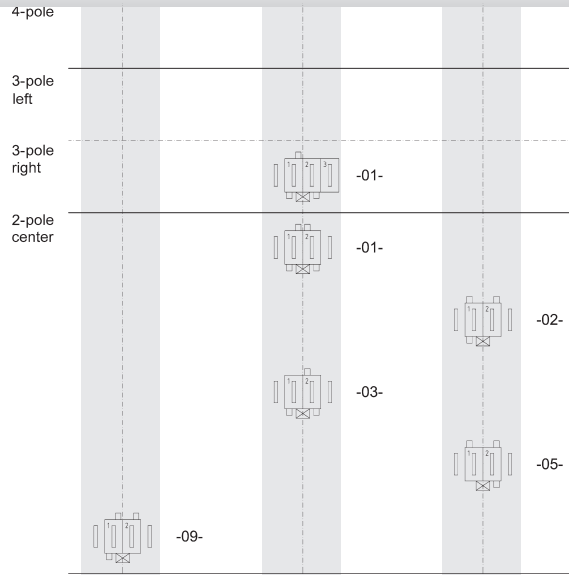

Selection of Auxiliary Contact Block-Housings for Standard plugs acc. **Industry Standard RAST 5**



Auxiliary Contact Block-Housings

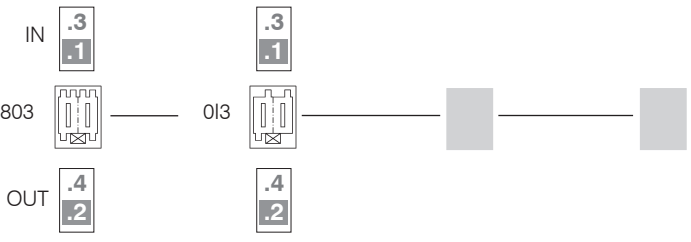

**Code Auxilliary-Contact Block-Housings**

Standard plugs acc. Industry Standard RAST 5

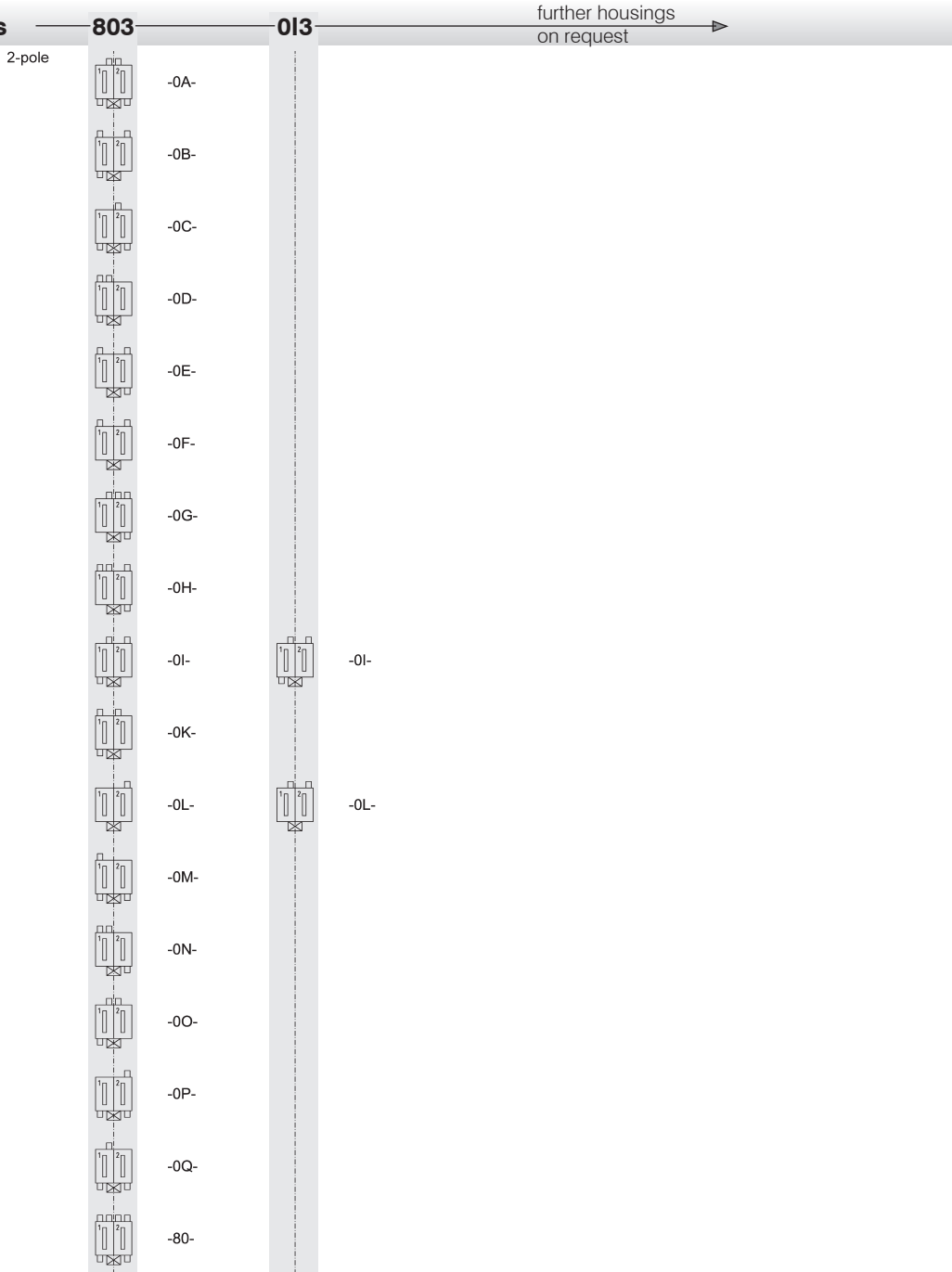

Order Example for Aux. Contact Blocks:

- Auxilliary Contact Block
  - Code Aux. Block Housing IN (1,3)
  - Code Aux. Block Housing OUT (2,4)
- HN10R-803013

Selection of Auxiliary Contact Block-Housings for Standard plugs acc. **System Stocko RAST 5**

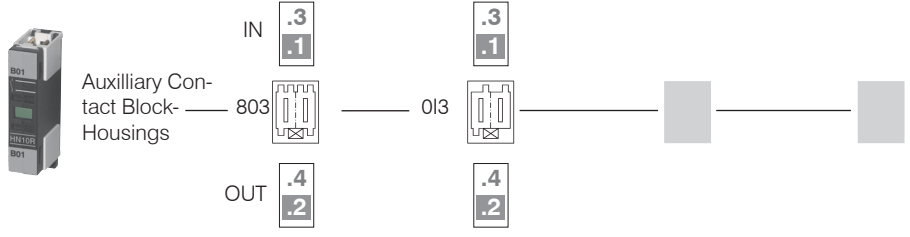

**Code Auxilliary-Contact Block-Housings**

Standard plugs  
acc.  
System Stocko RAST 5

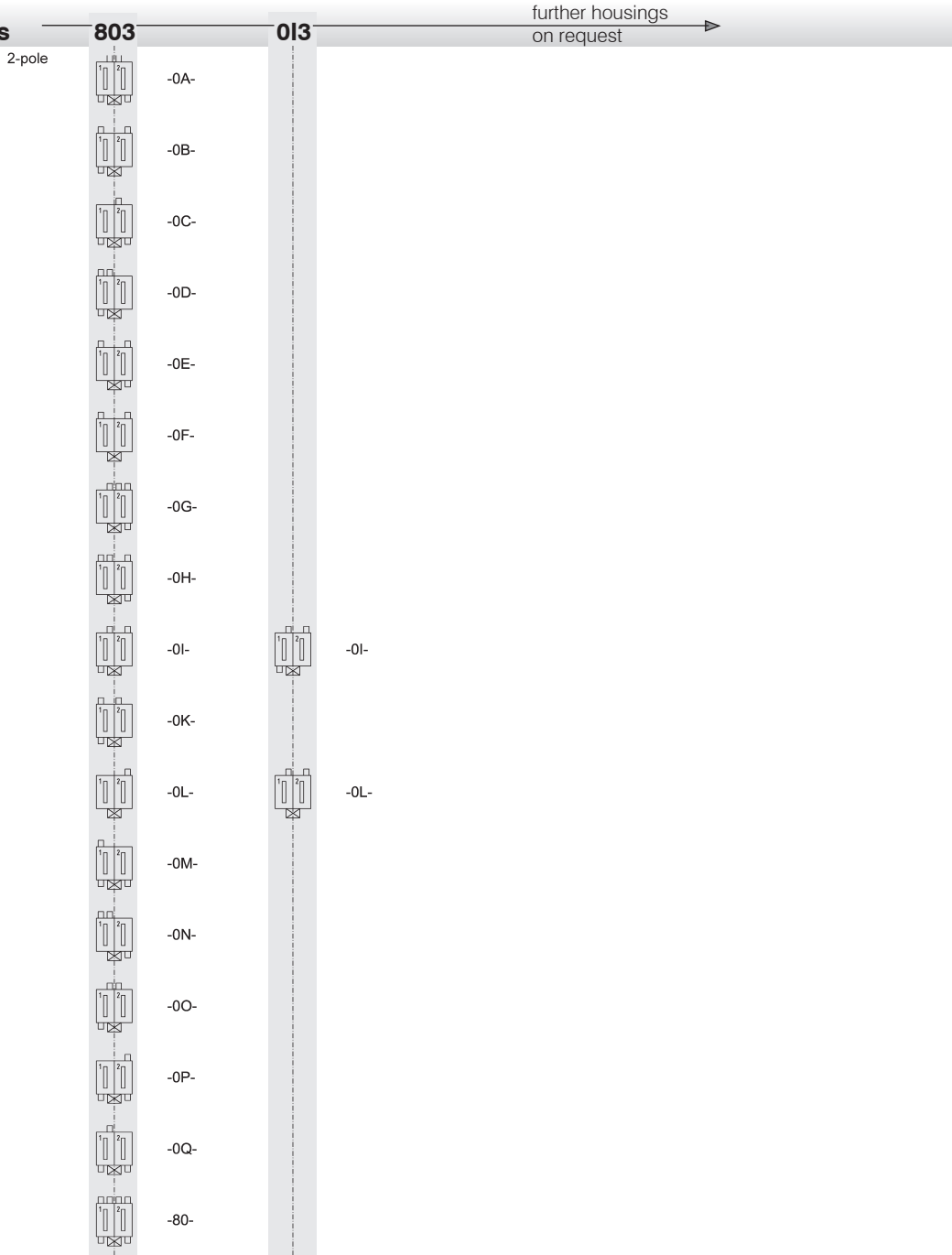

Order Example for  
Aux. Contact Blocks:

- Auxiliary Contact Block
- Code Aux. Block Housing IN (1,3)
- Code Aux. Block Housing OUT (2,4)

HN10R 803013

Selection of Auxiliary Contact Block-Housings for Standard plugs acc. **System Tyco RAST 5**

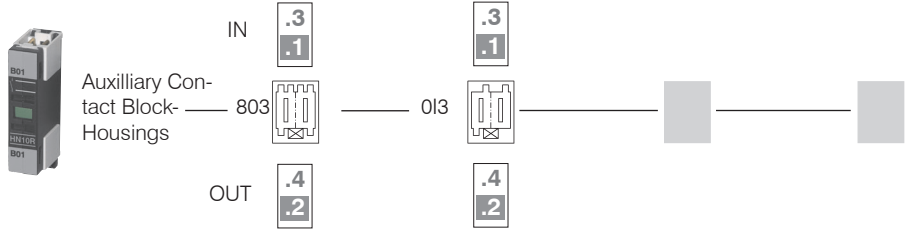

**Code Auxilliary-Contact Block-Housings**

**803**      **013**      further housings on request →

**Standard plugs acc. System Tyco RAST 5**



2-pole	803	013
	928344-2	
	2-928344-2	
	3-964951-2	
	6-928344-2	
	5-928344-2	
	3-928344-2	
	2-964951-2	2-964951-2
	928343-2	928343-2
	964951-2	
	4-928344-2	

Order Example for  
Aux. Contact Blocks:

—Auxiliary Contact Block  
—Code Aux. Block Housing IN (**1**,**3**)  
—Code Aux. Block Housing OUT (**2**,**4**)  
HN10R-803013

Selection of Auxiliary Contact Block-Housings for Standard plugs acc. **System Lumberg RAST 5**

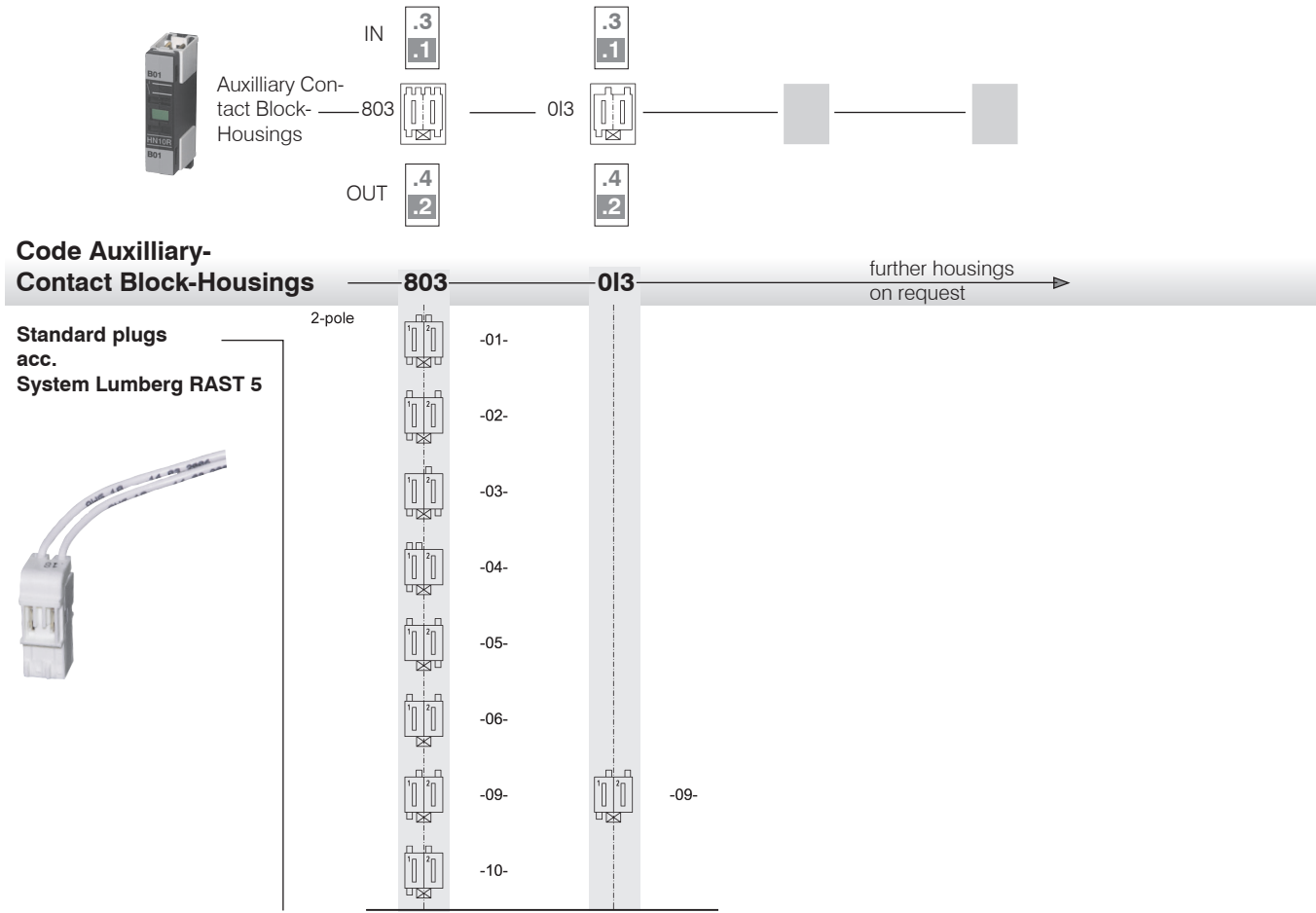

Order Example for  
Aux. Contact Blocks:

- Auxiliary Contact Block
- Code Aux. Block Housing IN (1,3)
- Code Aux. Block Housing OUT (2,4)

HN10R 803013

Data acc. to IEC 60947-4-1, VDE 0660

Main Contacts		Type	K3-07NDR	K3-10NDR	K3-14NDR	K3-18NDR	K3-22NDR
<b>Rated insulation voltage <math>U_i</math></b> <sup>1)</sup>		V~	415	415	415	415	415
<b>Making capacity <math>I_{eff}</math></b>	at $U_e = 415V\sim$	A	-	200	200	200	200
<b>Breaking capacity <math>I_{eff}</math></b>	at $U_e = 415V\sim$ $\cos\varphi = 0,65$	A	-	180	180	200	200
<b>Utilization category AC1</b>							
<b>Switching of resistive load</b>							
Rated operational current $I_e (=I_{th})$	415V	<b>A</b>	<b>10</b>	<b>25</b>	<b>25</b>	<b>32</b>	<b>32</b>
Rated operation power	220V	kW	-	9,5	9,5	12,2	12,2
of three-phase resistive loads	230V	kW	-	9,9	9,9	12,7	12,7
50-60Hz, $\cos\varphi = 1$	240V	kW	-	10,4	10,4	13,3	13,3
	380V	kW	-	16,4	16,4	21,0	21,0
	400V	kW	-	17,3	17,3	22,1	22,1
	415V	kW	-	17,9	17,9	23,0	23,0
Rated operational current $I_e (=I_{th})$	415V	A	6	25	25	32	32
at 60°C, enclosed	220V	kW	-	9,5	9,5	12,2	12,2
Rated operational power	230V	kW	-	9,9	9,9	12,7	12,7
of three-phase resistive loads	240V	kW	-	10,4	10,4	13,3	13,3
50-60Hz, $\cos\varphi = 1$	380V	kW	-	16,4	16,4	21,0	21,0
	400V	kW	-	17,3	17,3	22,1	22,1
	415V	kW	-	17,9	17,9	23,0	23,0
Minimum cross-section of conductor		mm <sup>2</sup>	2 x 1,5 <sup>2</sup>	2 x 1,5 <sup>2</sup>	2 x 1,5 <sup>2</sup>	2 x 2,5 <sup>2</sup>	2 x 2,5 <sup>2</sup>
at load with $I_e (=I_{th})$							
<b>Utilization category AC2 and AC3</b>							
<b>Switching of three-phase motors</b>							
Rated operational current $I_e$	220V	A	-	12	15	18	22
open and enclosed	230V	A	-	11,5	14,5	18	22
	240V	A	-	11	14	18	22
	<b>380-400V</b>	<b>A</b>	<b>-</b>	<b>10</b>	<b>14</b>	<b>18</b>	<b>22</b>
	415V	A	-	9	14	18	22
Rated operational power	220-230V	kW	-	3	4	5	6
of three-phase motors	240V	kW	-	3	4	5	7
50-60Hz	<b>380-400V</b>	<b>kW</b>	<b>-</b>	<b>4</b>	<b>5,5</b>	<b>7,5</b>	<b>11</b>
	415V	kW	-	4,5	6	8,5	12
<b>Auxilliary Contacts</b>							
<b>Rated insulation voltage <math>U_i</math></b>		V~	415	415	415	415	415
<b>Thermal rated current <math>I_{th}</math></b> up to 415V							
Ambient temperature	40°C	A	10	10	10	10	10
	60°C	A	6	6	6	6	6
<b>Utilization category AC15</b>							
Rated operational current $I_e$	220-240V	A	3	3	3	3	3
	380-415V	A	2	2	2	2	2
<b>Utilization category DC13</b>							
Rated operational current $I_e$	60V	A	3,5	3,5	3,5	3,5	3,5
	110V	A	0,5	0,5	0,5	0,5	0,5
	220V	A	0,1	0,1	0,1	0,1	0,1
<b>Short circuit protection</b>	gL (gG)	A	20	20	20	20	20

1) Suitable for: earthed -neutral systems, overvoltage category I to III, pollution degree 3 (Industry-Standard):  $U_{imp} = 4kV$ .  
Data for other conditions on request.



Data acc. to IEC 60947-4-1, VDE 0660

Main Contacts		Type	K3-07NDR	K3-10NDR	K3-14NDR	K3-18NDR	K3-22NDR	
<b>Maximum ambient temperature</b>								
Operation	open	°C	-40 up to +60 (+90) <sup>1)</sup>					
	enclosed	°C	-40 up to +40					
	with thermal overload relay	open	°C	-25 up to +60				
		enclosed	°C	-25 up to +40				
Storage		°C	-50 up to +90					
<b>Short circuit protection</b>								
for contactors without thermal overload relay								
Coordination-Type „1“ acc. to IEC 947-4-1, Contact welding without hazard of persons								
max. fuse size	gL (gG)	A	20	63	63	63	63	
Coordination-Type „2“ acc. to IEC 947-4-1, light Contact welding accepted								
max. fuse size	gL (gG)	A		25	35	35	35	
Contact welding not accepted								
max. fuse size	gL (gG)	A		16	16	16	16	
for Contactors with thermal overload relay the device with the smaller admissible backup fuse (contactor or thermal overload relay) determines the fuse size.								
<b>Frequency of operations z</b>								
Contactors without thermal overload relay								
	without load	1/h	10000	10000	10000	10000	10000	
	AC3, I <sub>e</sub>	1/h		600	600	600	600	
	AC4, I <sub>e</sub>	1/h		120	120	120	120	
	DC3, I <sub>e</sub>	1/h		600	600	600	600	
<b>Mechanical life</b>								
AC-operated		S x 10 <sup>6</sup>	10	10	10	10	10	
DC-operated		S x 10 <sup>6</sup>	10	10	10	10	10	
<b>Short time current</b>	10sec.-current	A		96	120	144	176	
<b>Power loss</b> per pole	at I <sub>g</sub> /AC3 400V	W		0,21	0,35	0,5	0,75	
<b>Resistance to shock acc. to IEC 68-2-27</b>								
Shock time 20ms sine-wave	NO	g				10		
	NC	g				6		
<b>Control Circuit</b>								
<b>Power consumption of coils</b>								
AC operated	inrush	VA	33-45					
		VA	7-10					
		W	2,6-3					
DC operated	inrush	W	75					
	sealed	W	2					
<b>Operating range of coils</b>								
in multiples of control voltage U <sub>s</sub>								
	AC operated		0,85-1,1					
	DC operated		0,8-1,1					
<b>Switching time</b> at control voltage U <sub>s</sub> ± 10% <sup>2) 3)</sup>								
AC operated	make time	ms	8-16					
	release time	ms	5-13					
	arc duration	ms	10-15					
DC operated	make time	ms	8-12					
	release time	ms	8-13					
	arc duration	ms	10-15					

1) With reduced control voltage range 0,9 bis 1,0 x U<sub>s</sub> and with reduced rated current I<sub>g</sub> /AC1 acc. to I<sub>g</sub> /AC3

2) Total breaking time = release time + arc duration

3) Values for delay of the release time of the make contact and the make time of the break contact will be increased, if magnet coils are protected with coil suppressor (Varistor, RC-Unit, Diode-Unit).

Data acc. to UL508

Main Contacts (cULus)		Type	K3-10NDR	K3-14NDR	K3-18NDR	K3-22NDR
Bemessungsbetriebsstrom „General Use“		A	25	25	30	30
<b>Motor DOL 3-phase at 60Hz</b>						
Rated operational current	415V	A	10	14	18	22
Rated operational power	110-120V	hp	1½	2	2	3
	200-208V	hp	3	3	5	5
	220-240V	hp	3	3	5	5
	265-277V	hp	3	5	7½	7½
	380-415V	hp	5	5	10	10
<b>Motor DOL 1-phase at 60Hz</b>						
Rated operational current	415V	A	10	14	18	22
Rated operational power of AC motor at 60Hz (1ph)	110-120V	hp	½	¾	1	1½
	200-208V	hp	1	1½	2	3
	220-240V	hp	1½	2	3	3
	265-277V	hp	2	3	3	3
	380-415V	hp	3	3	5	5
Fuses Suitable for use on a capability of delivering not more than (SCCR)		A	30	40	50	50
rms		A	5000	5000	5000	5000
		V	415	415	415	415
Auxilliary Contacts (cULus)			A300	A300	A300	A300

## Accessories

Data acc. to IEC 60947-5-1, VDE 0660

Auxilliary Contacts		Type	HN10R	HN01R	
<b>Rated insulation voltage <math>U_i</math></b>		V~	415	415	
<b>Thermal rated current <math>I_{th}</math></b> up to 415V Ambient temperature	max. 40°C	A	10	10	
	max. 60°C	A	6	6	
<b>Frequency of operations z</b>		1/h	3000	3000	
<b>Mechanical life</b>		S x 10 <sup>6</sup>	10	10	
<b>Power loss</b> per pole at $I_e/AC1$		W	0,5	0,5	
<b>Utilization category AC15</b>					
Rated operational	220-240V	A	3	3	
betriebsstrom $I_e$	380-415V	A	2	2	
<b>Utilization category DC13</b>					
Bemessungs- current $I_e$	60V	A	2	2	
	110V	A	0,4	0,4	
	220V	A	0,1	0,1	
<b>Short circuit protection</b> short circuit current 1kA, contact welding not accepted max. fuse size		gL (gG)	A	20	20

Data acc. to UL508

Rated operational current „General Use“		A	10	10
Rated operational voltage	max.	V~	300	300
<b>Auxiliary Contacts</b>			A300	A300

# Dimensions

## K3-..NDR.. +HN..R

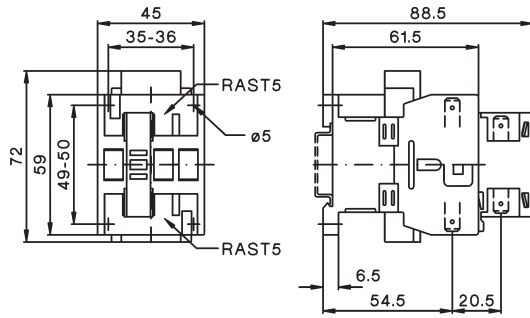

## K3-..NDR.....PZ + U3/32..

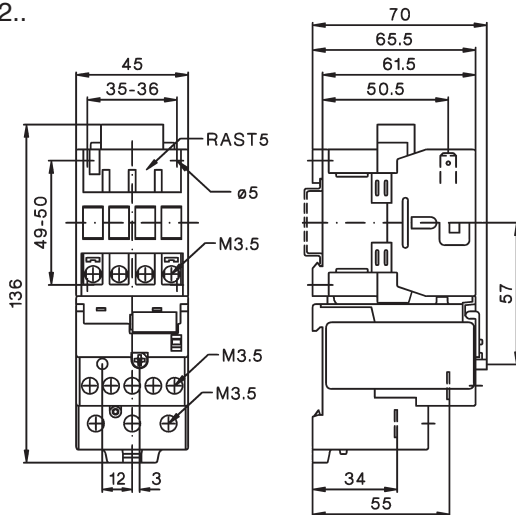

## K3-..NDR.....PZ + U12/16E..K3

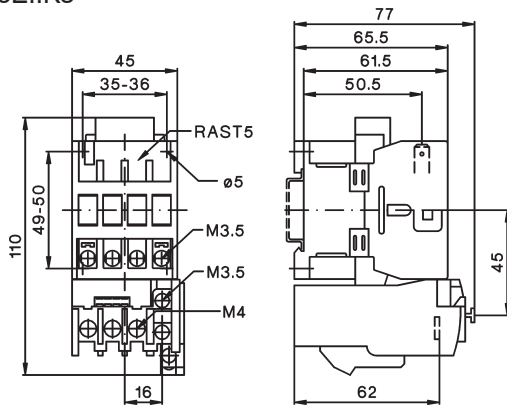

Technical data are subject to change without notice